

PRINCIPLES OF MERCURY ARC RECTIFIERS AND THEIR CIRCUITS

BY

DAVID CHANDLER PRINCE

*Research Engineer, General Electric Company,
Fellow, American Institute of Electrical Engineers*

AND

FRANCIS BROOKE VOGDES

Research Laboratory, General Electric Company

FIRST EDITION

McGRAW-HILL BOOK COMPANY, INC.

NEW YORK: 370 SEVENTH AVENUE

LONDON: 6 & 8 BOUVERIE ST.; E. C. 4

1927

COPYRIGHT, 1927, BY THE
MCGRAW-HILL BOOK COMPANY, INC.

PRINTED IN THE UNITED STATES OF AMERICA

THE MAPLE PRESS COMPANY, YORK, PA.

PREFACE

The study of rectifiers divides naturally into two parts: first, the consideration of the rectifiers themselves and, second, the study of the circuits in which they operate. These two subjects may be almost entirely separated for discussion, and yet in practice problems of both types continually appear together for solution. For this reason, this book consists of two parts, each of which is so arranged as to be independent of the other. They may, therefore, be studied simultaneously, or either section consulted by itself, if a particular problem is to be solved.

The authors have used a treatment which appears to them to be suited especially to American engineering practice. The usual condensation of mathematical work, for the sake of having it appear in a concise form, results in the adoption of special methods behind which the problem to be solved becomes almost totally obscured. The present writers, therefore, have not limited themselves in the amount of space to be used, but have instead picked out such mathematical processes as best set forth, to their minds, the physical conceptions of the problems discussed, and this usually results in the elimination of lengthy algebraic transformations. Mathematics is thus treated as a useful tool and is considered neither as the end to be attained nor as a weakness to be concealed.

The first part of the book begins with a discussion of the physics of several simple types of rectifiers and ends with the mercury arc rectifier. In this section, the authors have included the results of the labors of many workers as well as a description of their own work.

No attempt is made to describe all the various types of rectifiers which are in use. The principal object is to give as clear an explanation of the action of the mercury arc

rectifier as possible, and the other rectifiers which are discussed are considered because they illustrate in a striking manner certain phenomena occurring in the mercury device. This is necessary because the operation of the mercury arc rectifier is not completely understood and it is therefore desirable to set forth all the known facts in as clear a manner as possible in order that a firm basis may be available for constructive thought.

In the second part of the book, the authors have made use of a mathematical paper of exceptional value by Walter Dällenbach and Eduard Gerecke on the "Current and Voltage Conditions in the High Capacity Rectifier," published in the *Archiv für Elektrotechnik*.¹ This is the first paper, to the authors' knowledge, in which simultaneous conduction of current by more than two anodes is considered. The most complete part of the paper deals with this condition in a rectifier circuit having all the reactance in the secondary windings, and the method is indicated whereby more difficult problems can be solved.

Chapter IX, in the second part of the book, deals with the secondary-reactance case considered by Dällenbach and Gerecke, but the treatment, while fundamentally the same, has been revised in such a way as to shorten the discussion and eliminate a considerable part of the mathematics by placing more emphasis on the physical aspects of the problem. The remaining chapters of the book deal with more involved problems which unfortunately predominate in high-power rectifier practice. These are solved in a practical form by careful selection of the mathematical processes used and by picking the problems to be solved in such a way that their solutions will be useful and the work necessary will not become so involved as to make difficult a clear conception of what actually occurs.

Some of the symbols used in the discussion of rectifier circuits will probably appear unusual and may meet with disapproval. A great deal of confusion would be avoided by the adoption of some standard nomenclature for recti-

¹ Vol. 14, No. 2, pp. 171-246, 1924.

fiers. Where circuits are so complex, new symbols (particularly J for output current and G for output voltage) which have a distinct and clear-cut meaning are extremely useful.

No attempt has been made to discuss the details of rectifiers as constructed by the various manufacturers at present or the conditions under which they may be operating. Sufficient illustrations of apparatus have been picked to show the result of theory in practice rather than to give a comprehensive idea of commercial practice.

D. C. P.

F. B. V.

RESEARCH LABORATORY,
GENERAL ELECTRIC COMPANY,
SCHENECTADY, NEW YORK,
October, 1926.

CONTENTS

PREFACE.	PAGE V
------------------	-----------

PART I

MERCURY ARC AND THERMIONIC RECTIFIERS

CHAPTER

I. Kenotron Rectifiers.	3
II. Tungar Rectifiers.	15
III. Construction of Mercury Arc Rectifiers	23
IV. Theory of Mercury Arc Rectifiers.	38
V. Some Physical Properties of Mercury Arc Rectifiers.	47
VI. Arc-back of Mercury Arc Rectifiers.	64

PART II

POWER RECTIFIER CIRCUITS

VII. Fundamental Wave Shapes of Rectifiers, Ideal Cases with Impedanceless Transformers	83
VIII. Regulation of Rectifiers Due to Reactance, General Methods of Attacking Problem	108
IX. Regulation of Rectifiers Having all Their Reactance in Secondary Windings	136
X. Regulation of Double Three-phase Rectifiers with Reactance in the Primaries or Supply Lines	154
XI. Regulation of Six-phase Rectifiers with Reactance in the Primaries of Supply Lines	176
XII. Special Regulation Problems and Compounding of Rectifiers.	198
XIII. Effect of Resistance on Wave Shapes, Interphase Transformer and Choke Exciting Currents.	214
INDEX.	227

PART I
MERCURY ARC AND
THERMIONIC RECTIFIERS

PRINCIPLES OF MERCURY ARC RECTIFIERS AND THEIR CIRCUITS

CHAPTER I

KENOTRON RECTIFIERS

Rectifiers.

A rectifier in the broadest sense is any device which presents a different resistance to the flow of current when the direction is reversed. To be of value, however, the conductivity in one direction must be quite good and the resistance to current flow in the other direction very high. Such a device will then act as an electrical check valve.

If a rectifier is conducting a steady direct current of any magnitude, it can also pass an alternating current of smaller magnitude; that is, a rectifier carrying a 10-ampere direct current may also pass a 2-ampere alternating current without distorting the latter in the least. This holds true until the total current suffers reversal, and then the rectifier will exercise its check-valve action.

Kenotron Rectifiers.

The kenotron is the most clean cut of rectifiers in its action, and its operation is readily understood. For this reason it will be considered first. It consists of a hot filament surrounded by an anode, the two being inclosed in an evacuated vessel. Conductivity is due to the electrons which are emitted by the filament in large numbers. These electrons are negative charges of electricity and, if the anode is made positive, they will be attracted to it. Their passage across the space between the cathode

(filament) and anode represents the flow of a current equal to the product of the number of electrons passing per second and the charge per electron. As the charge per electron is 1.591×10^{-19} coulombs, it will be seen that the number of electrons passing must be very great for even small currents. If the anode (often called the plate) is made

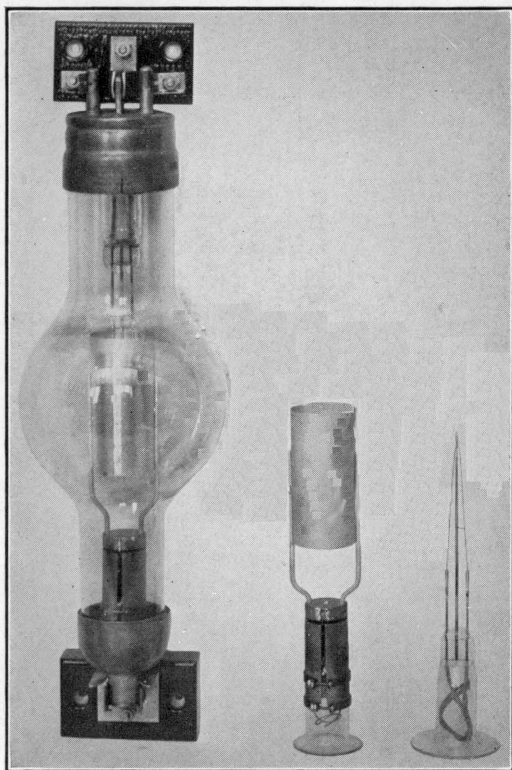

FIGURE 1.—Kenotron rectifier, anode and cathode.

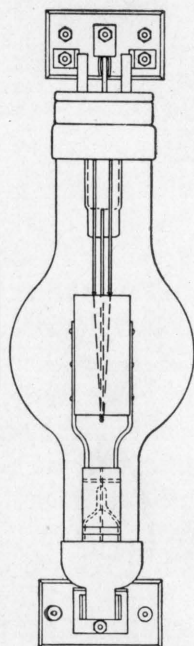

FIGURE 2.—Arrangement of parts in a kenotron.

negative with respect to the filament, the electrons will be repelled from the former and forced to reenter the cathode. As the plate emits no electrons, there can be no movement of charges in the reverse direction, and conductivity in this case does not exist. Figure 1 is a photograph of a kenotron and figure 2 illustrates the arrangement of the principal parts.

The Filament.

The filament may be made of pure tungsten or of an alloy or of platinum or nickel coated with certain salts. In

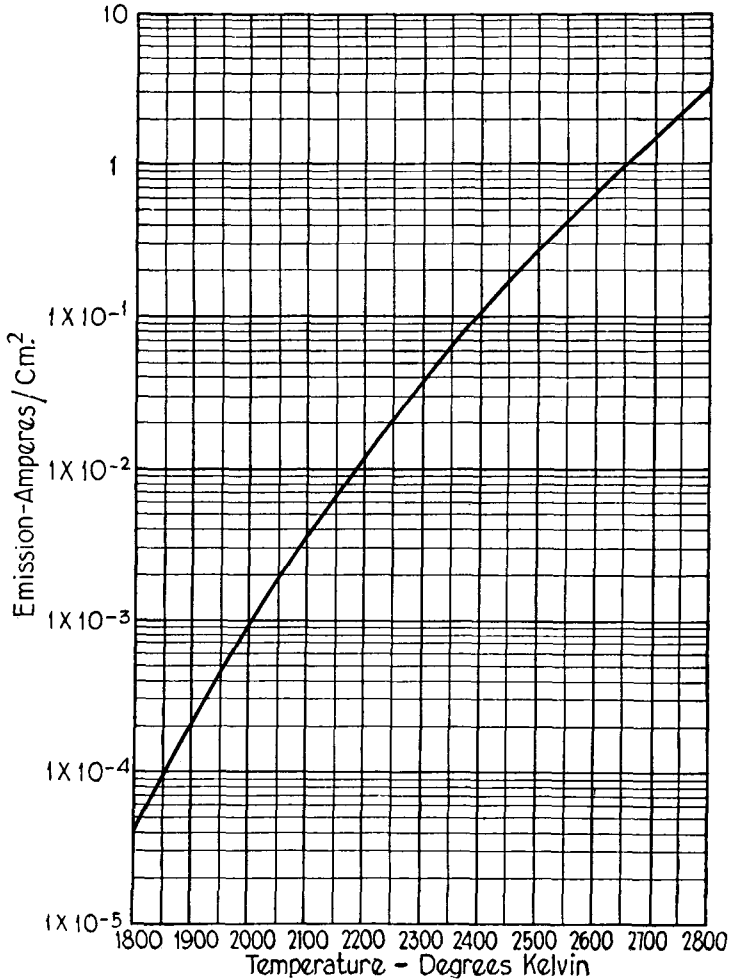

FIGURE 3.—Emission from tungsten as a function of temperature.

any case the fundamental principle is the same. Heating of the cathode adds to the kinetic energy of those electrons in the material which are free to move about until a point is reached when some of them have sufficient energy to escape through the surface of the electrode. Once they

have escaped, they may again strike the surface and be recaptured, or they may be drawn away by some positively charged body.

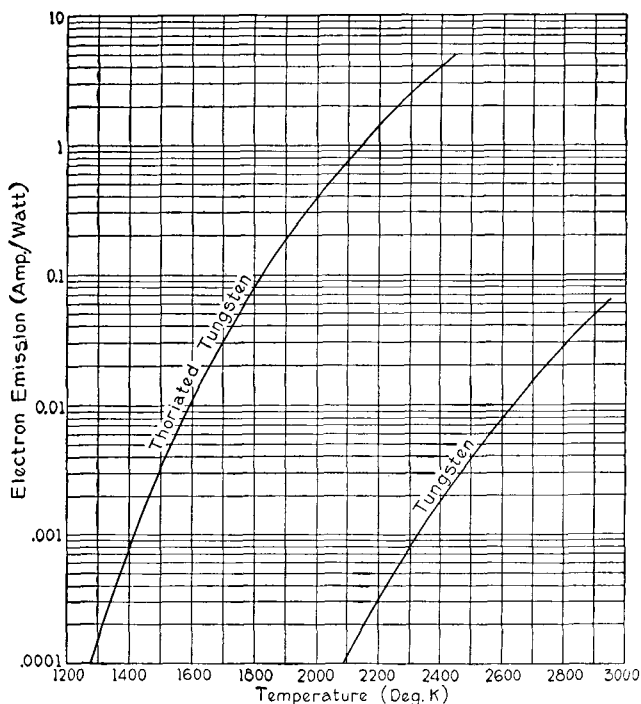

FIGURE 4.—Comparison of emissions obtained with pure tungsten and thoriated tungsten.

Emission.

For pure tungsten, the law of emission is expressed by the following equation which was derived from theoretical considerations:¹

$$I = AT^2 \epsilon^{\frac{-b_0}{T}} \quad (1)$$

where

I = current in amperes per square centimeter,

T = absolute temperature in degrees K.,

A = a constant = 60.2,

b_0 = a constant = 52,600.

¹ Form due to S. DUSHMAN, *Phys. Rev.*, vol. 21, No. 6, pp. 623-636, June, 1923. The original form of this equation was first given by O. W. RICHARDSON.

Figure 3, prepared from this equation, shows graphically the variation of emission with temperature.

Conditions at the surface of cathodes of tungsten containing thorium or of metal coated with certain salts are more favorable for the escape of electrons and, hence, they give much higher emission, as shown in figure 4.¹ Care must be taken with such filaments that they are not burned too brightly or their high emission will be lost.

Space Charge.

There is a limit to the number of electrons that can be drawn across a space by a particular potential difference regardless of the number which may be emitted. Once the electrons are free in the space, they represent a charge of negative electricity, and an electric field must exist between this charge and the electrodes of the tube. If any considerable part of this field went to the cathode, it would cause a negative potential gradient at its surface of sufficient magnitude to force back all the electrons emitted. The major portion of the field, then, must be located between the charge in the space and the anode. For a fixed anode potential there is, therefore, a limit to the number of electrons which can be in the space at any time without making it impossible for other electrons to enter from the filament region. As the electrons have mass, as well as charge they will be accelerated and pulled across the space at a definite rate. Hence, at a fixed voltage, the space current will consist of a definite number of electrons moving at a definite rate. In other words, the current is limited by the space charge.

It is apparent that the velocity with which the electrons start their passage between cathode and anode is capable of affecting the number which cross the space. The electrons are emitted with velocities enabling them to move short distances against negative electric fields before they are stopped. These velocities vary between wide limits,

¹ For original data, see S. DUSHMAN and JESSIE W. EWALD, *Gen. Elec. Rev.*, March, 1923.

but the average electron can move only through a negative potential difference of less than 1 volt.

Space-charge Law.

On the assumptions that more electrons are being emitted than are needed, that they are emitted at zero velocity, and that the cathode is an equipotential surface, the current

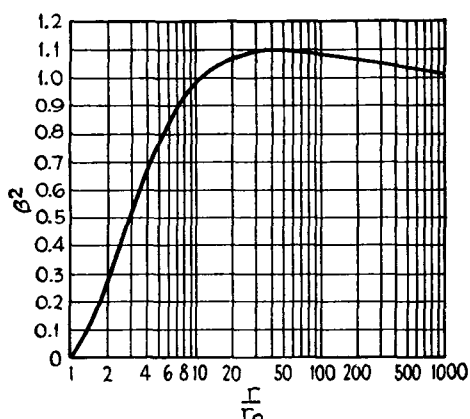

FIGURE 5.

drawn between a plane cathode and a parallel-plane anode is given by the theoretical equation:¹

$$i = 2.33 \times 10^{-6} \frac{V^{\frac{3}{2}}}{x^2} \quad (2)$$

where i = the current in amperes per square centimeter,

V = the potential difference between the electrodes in volts,

x = the distance between the electrodes in centimeters.

If the cathode and anode are concentric cylinders, the expression becomes

$$i = 14.65 \times 10^{-6} \frac{V^{\frac{3}{2}}}{r\beta^2} \quad (3)$$

¹ IRVING LANGMUIR, *Phys. Rev.*, N. S., vol. 2, pp. 450-486, December, 1913. See also C. D. CHILD, *Phys. Rev.*, vol. 32, p. 492, 1911.

where i = the current per centimeter of length,
 r = the radius of the anode in centimeters,
 V = the potential difference in volts,
 β^2 = a function of the ratio of anode and cathode radii.

The value of β^2 for different ratios of anode radius to cathode radius is shown in figure 5.¹ It is ordinarily

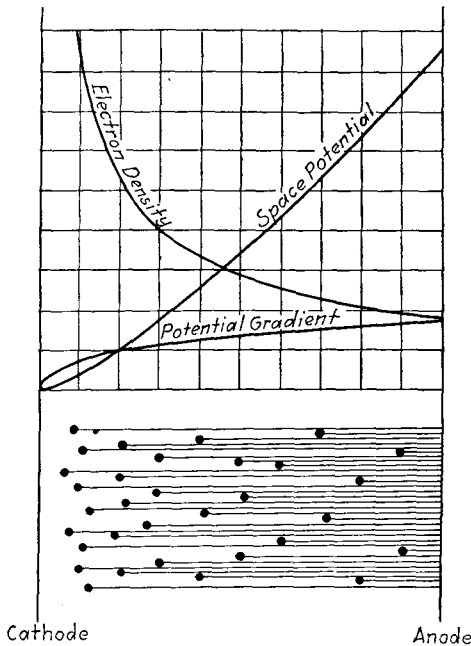

FIGURE 6.—Graphical representation of a space charge field between plane parallel electrodes.

considered to be unity for tubes of the usual proportions (anode radius greater than ten times cathode radius); the error involved appears to be offset by those involved in other approximations.

Figure 6 illustrates graphically the conditions prevailing in the space between the electrodes for the plane-parallel case.

¹ IRVING LANGMUIR, and KATHARINE B. BLODGETT, *Phys. Rev.*, vol. 22, No. 4, pp. 347-356, October, 1923.

Special Considerations.

Several errors are usually involved in the application of equations (2) and (3) to an actual tube. First, there will be a small error due to irregularities at the ends of the electrodes. Second, the emission velocities of the electrons will not be zero as assumed. The error involved in this assumption has been carefully investigated and found to be

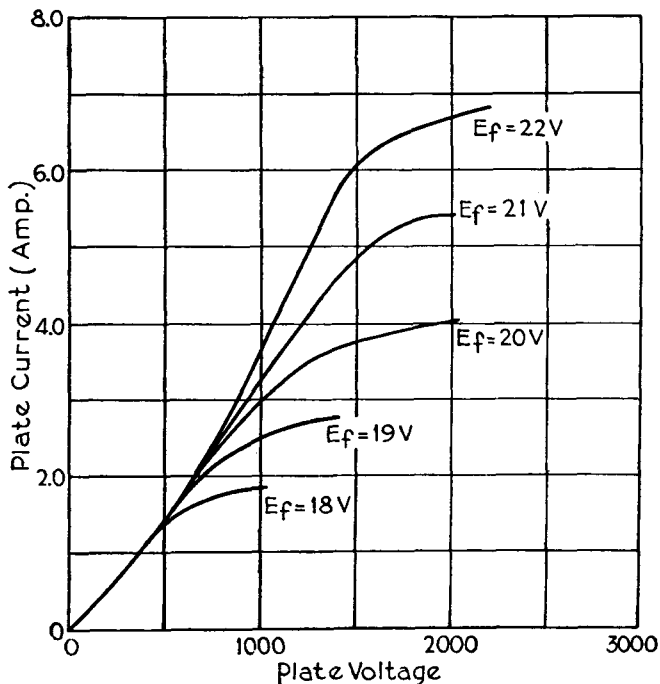

FIGURE 7.—Characteristics of a kenotron.

of small magnitude in the usual case.¹ A third error which is of importance occurs when the filament heating power requires a voltage comparable with that applied between the electrodes. This results in the potential between anode and cathode varying for different sections of the tube. In the extreme case, part of the tube does not conduct current at all, due to the fact that the potential is in the wrong direction. In this case, the active portion

¹ IRVING LANGMUIR, *Phys. Rev.*, vol. 21, No. 4, pp. 419-435, April, 1923.

of the tube increases with the plate potential, and the current may be represented as the five-halves power of the voltage instead of the three-halves.

Complete Characteristics.

By combining the emission equation (1) and the space charge equation (2) or (3), there results the complete characteristics of a kenotron as shown in figure 7. As the potential difference between anode and cathode increases, the current increases according to the three-halves-power law until it approaches the total emission. It then flattens out as shown, and the tube is "saturated" for that particular value of filament heating energy. All of the theoretical emission is never available, as the filament is cooled locally by the supports and in a filament folded on itself (as in a V or W shape), the inner surfaces of the wire are screened more or less by the other wires so that the electrons are not drawn away freely. It should be noted, however, that the filament temperature may be increased by radiation received from the anode, and this will result in an increase in the theoretical emission.

Space-charge Loss.

The work done on each electron as it is pulled across the space by the electric field results in accelerating it. Each electron arriving at the plate has a kinetic energy equal to the product of its charge and the potential difference through which it has passed. Arriving at the anode, the movement of the electrons is arrested and their kinetic energy is converted into heat. This represents power to be dissipated by the anode of a kenotron equal to the product of current and voltage drop across it. The electrons are individually so light that their constant impact does not ordinarily produce any erosion of the anode material, but if their velocity is great enough (corresponding to voltages of the order of 30 kilovolts), appreciable emission of x -rays is produced and soft metals such as copper may be worn away.

Filament Loss.

The power lost in heating a pure-tungsten filament may be obtained from figure 8¹ which gives the temperature, emission, and other factors for a 10-mil wire with the con-

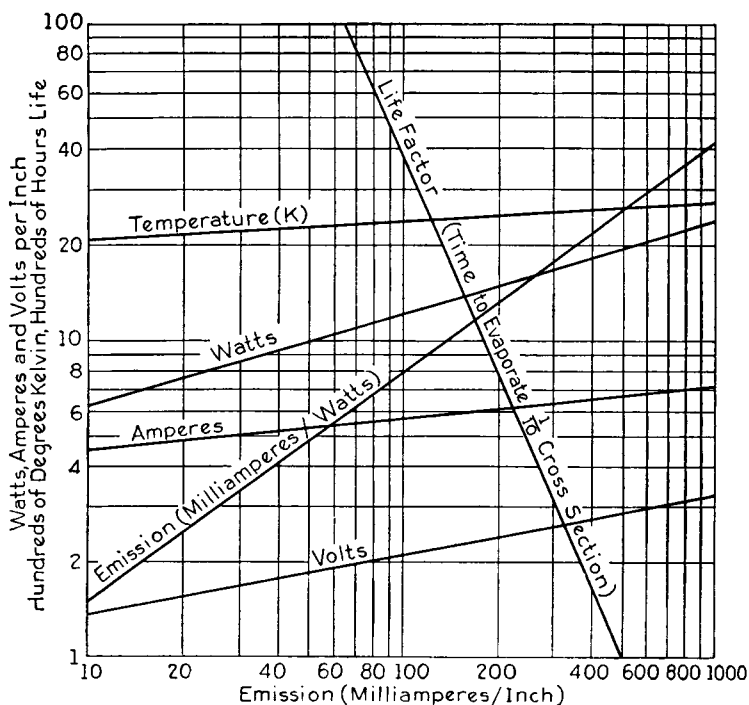

FIGURE 8.—Heating energy for 10-mil tungsten filaments. For filaments of diameter d , holding temperature constant:

$$\text{Emission}_d = \text{Emission}_{10} \times \frac{d}{10}$$

$$\text{Watts}_d = \text{Watts}_{10} \times \frac{d}{10}$$

$$\text{Filament ampere}_d = \text{Filament ampere}_{10} \times \left(\frac{d}{10}\right)^{\frac{3}{2}}$$

$$\text{Life}_d = \text{Life}_{10} \times \frac{d}{10}$$

$$\text{Filament volts}_d = \text{Filament volts}_{10} \times \left(\frac{d}{10}\right)^{-\frac{1}{2}}$$

version factors for other sizes. Since the filament is usually inside the anode, the loss occurring in it will have to be radiated by the anode in addition to the space-charge loss.

¹ For original data, see LANGMUIR, "The Characteristics of Tungsten Filaments as Functions of Temperature," *Gen. Elec. Rev.*, March, 1916.

Field of Usefulness of Kenotron Rectifiers.

Consideration of figure 7 indicates the field in which kenotron rectifiers are most useful. The tube of which the characteristics are shown requires a filament excitation of 52 amperes at 22 volts. The resulting emission is large enough so that 6 amperes can be passed through the tube, and the resulting space-charge drop is 1470 volts. In the usual polyphase rectifier circuit, each tube carries full current for one-third of the time. Hence, in a group of three tubes, there would be a loss of 3.43 kilowatts for filament excitation and 8.83 kilowatts for space charge, or a total of 12.26 kilowatts. This corresponds to the loss which 6 amperes would cause in flowing through a resistance large enough to give a drop of 2043 volts. Using this simple scheme to visualize efficiency, it is apparent that the kenotron does not become comparable in efficiency to a high-power transformer (98 per cent efficiency) until the voltage reaches the order of 100 kilovolts. Since the filament excitation represents only about one-third of the total loss, no improvement in emission efficiency will greatly relieve this condition.

The particular usefulness of the kenotron appears at high voltages and it holds considerable promise in this field. Should it become desirable to transmit power over long distance by high-voltage direct current, it is very probable that the required rectifiers could be constructed. X-ray tubes have been built which operate at over 200 kilovolts. To build kenotrons for similar voltages would require a great deal of attention in arranging the parts so that the necessary very high vacuum could be obtained and, also, in seeing that the unavoidable residual gases would not constitute a menace to the life of the tube. There appear to be no well-defined limitations to progress in making kenotrons for either higher voltage or currents. So far kenotrons have not been made exceeding greatly the current-carrying capacity indicated in figure 7, while a direct voltage of 50 kilovolts has been reached in rectifiers of considerably smaller current-carrying capacity.

Due to the small mass of the electrons which the kenotron uses for the conduction of current, these tubes are very rapid in their action, and clean-cut rectification of radio frequencies is readily obtainable with them. They are also very useful when only a small amount of power is required because of the simplicity of their construction and operation. Hence, it is not strange that they are widely used in radio work and in many laboratory experiments. For power work, however, the best applications are the cases in which the voltage is quite high. For low-voltage work in which more than a few watts are required, they are found to be less suitable.

CHAPTER II

TUNGAR RECTIFIERS

Properties Required of Rectifiers for Power Work.

For low potentials, a rectifier must have a low voltage drop while conducting current, if it is to compete with other direct-current apparatus. The ability to respond at high frequencies is not necessary, for the current changes through the ordinary power rectifier are very sluggish when compared with radio-frequency phenomena. The field for low-voltage rectifiers is quite large, but the cost of any such device must be low, for other comparatively inexpensive apparatus is available for this work.

Tungar Rectifier.

The tungar rectifier is well fitted for the purpose for which it is intended. In simplicity, freedom from moving parts, and efficiency it compares very favorably with other means of obtaining a direct voltage for charging storage batteries singly or in small groups.

By adding argon gas to a tube similar to a kenotron, the space-charge drop is greatly reduced. In doing this, however, the ability to hold back high voltages in the reverse direction is diminished.

Figure 9 is a photograph of a tungar bulb. Figure 10 shows a small tungar battery charger. The tungar anode is of graphite, and the cathode is of tungsten. The bulb

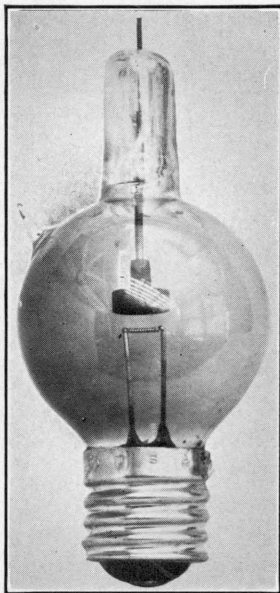

FIGURE 9.—Tungar bulb.

is filled with argon gas, which has a pressure of about 5 centimeters of mercury when it is cold. When the parts are assembled in the bulb, a ring of magnesium wire is placed around the anode. After the air has been pumped out and the argon admitted, the tube is sealed off the pumping system, and the anode is heated. This vaporizes the magnesium, and it combines with any traces of air or water vapor which may have been left in the bulb. The

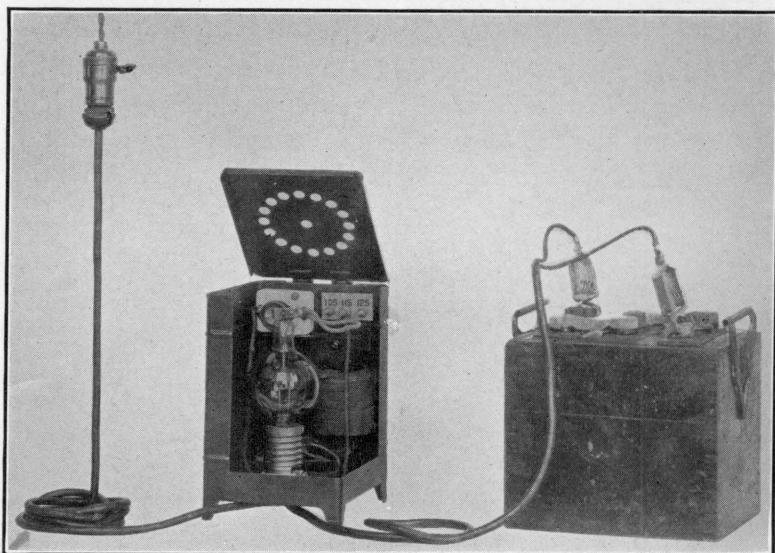

FIGURE 10.—Tungar battery charger.

resulting compounds and all the extra magnesium are condensed on the surface of the bulb where they are no longer able to influence the electrical behavior of the rectifier, although the magnesium continues to absorb gases and other impurities throughout the life of the tube. The magnesium gives to the glass the dark mirror-like appearance which is so characteristic of tungar bulbs.

Ionization of Argon.

The argon gas reduces the voltage drop in the tungar rectifier by providing positive ions to neutralize the space

charge of the electrons. Electrons leaving the filament are accelerated by the electric field. If they collide with an argon atom¹ immediately after leaving the filament, there will be no other result than a change in the motions of the two bodies. If, however, the electrons are allowed to acquire a certain velocity before making a collision, they are able to break the atoms which they strike into two parts, an electron and a positively charged argon ion.

The atom, before ionization, consists of a positively charged nucleus surrounded by electrons moving in orbits about it. The nucleus consists of positive charges (protons) and electrons. The proton charge is equal and opposite to that of the electron, and there are more protons than electrons in the nucleus with the result that the total charge is positive. The nucleus is very firmly knit together. Apparently it is impossible for it to change without changing the chemical element which it represents. The electrons outside the nucleus, however, are not so firmly bound, and it is possible to remove one or more of them.

The process of ionization, then, consists of the removal of an electron from an otherwise neutral atom. The nature of the impact of the external electron with the neutral atom is not completely understood, but it is believed that the electron passes very close to the atom and is able to disturb the orbit of the outermost electron in the latter so that the electric field of the positive nucleus is no longer able to hold it.

Recombination of Ions and Electrons.

Ions and electrons may recombine to form neutral atoms. As the electrons enter the atoms and settle down to motion in the fixed orbits, they radiate light which may be either visible or outside the visible range. The complete adjustment takes place in a series of minor movements, and each transition results in the radiation of light of a frequency peculiar to it. This light is the glow observed in tungar bulbs in operation, and it does not mean that the gas is at a high temperature.

¹ Argon is a monatomic gas.

The process of ionization may be helped by this radiation; that is, the energy derived by electrons settling into the more stable orbits of some atoms may be absorbed by other atoms and cause their electrons to move into orbits from which they are more easily displaced.

Movement of the Electrons and Positive Ions.

The movement of the electrons and positive ions consists of random motions in all directions, due to the frequent collisions, plus general motions due to the electric field. The explanation of conduction depends on both these motions, which can be deduced from the potential distribution between the cathode and anode. This has been measured¹ and is of an unusual form. Starting from the cathode which is assumed to be at zero potential, the voltage increases very rapidly until a value is attained about half again as high as that on the anode (which is about 8 to 10 volts). From this point it decreases until the anode is reached. The space may, therefore, be considered as though divided into two sections, a thin sheath around the cathode and the major portion of the space including all the range between the anode and cathode with the exception of this sheath.

At the outer boundary of the cathode sheath, there will obviously be a marked change in the conditions of the ionized gas. Inside the sheath no positive ions can be formed because the electrons from the filament have not had a chance to obtain sufficient velocity to make ionizing collisions. When the outer surface of the sheath is reached, the electrons will have sufficient velocity to ionize any atom which they may happen to strike in the proper manner. Due to the high density of the atoms, they will not have far to travel before they strike one and lose their own velocity in the process of ionization. This leaves them with only a moderate velocity with the potential gradient in either direction hindering their travel. Conditions, there-

¹ K. T. COMPTON and CARL ECKART, "The Diffusion of Electrons against an Electric Field in the Non-oscillatory Low-voltage Arc," *Phys. Rev.*, vol. 25, No. 2, pp. 139-146, February, 1925.

fore, do not favor the acquisition of sufficient velocity to enable them to make further ionizing collisions. Hence, very little ionization will take place except at the outer boundary of the cathode sheath. The number of positive ions and additional electrons formed at this point is quite large, and this is necessary for the maintenance of the arc because many are lost in recombination.

Some of the positive ions formed are attracted to the cathode. There is a limit to the number which can move in this direction, however, for they are so heavy that the electric field cannot accelerate them rapidly, and they form a positive-ion space charge about the cathode similar to the electron space charge in the kenotron. The electrons emitted from the cathode are drawn through this field in the opposite direction and tend to neutralize it. The number of them passing is high but their mass is so small that they are drawn through very quickly. The result is that the number in the space-charge zone at any time is small compared with the number of positive ions, and the field will be due in large part to the latter.

In the major portion of the space, the electrons and positive ions are so arranged that their densities at any point are nearly equal. The slight inequality causes the potential gradient which is in the direction to repel electrons from the anode and attract positive ions. Such motions, however, would be in the wrong direction, and some other force must also be acting to give a motion to the electrons in the direction actually obtained. This is the mechanical force due to the concentration gradient of the electrons which are formed in such large numbers at the outer edge of the sheath surrounding the cathode. Starting from this point, they diffuse toward the anode against the electric field and recombine with positive ions as they go, so that only sufficient electrons reach the anode to correspond to the current being conducted.

It will be seen that conduction throughout the entire path is largely dependent on the motion of the electrons. Movement of the positive ions represents a small current,

but this is almost negligible in comparison with the electron currents, for the latter move much more rapidly under the same conditions and are present in somewhat comparable numbers. The real value of the positive ions, therefore, is in neutralizing the space charge which would be encountered if only electrons were present.

When the current is quite small, there may be insufficient ions to neutralize the negative space charge. As the current is increased, a glow suddenly appears and the drop then falls to the value characteristic of normal operation.

The Filament.

At the filament surface, the current consists of the positive ions entering and the electrons leaving it. As the latter component represents by far the greater portion of the current, it is apparent that the filament emission is of considerable importance. There may be an increase in emission due to the presence of the positive-ion space charge and bombardment of the filament by the positive ions other than that due to the resulting increase in temperature, though the amount of such additional emission is probably small. On the other hand, the high gradient of the positive-ion space charge is available when required so that all the emission can be used and that no electrons will have to return to the filament because of a lack of an electric field to move them away. All this emission, of course, need not be used if it is not required by the external circuit. The emission easily obtainable from the filament is, then, at least equal to the value corresponding to its temperature, and the latter is increased somewhat by the bombardment by the positive ions.

The bombardment of the filament by the positive ions has another effect upon it. The material of the filament is slowly worn away. Some spot will usually suffer more erosion than the remainder of the filament and will become hotter, thus concentrating more load upon itself until it finally burns out. This is the factor determining the life of such rectifiers.

Performance of Rectifier Units.

The arc-drop in a tungar rectifier is about 10 volts, and the filament of a 5-ampere tube requires about 40 watts. The equivalent of the latter loss may be obtained by assuming the load current of 5 amperes to flow through a resistance giving a voltage drop of 8 volts. The other losses are those of the transformer and are of no great magnitude. Neglecting the transformer losses and assuming the tungar to be charging a 6-volt storage battery, its efficiency will be $\left(\frac{6 \text{ volts}}{6 \text{ volts} + 10 \text{ volts} + 8 \text{ volts}}\right)$, or 25 per cent, a very fair efficiency when compared with that obtained with other methods of accomplishing the same result. If the battery were charged from a 110-volt, direct-current lighting circuit, using a resistance to limit the current, the operation would be very simple, but the efficiency would be less than 6 per cent. If a motor-generator set were used, the no-load losses would be considerable, and while better efficiency than that of the tungar might be obtained, the operation would not be as simple and convenient. If the tungar is supplied with a load of higher voltage, its efficiency is much increased, 50 per cent efficiency being obtained in cases which are far from the most favorable.

Limitation on Operating Voltage.

It has been shown how the normal conduction of current through the tungar rectifier depends upon the emission of electrons from the filament. Conductivity in the reverse direction cannot occur by a similar mechanism, for the anode is not normally a source of electrons. If too high a voltage is applied to the tungar, however, conductivity in the reverse direction takes place by means of a different mechanism not well understood. One explanation, which has the advantage of simplicity although not entirely acceptable, states that the anode becomes a source of electrons due to the bombardment of it by positive ions; that is, the space between the electrodes is left full of ionized gas when conductivity in the normal direction ceases and the

positive ions are drawn over toward the anode by the reversed electric field and strike it with sufficient force to cause it to emit the electrons necessary for conduction of current. Regardless of the mechanism, however, there is a limit to the voltage at which tungar rectifiers will operate satisfactorily, and in their present state of development, completely satisfactory operation cannot be obtained above a few hundred volts.

CHAPTER III

CONSTRUCTION OF MERCURY ARC RECTIFIERS

The mercury arc rectifier finds its greatest usefulness in a field lying between those of the tungar and kenotron. The positive ions of the mercury vapor neutralize the space-charge effect of the electrons so that a low voltage drop is obtained although not quite so low as that of the tungar. The inverse voltage which can be held back is much higher and the current-carrying capacity is very large so that rectifiers can be constructed having a capacity of hundreds of kilowatts.

For small capacities within the tungar range, the cost of automatic starting equipment for the mercury rectifier usually swings the choice to the tungar. For low voltages (100 volts and less) combined with larger currents (over 15 amperes), the losses in a mercury arc rectifier are high enough so that motor generators may have higher full-load efficiencies, but at light loads the small stand-by losses of the rectifier may give it an advantage even here. Rectifier losses are practically the same at any voltage, and above 600 volts it is difficult to find any device giving greater efficiency and economy.

The upper limit of the voltage which can be carried by mercury arc rectifiers has not yet been definitely indicated. Rectifiers having an output voltage of 4000 or 5000 volts are readily constructed in small sizes for special applications, but just how high a potential will be found as the desirable limit for large units is not yet known.

The Cathode Spot as a Source of Electrons.

The most striking feature of the mercury arc rectifier is the manner in which the electrons are obtained from the cathode. The latter consists of a pool of mercury, and the

source of electrons is a bright spot which moves about on its surface. The passage of the arc current itself maintains this spot, and there appears to be no limit to the number of electrons which can be obtained by this means. For very high currents several spots may carry the current.

Before the formation of the cathode spot, the rectifier will not conduct current in either direction, and if the cathode current is interrupted, the spot must be started again. This is accomplished by means of an auxiliary anode which can be brought into contact with the cathode and then removed. By breaking a current passing between the two electrodes, a small arc is started and the cathode spot established. For small rectifiers the auxiliary anode usually consists of a small pool of mercury or an extra anode at the side of the cathode which can be connected with the cathode by tilting the tube. In large rectifiers the starting anode is made movable.

In order to insure that some current is always passing to keep the cathode spot in existence, it is necessary to have more than one anode in a tube and so arrange the circuit that at least one is always carrying current.

The mercury arc rectifier differs in principle, then, from other rectifiers in two respects: first, in the use of the cathode spot on the mercury and, second, in the use of a number of anodes in one vessel. Other variations are only the result of changing the details to get the best mechanical construction and electrical performance.

No Interference between Anodes.

It is fortunate that the anodes of a mercury arc rectifier do not interfere with each other. Kenotrons can be made with only one anode. If more were present, the electric fields due to those which were idle at any instant would tend to drive the electrons back to the filament and thereby greatly increase the potential necessary to cause electrons to pass to those anodes which were carrying current. In the mercury arc rectifier this effect does not exist, for a space charge of positive ions builds up around a negative

electrode, and its field can extend only a very short distance. Charges which may appear on the glass are neutralized in a similar manner.

Bombardment of the negative electrodes by the positive ions is not desirable because of the energy loss involved and the gradual disintegration of the anode material. This is not a bar to the use of a number of anodes in a single vessel, however, for the bombardment can be greatly decreased by placing the anodes in arms extending from the main chamber, and for higher voltages these arms may have bends in them. The arms then act as electric shields even though they are of glass, while the distance which the positive ions must travel is greatly increased and the number collected is therefore quite small.

Development of the Mercury Arc Rectifier.

The apparently unique construction of the mercury arc rectifier is the natural result of the manner in which it was developed. The first use of mercury vapor to conduct current in an apparatus at all resembling the present-day rectifiers was by Peter Cooper-Hewitt, who invented the mercury vapor lamp shortly before the opening of this century. It was soon discovered that these lamps had the properties of rectifiers, and this led to the development of the glass mercury arc rectifier in its present form. The methods used in manufacturing the glassware for the lamps permitted bulbs of various shapes to be constructed rapidly and cheaply, and these bulbs were found to be quite satisfactory inasmuch as they can be sealed so tightly that no gas can leak through them. Figure 11¹ shows part of the collection of rectifiers built by Dr. Steinmetz between 1903 and 1905 when he was investigating the effects of various tube shapes upon the operating characteristics.

At the end of this period the rectifiers had reached nearly their present form. Figure 12 shows a 4-ampere mercury arc rectifier for series street-lighting circuits which might

¹ Taken shortly after Dr. Steinmetz's death.

almost have been picked from the collection made 20 years ago.

Figure 13 shows a modern 50-ampere glass rectifier which is similar in form to the rectifiers produced for battery charging since 1910. Recently, however, the

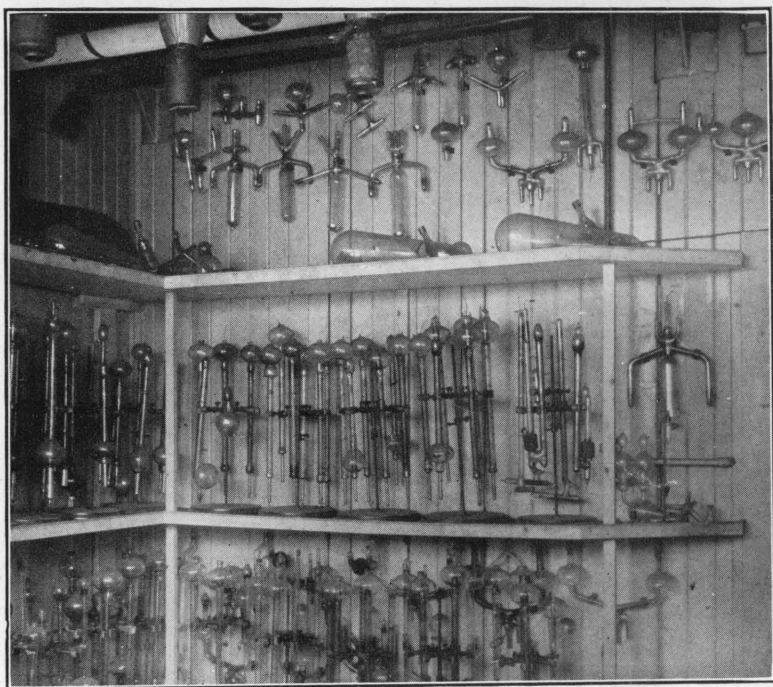

FIGURE 11.—Some early mercury arc rectifiers.

auxiliary anodes have been added to maintain the cathode spot and permit holding the tube ready for service regardless of load or wave forms in the main circuit. Several other improvements in construction have also been made.

Seals for Glass Rectifier Bulbs.

One of the most important problems in the manufacture of glass rectifiers is in obtaining a lead for the electrodes which can be sealed through the glass and be absolutely vacuum tight.

The early tubes employed platinum wire and lead glass, but the platinum was replaced by dumet wire when this was developed for use in incandescent lamps. This wire is made up of a nickel-steel core coated with copper. In small sizes it seals readily through glass, but with large sizes the stresses due to changes in temperature cause the

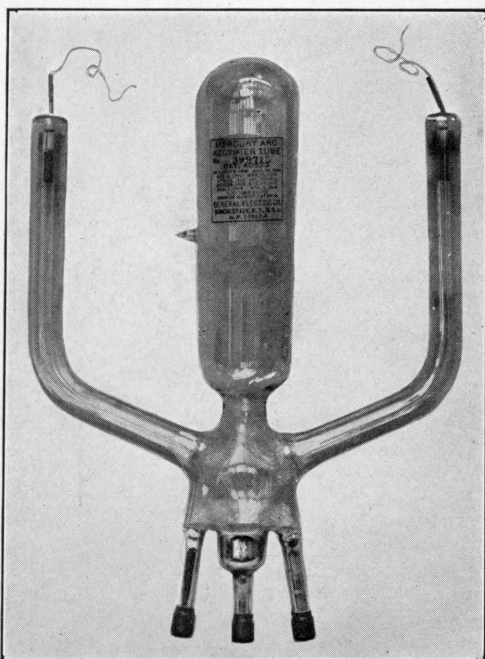

FIGURE 12.—Series mercury arc rectifier tube, 4 amperes.

seals to crack. For a 50-ampere tube, three small wires used in parallel seem to be about the limit.

In this country, but more successfully in Germany, glass has been developed having a coefficient of expansion suitable for sealing with molybdenum. In this case the agreement is good enough so that 5-millimeter rods of molybdenum can be used, and with this combination Schott, the famous glass manufacturer in Jena, has made for the A.E.G. (Allgemeine Elektrizitäts-Gesellschaft)

six-phase glass rectifiers having capacities up to 250 amperes and higher.

Recent work in this country, however, has apparently removed the seal limitation completely, at least for the present. In this case the conductor used is an alloy of

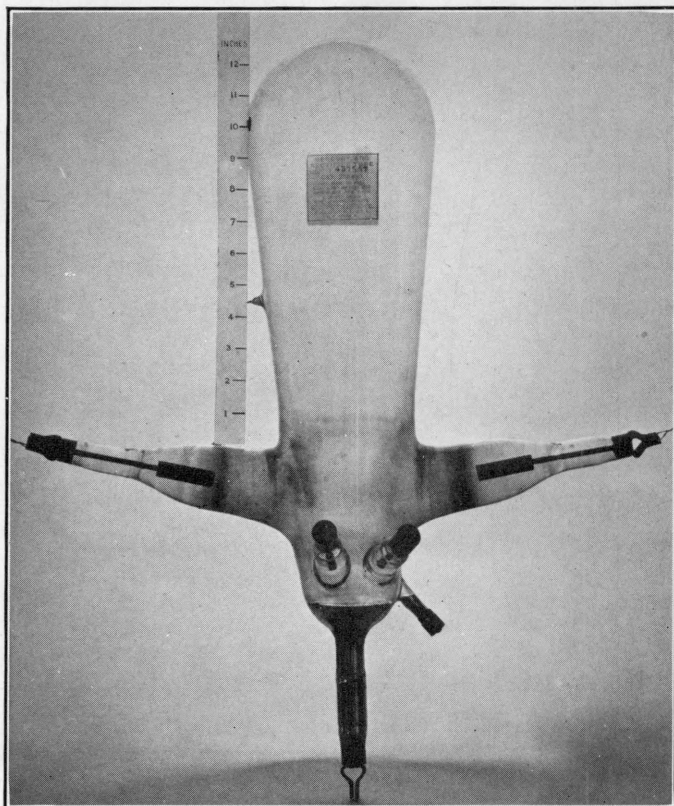

FIGURE 13.—Low-voltage mercury arc tube, 50 amperes.

iron and chromium, and single seals of this material have carried over 2000 amperes without any indication that the limit was approached.

Figure 14 is a photograph of a 250-ampere, three-phase glass rectifier, made by the General Electric Company, using these seals.

Development of the Iron-tank Rectifier.

Early in the development of the mercury arc rectifier it was seen to be a device capable of transforming power in large quantities. It was apparent, however, that the containing vessel of large rectifiers could not be made of

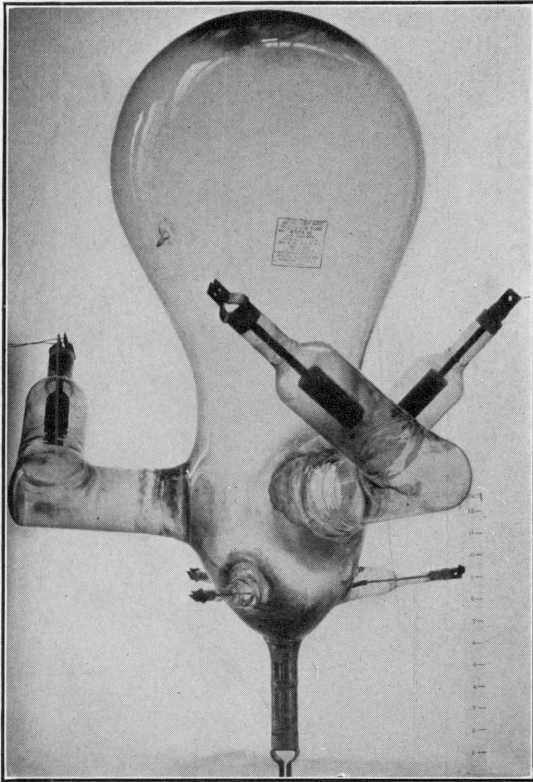

FIGURE 14.—Glass rectifier, 250 amperes.

glass, so attempts were made to build an iron-tank rectifier as early as 1905. Figure 15 shows one of these rectifiers in which the form of the glass rectifiers was closely copied in iron, and water jackets were used to aid in condensing the mercury vapor. These water jackets are a valuable feature of iron-tank rectifiers for the losses in the rectifier increase with the current carried and, if the temperature

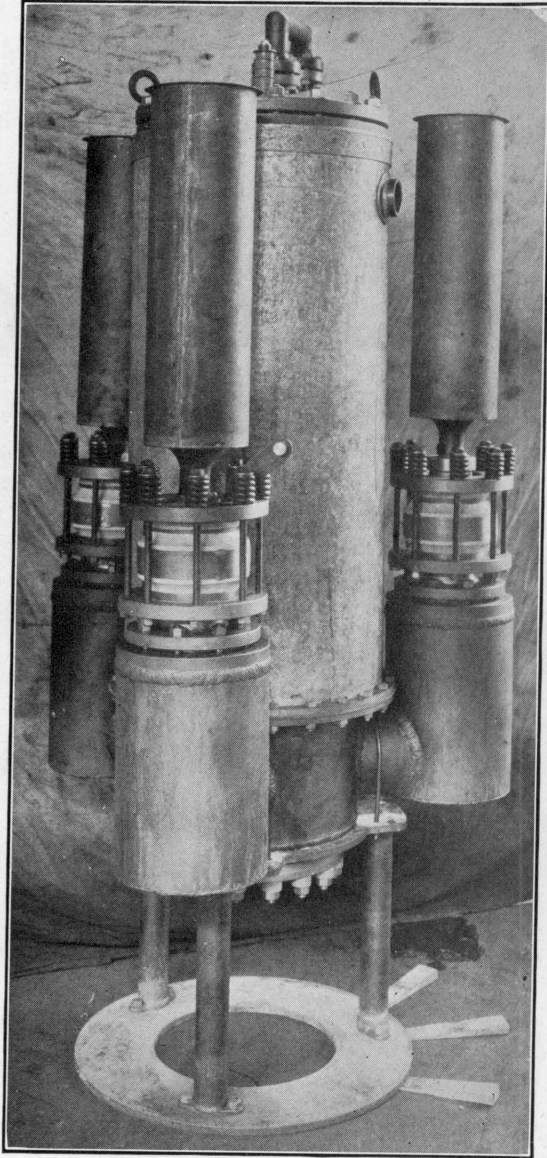

FIGURE 15.—Early iron-tank rectifier.

is allowed to rise too high, the mercury vapor pressure will increase beyond the value giving satisfactory operation.

The most serious difficulties encountered in building iron-tank rectifiers have been in connection with the insulators which must at the same time withstand both the electrical and mechanical stresses and maintain a high degree of vacuum. Innumerable schemes have been tried. Those most used have been based on two theories, either

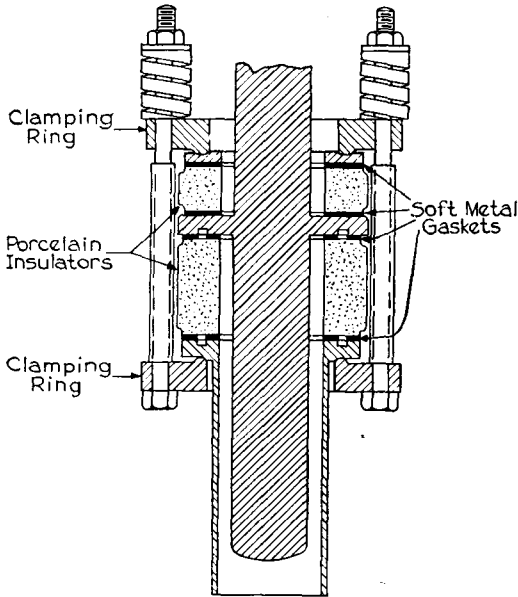

FIGURE 16.—Porcelain anode seal.

of which may be seen by referring to figure 16 which shows a porcelain anode seal. The anode stem carries a flange which is held between two porcelain rings. The lower porcelain which is the true insulator rests on a flange which is bolted or welded to the tank assembly. The function of the upper porcelain is to insulate the clamping system from the anode lead. This clamping system consists of two rings drawn together by bolts and heavy spring washers. It holds the anode stem, insulator, and tank flange firmly together. Gaskets of soft metal placed on

either side of the porcelain insulators aid in obtaining a tight joint with uniform pressure on the porcelain, and the springs allow the parts to expand and contract at different rates without loosening.

At first it was attempted to maintain a high enough vacuum with no other provisions than those mentioned, that is, gaskets under pressure. But porcelain has a very low rate of expansion while iron changes size relatively rapidly as it is heated. This causes almost constant rela-

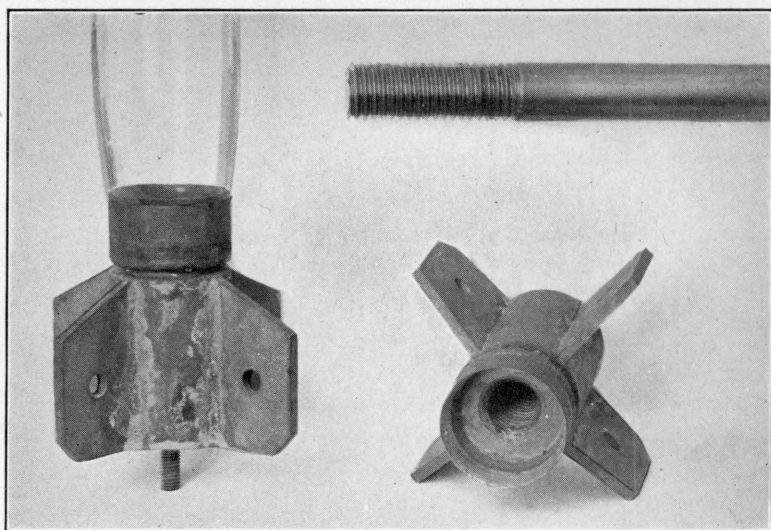

FIGURE 17.—Chrome-iron seals.

tive motion of the porcelain and iron, thus permitting leakage.

One method of reducing this leakage is to provide grooves in the surfaces which comprise the seals and maintain a vacuum in these grooves. Leakage then occurs from the outside to the groove from which it is exhausted, and the pressure difference across the inner seal is too small to cause any considerable flow of gas.

In the second type of porcelain seal the grooves are filled with mercury so that any leakage will be mercury and not air. Neither method is perfect; so it is necessary to have

pumps operating at least occasionally to remove the gases which reach the inside of the rectifier.

Numerous attempts have been made to secure insulating vacuum-tight seals which do not involve the bolting together of materials of unequal coefficients of expansion. In figure 17 is shown a construction embodying on a large scale a type of seal used in *x*-ray tubes. The glass is sealed to the alloy of iron and chromium, already referred to in connection with the glass tubes, which has a coefficient of expansion so nearly equal to that of the glass used that the strains caused by the heating and cooling of the seal are quite small. Seals of this type are perfectly tight, but are not so strong mechanically as the clamped types.

Insulation of Cathode.

Not only must the anodes be insulated from the iron tank, but the cathode also must be insulated. There is no tendency for the cathode spot to form on a clean iron surface, but after operating a short time there are drops of mercury clinging to the condensing surfaces, and cathode spots may form on these drops if the tank and cathode are at the same potential. If the true cathode is grounded to the tank, the temporary cathode may take all the current which can then pass to the mercury pool by conduction so that the spot on the latter will be extinguished. After a short interval the drop of mercury is completely vaporized, and the parasitic spot is either extinguished or else attacks the iron in case there is a high voltage induced preventing complete rupture of the circuit. If the spot attacks the iron, it is certain to liberate large quantities of gas and may even burn a hole through the tank.

Difference in Arrangement of Iron and Glass Rectifiers.

The first iron-tank rectifiers followed closely the general form of the glass tubes. The latter material is a poor conductor of heat, however, and this necessitates the use of a large condensing dome on glass rectifiers in order to condense the mercury vapor without allowing the tem-

perature to rise too high. This was soon eliminated from the iron-tank rectifiers, and the anodes have also been placed in the condensing chamber with baffles to shield them from the mercury blast instead of placing them in separate arms, which is the easier construction when glass is used.

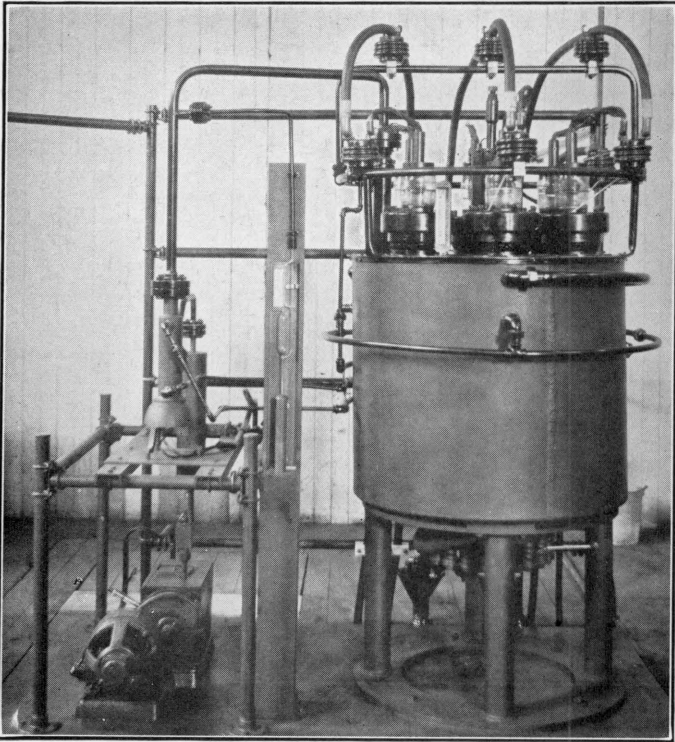

FIGURE 18.—Modern iron-tank rectifier.

Figure 18 shows a modern iron-tank rectifier. The vacuum pumps and gage are shown at the left. Figure 19 shows a section through this rectifier and illustrates the construction just described. The different concerns manufacturing iron-tank rectifiers build their rectifiers along lines which may depart from this in the details of construction, but are alike in general arrangement.

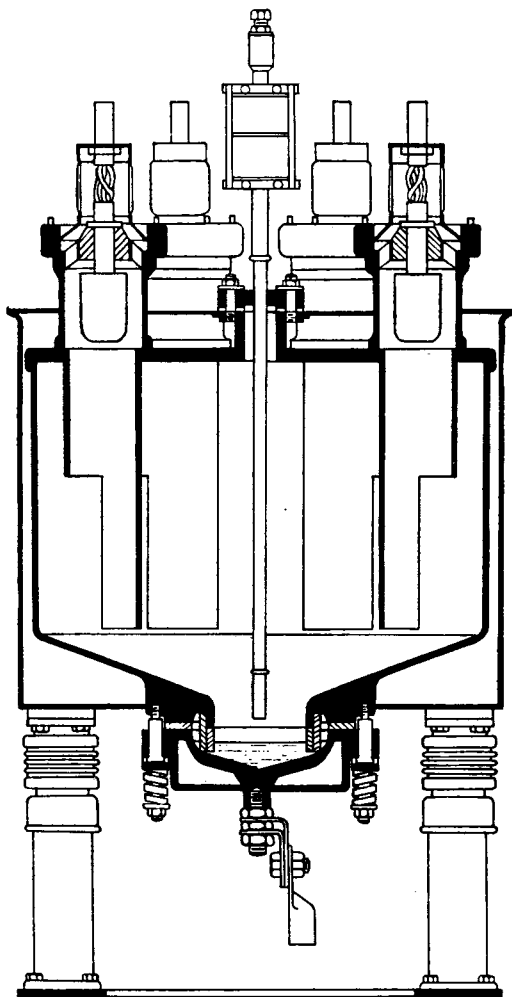

FIGURE 19.—Section through the rectifier shown in figure 18.

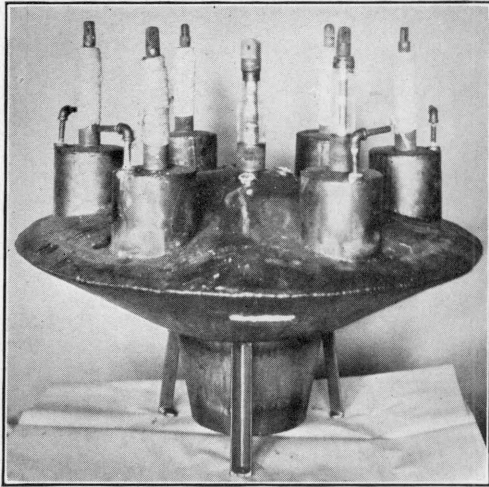

FIGURE 20.—Small iron-tank rectifier with no clamped joints.

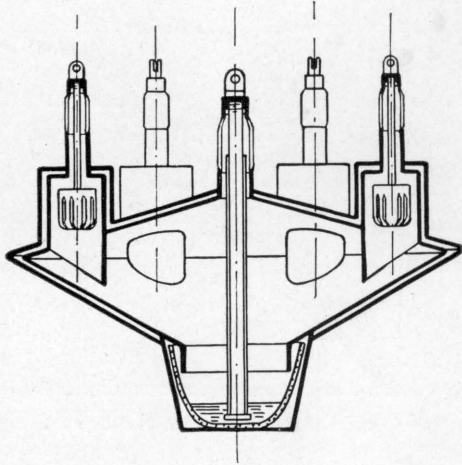

FIGURE 21.—Section through rectifier shown in figure 20.

Metal Rectifiers without Clamped Joints.

At present a type of rectifier is being developed which represents a compromise between the glass and iron types. Figures 20 and 21 show such a rectifier in which the materials of the iron tank and anode leads are so made that they can be sealed together by pieces of glass tubing which act as the insulators. Such seals are absolutely tight, and by proper treatment the tank itself can be made leakproof. Rectifiers of this type can be exhausted and sealed off in the manner used with glass tubes and, therefore, need not have a pumping system attached to them while in operation.

CHAPTER IV

THEORY OF MERCURY ARC RECTIFIERS

Although a great deal of work has been done upon it, the physical side of the operation of mercury arc rectifiers is not yet fully understood. Some points are pretty definitely established but of other phenomena all that can be said is that a variety of false hypotheses have been disposed of while those remaining are consistent with observation. This chapter, therefore, will be more of a starting point in a search for the truth than a description of theories which can be proved to be correct.

Mechanism of the Cathode Spot.

Conductivity has been seen to be dependent upon the formation of the cathode spot on the mercury, and from the nature of the conduction process the current can be carried in only one direction. If cathode spots existed on the other electrodes also, conductivity could occur in either direction, but such spots do not exist under normal operating conditions and this gives the device the properties of a rectifier.

The emission of electrons from the cathode spot appears to depend on several things. As it is negative it is continuously bombarded by positive ions. Also, the losses in the spot increase the temperature of the mercury surface where the spot may happen to be, thus aiding emission by thermionic means. Dr. Langmuir¹ has suggested a theory of the cathode spot, however, in which these two effects are only minor contributing factors. Under this theory the positive ions attracted to the cathode are so numerous that the resulting space-charge layer is very thin, and an

¹ IRVING LANGMUIR, "Positive Ion Currents in the Positive Column of the Mercury Arc," *Gen. Elec. Rev.*, November, 1923.

enormous potential gradient is set up at the mercury surface which draws the electrons out by a cold cathode effect suggested by Schottky.¹ A gradient of the order of millions of volts per centimeter is required and the cathode drop is approximately 10 volts; so the space-charge film covering the cathode spot would be roughly 10^{-4} millimeters thick. It is readily apparent why this spot does not start of its own accord. If any ordinary potential were placed on two electrodes, it would distribute itself more or less uniformly over the space between them, and no gradient of the required amount would even be approached. The high gradient over the short distance is the peculiar characteristic connected with the cathode spot and allows it to emit the electrons under circumstances which tend to maintain the gradient; that is, the pressure of the mercury vapor immediately over the spot is quite high and the electrons go only a very short distance before producing positive ions which supply the positive-ion space charge necessary for the existence of the high gradient.

It is apparent that special means will be necessary to start the cathode spot. Spark coils can be used for the purpose, but the most satisfactory and reliable method is to use only a small voltage and apply it across an extremely small distance, that is, allow another electrode to come into contact with the mercury and then withdraw it.

Measurements of the phenomena of the cathode spot are quite difficult, and no data have been published which can be accepted without question. The figures given by Günther-Schulze² are among the best. He finds the area of the cathode spot to be 2.5×10^{-4} cm.² per ampere or that the current is 4000 amperes per square centimeter of spot. The mercury evaporated is 7.2×10^{-3} grams per second per ampere and the cathode drop he finds to be 9 volts. This is slightly less than the ionizing potential of

¹ SCHOTTKY, *Z. Physik*, vol. 14, p. 80, 1923.

² GÜNTHER-SCHULZE, "Mercury Rectifiers and Their Physical Foundations," *Engineering Progress*, pp. 251-256, August, 1925. A full description of Dr. Langmuir's theory with data has not yet been published (October, 1926).

mercury (10.4 volts), but as the ionization may result from the cumulative effect of the impacts of more than one electron, this figure is very reasonable. In the sheath above the cathode spot he believes that 56 per cent of the current is due to electrons leaving the mercury and 44 per cent is due to positive ions entering the mercury from the ionized vapor. The velocity of the positive ions striking the mercury is that acquired by falling through the potential drop of 9 volts, so that for every ampere of total cathode current there will be an input of $0.44 \text{ ampere} \times 9 \text{ volts}$, or 3.96 watts to the mercury surface. On entering the mercury, the ions are neutralized by combination with electrons and this releases further energy equal to 3.1 watts. The total energy input to the mercury is thus 7.06 watts per ampere.

This energy is used in four ways: radiation, conduction of heat from the mercury forming one side of the cathode spot, heat used in evaporation of the mercury, and consumption of energy by the electrons leaving the mercury. This last represents the energy required to separate the electrons from the mercury against the electrical forces tending to retain them in the metal. Günther-Schulze divides the total energy as follows:

1. The consumption of energy by the electrons on leaving the mercury.....	2.20 watts
2. The evaporation of the mercury.....	2.20 watts
3. Radiation.....	0.04 watt
4. Conduction of heat from the spot by the liquid mercury.....	2.68 watts
Total.....	7.12 watts ¹

¹ The difference between this figure (7.12 watts) and the product of a 9-volt cathode drop and a 1-ampere current is used in producing ionization in the space above the cathode spot. The electrons in passing outward through the cathode drop acquire an energy represented by $0.56 \text{ ampere} \times 9 \text{ volts}$, or 5.04 watts, which is used in making ionizing collisions, but 3.1 watts of this is returned to the cathode spot by the positive ions which enter it and are neutralized. This leaves a net transfer into the ionized space of 1.94 watts per ampere giving a total loss of $(7.12 + 1.94)$, or 9.06 watts.

This is equal to the input to the mercury except for a very small discrepancy.

Günther-Schulze's figure for radiation is compatible with a cathode temperature of 3000° , a figure which appears to be much too high. A temperature of 3000° would undoubtedly show a continuous spectrum instead of the characteristic line spectrum. The radiation factor, however, is negligible in any case. The figures as given are quite valuable, as they indicate very well the nature of the various phenomena of the cathode spot.

After leaving the mercury surface, the electrons are accelerated by the electric field and when they have passed through the sheath above the cathode spot, they are able to ionize mercury molecules by collision. In this manner part of the energy due to the passage of the ions and electrons through the cathode drop of 9 volts passes into the ionized gas directly without entering into any of the reactions of the spot itself.

The evaporation of the mercury from the cathode spot results in a tremendous pressure directly over the spot and this depresses the mercury surface at this point. The spot itself, however, does not stay in the bottom of the depression formed in this manner but climbs up the side, whereupon the pressure is applied to the new point and the spot moves swiftly across the surface of the mercury with many erratic changes in direction.

For very small currents the cathode spot is unstable; that is, the conditions which maintain the spot are easily disturbed so that it is extinguished. The exact minimum value of current which can flow with assurance that this will not occur depends on various circumstances, but 5 amperes is usually sufficient. If the load current through the tube is not always at least this large, it is necessary to provide additional electrodes to carry a small holding arc. This is done by using two small electrodes just above the mercury supplied with energy from a small transformer and operating as a low-voltage rectifier. The loss incurred in this way is usually less than 100 watts.

Losses in Arc Stream.

The main portion of the path taken by the current in passing between the anode and cathode is through ionized vapor of somewhat uniform nature. This vapor contains electrons, positive ions, neutral molecules, and negative ions (formed by electrons attaching themselves to neutral molecules). All the particles of the vapor have a random motion with velocities of each type of particle distributed in accordance with Maxwell's distribution law from the kinetic theory of gases.¹ The connection between the velocities of the different types of particles, however, is not what would be expected from the theory of gases—the velocities of the electrons, for instance, giving them very much more kinetic energy than that connected with the neutral molecules.

Beside their random velocities the electrons will have a general drift velocity toward the anodes, while the positive ions will move toward the cathode and the neutral mercury vapor will move toward the coolest parts of the tube where it is condensed. The drift velocities are small compared with the velocities of random motion. The most interesting of them, of course, is the drift motion of the electrons on which the conduction of the current depends, the motion of the positive ions being quite small in comparison. (The electron moves about 600 times as fast as the positive ion.)

Throughout the ionized vapor there will be excited atoms, that is, atoms with electrons partially removed so that they are traveling in paths from which they can sink to more stable orbits with the radiation of light. This, of course, represents a loss of energy, and another loss occurs due to electrons and positive ions recombining, particularly where they strike the walls of the tube. Also, the passage of current adds to the random velocities of the vapor molecules, thus heating the gas. To overcome these losses there must be a potential gradient along the path of

¹ IRVING LANGMUIR and HAROLD MOTT-SMITH JR., "Studies of Electric Discharges in Gases at Low Pressures," *Gen. Elec. Rev.*, July, August, September, November, and December, 1924.

the current so that the electrons are continually accelerated. They can then give up the velocity acquired in this manner by making collisions and thus replace the losses. The voltage drop required to maintain the ionization in the arc stream depends on the temperature of the vapor, the current, and the proximity of the surfaces collecting the ions and electrons. In rectifiers of the usual types of construction it is between 5 and 15 volts.

Conditions at the Anodes.

Since the anodes do not emit positive ions, the anode current represents electrons collected from the ionized vapor. The electrons in the vicinity of the anode have already been seen to have a random motion in all directions, and a large number of them would hit it if it were at the potential of the surrounding space and had no electric field to attract or repel charged particles. In the same manner a much smaller number of positive ions would also strike it. If the current due to these two actions should be equal to that being conducted by the rectifier, there would be no anode drop.

If the product of random current and anode area is less than the load current, there will be an electric field around the anode tending to collect the electrons and repel the positive ions. This field will form a sheath around the anode of such a size that the outer surface of the sheath will have an area of sufficient size to collect the necessary electrons as they drift about with random motions.¹ In other words, the product of this area and the random current will be the load current.

Inside the sheath the electrons will be accelerated and drawn toward the anode. On striking it they will give up their kinetic energy and also will give up further energy when they enter the anode material, aided by the surface forces tending to retain them inside. This latter energy corresponds to that given to them when they escaped from the mercury of the cathode.

¹ IRVING LANGMUIR and HAROLD MOTT-SMITH, JR., *loc. cit.*

It may happen that the product of the random current and anode area will be greater than the load current. In this case there will actually be a small negative drop at the anode repelling the extra electrons. Attempts have been made to build mercury arc rectifiers taking advantage of this, but it is not easy to get a design in which the gain in efficiency is large enough to warrant overcoming the difficulties which are involved in the construction and exhaust of the tube.

In the ordinary mercury arc rectifier, however, it is essential to guard against a high anode drop. Dr. Langmuir¹ has shown that the random current is usually between one and one-half to four times the drift current. If, therefore, the anode area be a considerable fraction of the cross-section of the arm in which it is located, it is very unlikely that there will be an excessive drop.

It is apparent that the anodes will have to dissipate a loss of several watts per ampere because the entrance of the electrons into the anode material is alone equivalent to the work done in passing through a potential drop of 3 or 4 volts (the so-called work function of the material), and even with a retarding field around the anode, many electrons cannot be prevented from striking it with a velocity equivalent to another volt or two.

Part of the power dissipated by the anodes will be conducted away but a large portion of it is radiated. This means that the anodes must run at a fairly high temperature. While metal anodes are used with satisfaction, there are particular advantages connected with carbon. It has a high melting point, it is an efficient radiator, and the gases absorbed in it are easily removed by heating. For these reasons it is almost universally used in the glass rectifier tubes.

The Condensing Chamber.

The mercury which is evaporated from the cathode spot is condensed in a chamber immediately above the cathode

¹ IRVING LANGMUIR and HAROLD MOTT-SMITH, JR., *loc. cit.*

and runs back again. The temperature at which the mercury is condensed is very important, for the condensing

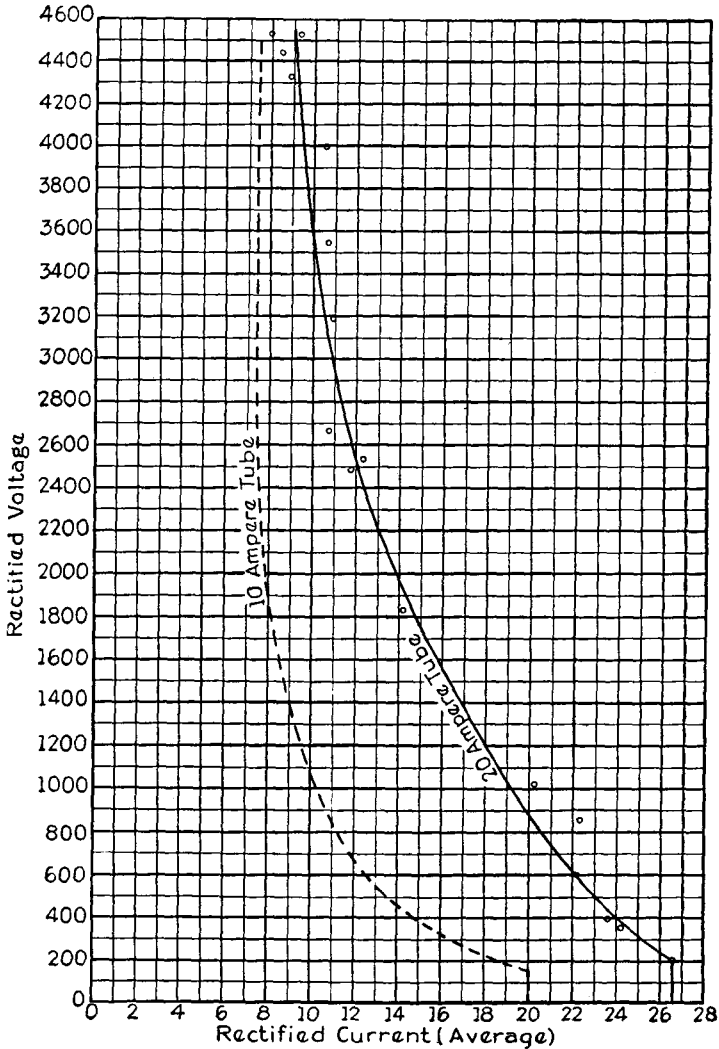

FIGURE 22.—Arc-back curves for 10- and 20-ampere tubes with bent arms. Cooled by natural air circulation.

chamber is the coolest part of the rectifier and determines the temperature and pressure of the mercury vapor. It is found that successful operation requires that the vapor

pressure be within a certain range; if it is too high, arc-back occurs; if it is too low, the arc-drop is excessive. These points are discussed more in detail in the next two chapters.

The question of arc-back has received much study, and although the exact mechanism is unknown, there are indications of its nature. For any particular glass rectifier tube the current and voltage at which arc-back occurs are related as shown in figure 22. With an increase in load current the temperature of the rectifier increases and its ability to hold back the inverse voltage decreases. It is apparent that this is one of the most important phenomena connected with the rectifiers and that it must be intimately connected with the area of the condensing bulb in glass tubes which depend on air cooling. In iron-tank rectifiers the area of the condensing chamber may be smaller for its temperature can then be controlled by water jackets on the outside of the tank.

Care must be taken to supply a path of large cross-section from the cathode to the condensing chamber. At the low pressures of mercury vapor used the volume to be condensed is astonishing and it cannot pass through any but the largest opening without suffering an increase in pressure. If this occurs, the pressure is transmitted to the anode arms with a corresponding rise in arc-drop and decrease in the arc-back voltage.

CHAPTER V

SOME PHYSICAL PROPERTIES OF MERCURY ARC RECTIFIERS

Arc-drop Curve.

In the preceding chapter, the phenomena which give rise to the arc-drop were discussed. Now the value of arc-drop as determined experimentally will be considered. Figure 23 shows the arc-drop curves for standard 20-ampere glass rectifier tubes. These curves are all fairly flat with a point giving minimum voltage drop. Six curves are shown altogether, but several are practically coincident. Between 6 and 20 amperes, curves were taken on a tube with short straight arms and a tube with longer arms containing a 90-degree bend to protect the idle anode from bombardment by positive ions. The arc-drop was about 4 volts greater for the tube with bent arms than for the one with straight arms. Measurements were made with a steady current from one anode and a steady current divided between the anodes, but this appeared to make very little difference in the voltage drop. These first curves were taken with only natural air circulation to cool the tubes. Two other curves extending between 6 and 45 amperes show the arc-drop obtained when the tubes were cooled by means of a 12-inch desk fan. For these curves, the current was divided between the two anodes.

The effect of temperature on arc-drop is quite marked. When the tubes were cooled by the fan, currents about three times those previously carried resulted in approximately the same value of arc-drop. This phenomenon is quite useful at times, but it may also result in serious difficulties. Suppose a tube is so designed that the arc-drop is lowest when it is carrying a fairly heavy load. If then the load

be suddenly applied when the tube is cold, a higher arc-drop will result. The increased loss would not be serious if it were distributed throughout the tube, but this is not

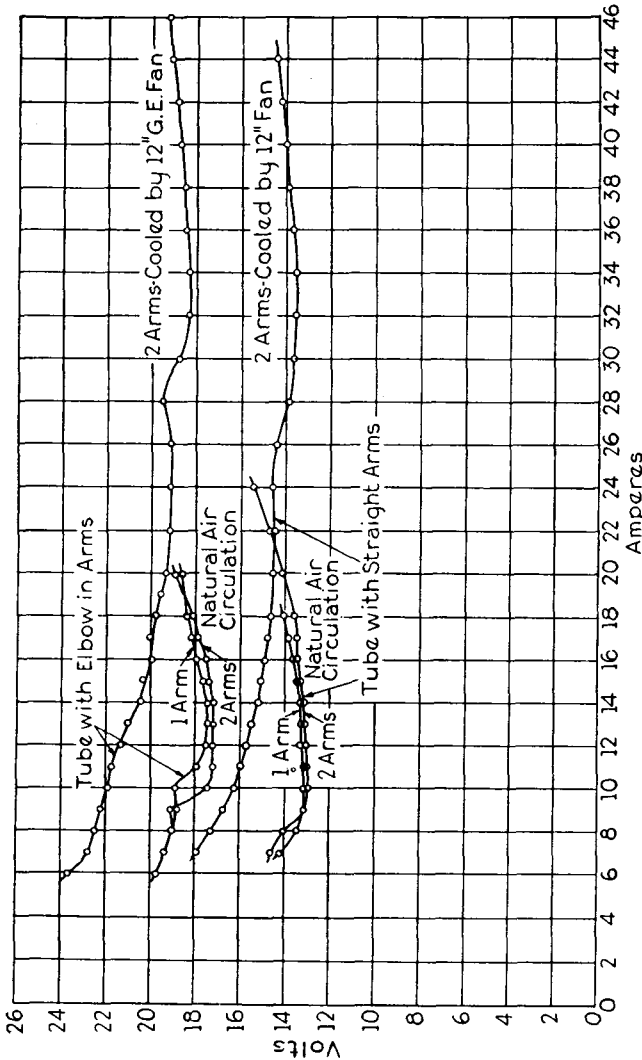

FIGURE 23.—Arc-drop curves of 20-ampere tubes. Taken with direct current. Ambient temperature, 25°C.

the case. A large portion of the additional loss has to be dissipated by the anodes, and this results in considerable overload upon them for, under normal conditions, they

have to radiate only a small fraction of the total loss inside the tube. The anodes, therefore, heat very rapidly and may be overheated before the remainder of the tube reaches a temperature resulting in normal anode losses.

The fact that the arc-drop is dependent almost entirely upon the temperature caused by the passage of the current and not by the current itself is further illustrated by the small difference in voltage between the curves where only one anode carries current and where both carry current. In either case, the total loss inside the tube is the same. Hence, the temperatures are the same and the arc-drops are equal. Arc-drop is, therefore, largely a function of the total current carried by a rectifier rather than the current to a particular anode.

Instantaneous Arc-drop.

The arc-drop curves which have just been discussed were taken with steady currents, and the question, therefore,

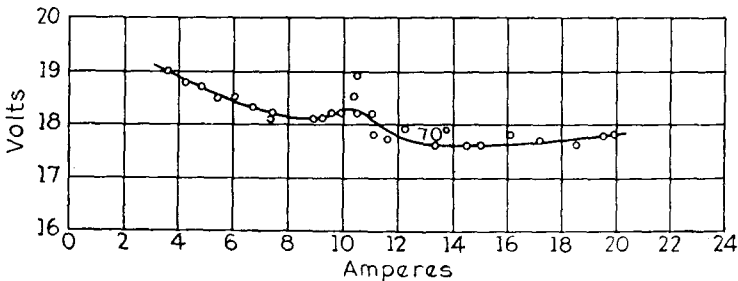

FIGURE 24.—Arc-drop curve of a 20-ampere tube under oil at 70°C. Taken with direct current.

arises whether the results obtained with steady currents can be applied to a tube rectifying an alternating current provided the temperature is the same. Figures 24 and 25 answer this question. Figure 24 shows the steady current arc-drop curve of a 20-ampere tube with bent arms submerged in oil at 70 degrees and figure 25 shows the current wave form and measured arc-drop while running as a rectifier under the same conditions of temperature. The dotted arc-drop curve was obtained by taking the

values of arc-drop from figure 24. The correspondence between the two curves is very close. There is a slight although not easily measurable difference which may be attributed to the time lag in adjustment of the ionization

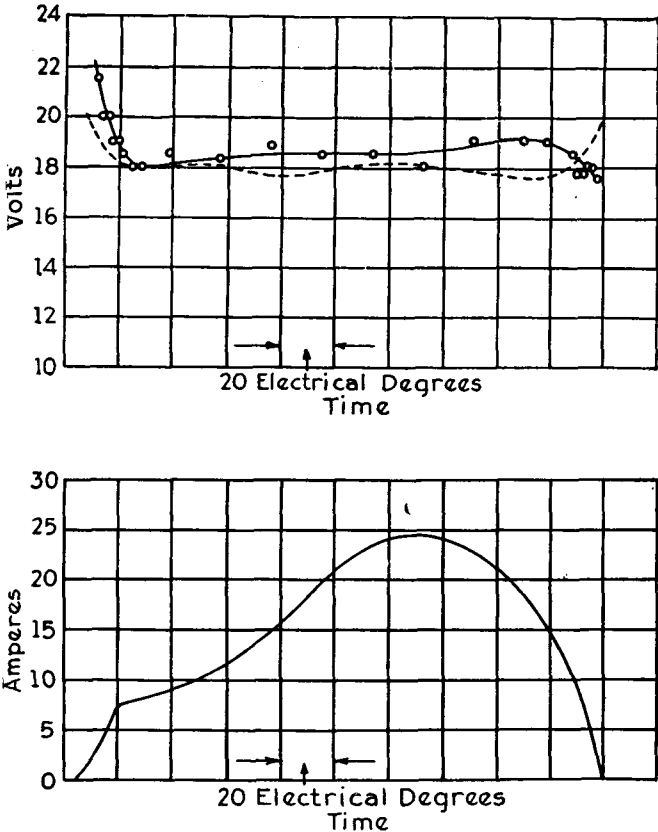

FIGURE 25.—Arc-drop of a 20-ampere tube under operating conditions. The lower curve shows the current-wave form and the upper curves show the measured arc-drop and arc-drop as obtained from figure 24. Tube under oil at 70°C.

of the vapor. For practical purposes, the arc-drop may be estimated from curves obtained with steady currents.

Parallel Operation of Rectifier Tubes.

If two rectifier tubes or two anodes in the same tube are connected in parallel and the current carried is of such a

value that the arc-drop curves show a decrease in voltage with an increase in current, it is obvious that parallel conduction of current will represent an unstable state and one tube will carry the entire current. This instability also extends to the portion of the curves where the voltage increases with the current—apparently the indicated increment in voltage does not appear simultaneously with a change in current. Tubes can be operated in parallel by two schemes. For experimental work, resistances in series with each anode are usually satisfactory. The drop across them need be only a few volts. In commercial rectifiers, this resistance loss can be avoided by the use of a current-dividing compensator. This compensator resembles a small autotransformer with a tap in the middle of the winding. The anodes are connected to the ends of the winding and the current enters through the midtap. If it does not divide equally, there will be a voltage induced in the compensator favoring the anode which is not receiving its share. With normal operation, however, the currents in each half winding are changing at the same rate and no voltage is induced.

Failure of Mercury Arc Rectifiers at Low Voltages.

At low voltages, the failure of mercury arc rectifiers is usually the result of the overheating of some part due to excessive current. Anodes or anode leads may be melted off, seals may be cracked, the anode arms may be melted or gas may be driven from some of the parts. When glass mercury arc rectifiers are exhausted at the factory, the parts are heated by the passage of a current, and the gases evolved are pumped out. This process is continued until no more gas is given off, and then the tube is sealed. As foreign gases inside the tube very seriously impair its operation, it will be seen that a thorough exhaust is of great importance. If the tube is heated in service beyond the temperature to which it was raised during exhaust, gases are liberated by the overheated parts and the tube may be ruined.

Signs of Poor Vacuum or High Vapor Pressure.

The presence of foreign gases in a glass mercury arc rectifier may be detected by the color of the light given off by the vapor. This light is due to electrons changing their orbits inside the atoms. This can occur in several ways and transitions of each type result in the emission of light of a particular frequency. Examined through a spectroscope, therefore, the light due to mercury alone consists of several bright lines in the yellow, green, and violet, and a much weaker line in the red with dark spaces between. Most of the gases which can get into a tube give off much more red light than the mercury and the glow will, therefore, appear pinkish instead of the normal blue-green color if these impurities are present. If a small hand spectroscope is used, the nature of the impurities can be determined and the amount present estimated roughly, but examination of the tube through a piece of red glass or even with the naked eye will often give a good idea of its condition to an experienced observer.

If the mercury vapor pressure is high, which may be due either to an overload or to the presence of foreign gases,¹ the arc will not remain in its diffuse form but will appear as narrow "caterpillars" between the anodes and cathode. These paths will be fixed in location and very hot. If they touch the glassware in going around the bend of an arm, they are almost certain to crack or melt it.

Most of the impurities which may be inside a tube can be "cleaned up" by the mercury vapor if they are not present in too great amount. This is accomplished by the formation of compounds of the mercury and the impurities which stick to the surface of the condensing chamber and give it a mirror-like appearance. As long as they remain in this position, the tube will be found to be quite "hard," but if the tube heats very much, this sludge will run down into the cathode pool and the gases will be released again.

¹ The foreign gases increase the pressure by interfering with dissipation of the losses and thereby raising the temperature.

Testing the Vacuum of Glass Rectifier Tubes.

The vacuum of small rectifier tubes which are not in operation can be readily tested by either the "click" or the "bubble" test. If there are no foreign gases inside a tube, there will be nothing to cushion the impact of the mercury on the glass if it is allowed to flow quickly into some pocket in the tube such as the cathode pool or starting electrode cavity. A sharp click will then be given off due to the blow delivered to the glass. If there are gases present, the sound given off will be quite dead in comparison. It is obvious that some discretion must be used in making this test so that the mercury may not strike the glass a blow sufficient to break it. This test is not always easy to make. On some tubes, the disks which are placed on the ends of the cathode and starting electrode leads to prevent excessive mercury hammer are so effective in their action that the test cannot be made except by swishing the mercury around in the condensing bulb and noticing the noise which it makes there.

The "bubble" test consists in running the mercury from the main body of the tube into the cathode pool and noting whether or not it is possible to see any bubbles of gas escaping through the mercury after being trapped below it. A few small bubbles of gas adhering to the glass do not necessarily mean a poor tube, but, if they are large enough to escape from under the mercury, the condition of the tube is bad. This test often has to be repeated five or six times before the bubbles will be trapped and their escape noticed for the motion of both the mercury and the bubbles is quick enough to be fairly difficult to follow. Occasionally the mercury will not close in completely about the disk on the end of the cathode lead. This does not necessarily indicate the presence of gas in the space; the disk may be so near to the glass that the surface tension of the mercury will prevent it from closing in.

In applying these tests, there may be some question as to which should be used as a final criterion. If the "bubble" test shows the tube to be bad, it is truly bad and,

while an occasional sharp click may be heard from such a tube, it will be found that only good tubes give repeated sharp clicks with comparative sluggish movement of the mercury. If the "bubble" test does not result in the production of bubbles but causes loud clicks to be given off, it should be discontinued and the tube assumed to be all right. If neither test appears to give decisive results, it is probable that the tube contains gas and that motion of the mercury has not been rapid enough to catch it for the "bubble" test.

Arc-back.

The failures due to overheating of rectifier tubes are easily dealt with as the manner of failure and parts to be increased in size can usually be readily determined. With higher voltages and lower currents, failure occurs in a different manner which is not yet fully understood. Arc-back consists in loss of rectifying property so that current is passed by the tube in either direction. The high current passed under this condition heats the electrodes rapidly, but, if the circuit is opened quickly enough by the protective apparatus, no damage may result. At other times, the arc may attack the glassware around the anode seals and damage the tube permanently.

The voltage which a given tube can rectify is seriously reduced by the presence of foreign gases. If, however, these gases are completely removed, arc-back will be found to occur at a definite voltage depending on the current rectified. Figure 22 shows such curves for standard 10- and 20-ampere tubes (single phase). The short vertical section at the high-current end of each curve represents failure due to overheating, but the remainder of each curve indicates the load at which arc-back occurs. Cooling a tube by blowing air on it increases the loads required to cause arc-back, but the arc-back curve still retains the same general form. Reactance in the alternating-current supply lines has a very slight effect on the arc-back curve, but, unless the reactance is much more than normal, it is practically

impossible to measure its effect. There is no measurable difference due to frequency over the range of commercial frequencies, but higher frequencies undoubtedly affect the performance adversely.

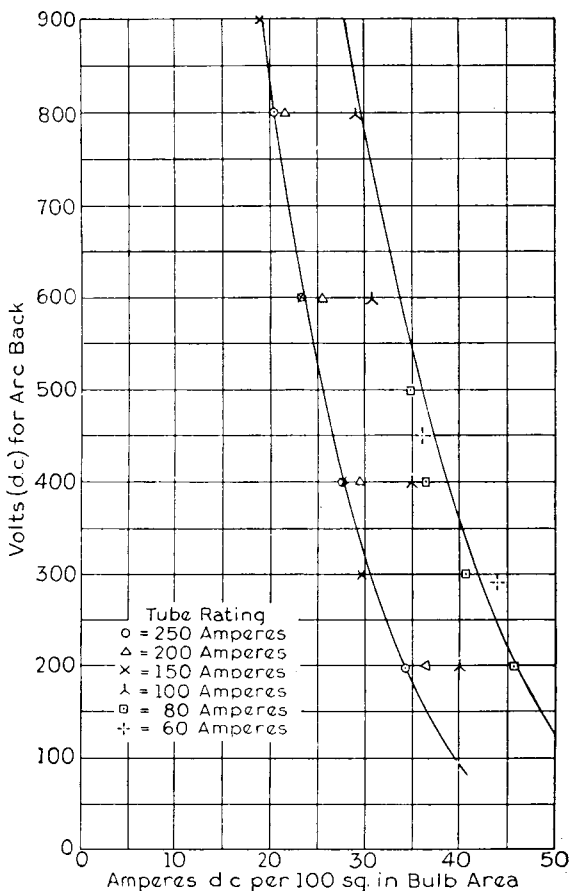

FIGURE 26.—Arc-back of glass mercury arc rectifiers as a function of size, bent arms, fan cooled.

Arc-back is largely connected with the actual size of a tube because this determines to a great extent the temperature it will acquire due to a given load. Figure 26 shows the relation between the arc-back voltage and the amperes rectified per 100 square inches of bulb area for a line of

rectifier tubes ranging in rating from 60 to 250 amperes. The higher curve represents tubes with a large passage from the cathode pool to the condensing bulb. Several tubes with a less generous passage did not have so low a

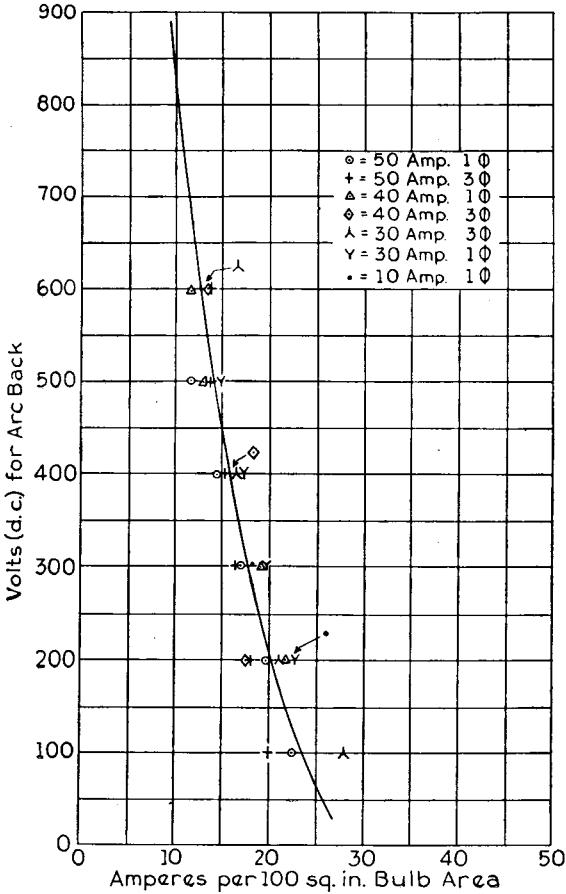

FIGURE 27.—Arc-back of glass mercury arc rectifiers as a function of size, bent arms, natural circulation.

pressure over the cathode for the same conditions in the bulb and, hence, arced-back at a lower voltage, as shown by the second curve. The curves of figure 26 were obtained with tubes cooled by a fan. A similar curve for tubes with only natural air circulation for cooling is shown in

figure 27. A comparison of the two indicates the advantages of the cooling.

Arc-back below Normal Value of Load.

Arc-back will sometimes be found to occur at a load much lower than expected. A common reason for this is foreign gases inside the rectifier, but difficulty will sometimes be encountered when this is not the cause. Cold anodes may be a cause of premature arc-back. In this case, the condensation of the mercury on the anode causes the formation of a cathode spot there. This difficulty is not met with in glass-type rectifiers, but can occur with the large iron-tank rectifiers where cooling of the anodes is resorted to. The phenomenon in other cases may often be traced to globules of condensed mercury falling onto hot anodes or to some other transient effect. Such arc-backs should not be confused with arc-backs resulting from a failure of the properties of a rectifier unaffected by any irregular occurrence. The former can be avoided by painstaking design, but the failure of a tube under normal conditions when the rated load has been passed is the natural limit inherent in the design.

The problem of arc-back is one of the most important connected with rectifiers, and a thorough knowledge of this phenomenon is much to be desired. Unfortunately, it is not yet completely understood, and the discussion of it must consist of a description of a series of tests indicating its nature although not explaining it completely. As this requires considerable space, it will be deferred until the next chapter which considers arc-back alone.

Flashing.

Flashing is somewhat akin to arc-back, but does not produce such serious results. It apparently represents at least a partial loss of rectifying property in which the reverse current which is allowed to flow in connection with the voltage available results in a "cleanup" of the gas causing the flash. The whole action is so quick that no

damage results, and the disturbance in the circuits is slight. Flashing usually begins when a tube is loaded to 60 or 70 per cent of the arc-back value and occurs with increasing frequency as the load is increased until a point is reached where the disturbance suddenly becomes much more severe and practically continuous, and this represents arc-back.

Fading.

Fading is a very annoying phenomenon which occurs in glass tubes having long arms with bends in them. It is caused by charges on the glass arms shielding the anodes

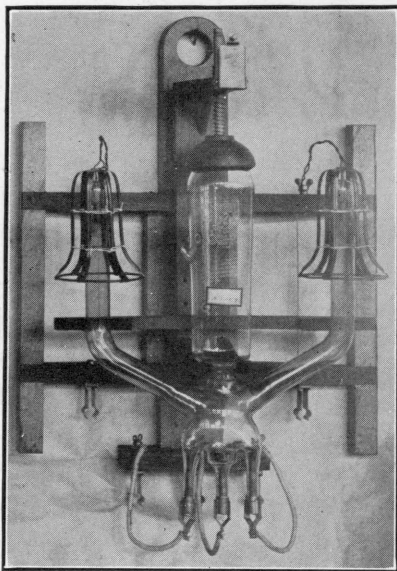

FIGURE 28.—Series arc tube in tube holder and fitted with static protectors.

to such an extent that the potential applied to them has difficulty in causing the arc to strike when an anode becomes positive. Under such conditions, the cathode spot may be extinguished, for the cathode current may fall to a value insufficient to maintain it. Fading is much more likely to occur in tubes which are cold rather than in those which are warm, and with lightly loaded tubes it is sometimes advisable to hinder the air circulation about them in

order that they may reach a satisfactory operating temperature. Another scheme for avoiding fading is shown in figure 28. Here a metal skirt is placed over the anode arm and connected to the anode and the field of this overcomes the shielding of the charges on the glass. The tube shown in this illustration is designed for supplying current to series arc lights and runs immersed in oil.

Factors Causing Tubes to Wear Out.

Glass mercury arc rectifier tubes "wear out" due to removal of material from the anode by positive-ion bombardment. The loss of this material is not sufficient to affect the anodes themselves, but it is deposited on the glass arms and interferes with the radiation of heat from the anodes. It also acts as an electric shield and may thus cause fading. It is probable that the poor operation obtained under this condition increases the punishment of the anode material. In any case, the sudden changes in voltage which a fading tube causes in conjunction with connected apparatus are sufficiently violent to make such operation undesirable and it may often be advisable to discard an old tube before it fails completely.

The life of glass mercury arc rectifier tubes is not known very well. This is because they last so long under normal operating conditions that a complete life test on them would be an impracticable undertaking. Some tubes, of course, last much longer than others, and tubes have been known to be in operation after 15 years of service. A tube with too short an operating life is usually regarded by the factory as defective and adjustment is made on some basis. In general, it is possible to guarantee an average operating life of glass mercury arc rectifier tubes so long that the cost of replacements is very small compared with the value of the energy converted.

Cooling of Rectifiers.

As the temperature at which a mercury arc rectifier operates is of such importance, it is apparent that cooling

will be a frequent subject of discussion, and that data should be available for problems of this nature. The temperature problem presents two aspects. For tubes in continuous operation with constant load, it is necessary to know only the steady temperature which will result, but, for tubes which carry a heavy load for short intervals, it is also necessary to know the rate at which they heat up, and, in making tests, it is desirable to know how long they should run before assuming that they have reached a steady condition.

Cooling of Glass.

Tests made on glass indicate that it radiates heat at a rate very close to that of a theoretical black body. For a black body at 100°C. in a region at 27°C. the losses by convection and radiation are 0.12 watts per cm.²,¹ or 0.001645 watts per cm.² per degree Centigrade or 0.0106 watts per in.² per degree Centigrade, assuming that the losses may be expressed as proportional to the difference in temperature.

In order to indicate the relative effectiveness of various methods of cooling, a small bulb was filled with water and cooled by various means. From the rate at which the water cooled, the watts lost per square inch of surface per degree difference in temperature are readily calculated. The thermal resistivity of the glass is assumed to be such that a drop in temperature of 1.6°C. took place in the glass per watt per square inch. While the figures obtained are not particularly accurate, they serve as a useful guide in the solution of problems which usually contain other approximations.

In Table I, "surface circulation" refers to the cooling medium flowing over the bulb in a thin sheet and, therefore, moving quite rapidly. "General circulation" represents a condition where the bulb was submerged and the cooling medium had a general circulation. The effective thermal

¹ IRVING LANGMUIR, "Conduction and Radiation of Heat," *Trans. Am. Electrochem. Soc.*, 1913.

TABLE I
EFFECTIVENESS OF VARIOUS MEANS OF COOLING

Cooling medium	Type of circulation	Effective thermal conductivity	Effective thermal resistivity	Thermal resistivity of cooling medium
		Watts per square inch per degree Centigrade	Degrees Centigrade per watt per square inch	Degrees Centigrade per watt per square inch
Water.....	Surface	0.376	2.66	1.06
Water.....	General	0.294	3.40	1.80
Water.....	None	0.168	5.96	4.36
Oil.....	Surface	0.159	6.28	4.68
Oil.....	General	0.0742	13.5	11.9
Oil.....	None	0.0494	20.3	18.7
Air.....	Fan	0.0328	30.5	28.9
Air.....	None	0.00716	139.6	138.0

conductivity is that of the path through both the glass and the cooling medium to a point of ambient temperature, and the effective thermal resistivity applies to the same path. The thermal resistivity of the glass is deducted from the latter figure to give the thermal resistivity of the cooling medium.

The cooling of metal rectifiers by means of water jackets is usually so effective that there is danger of having too low a temperature inside the tank rather than of overheating it. Hence, special control means may be necessary in order to maintain the proper temperature. Large glass rectifiers cooled by blowers may also require some means of decreasing the air supply when the tubes are lightly loaded or when they are starting up. Such problems are not peculiar to rectifiers and will not be discussed here. As explained in the first part of this chapter, the anodes of a tube which is not warm enough have to dissipate an excessive amount of power; in addition, the holding arcs will often be found unsteady.

Local heating around the anode seals of glass rectifiers is sometimes desirable. If a tube is operating at high voltage and low current, the anode seals will usually be fairly cool and mercury will condense there and fall on the anodes, thus causing a preventable arc-back. This can be avoided by wrapping the ends of the arms with asbestos tape so that they will be at a higher temperature.

Rate of Heating of Glass Rectifier Tubes.

The rate at which the condensing bulb of a glass rectifier tube heats up is dependent to a large extent upon the glass of which it is made. As different glasses vary widely in their chemical and thermal properties, and as the thickness of bulbs is bound to vary, it is not worth while to insist upon an exact knowledge of these factors. Instead, reasonable values will be assumed for them and a general solution obtained for all bulbs cooled by natural air circulation. In doing this, it will be assumed that heat energy leaves the mercury vapor and enters the glass at a constant rate. This is well justified as the energy must enter the condenser bulb at a fairly uniform rate, and it cannot very well be stored in the small amount of mercury vapor present.

Assuming, therefore, that:

C = heat-storage capacity per square centimeter of bulb
in calories per degree increase in mean temperature,

I = rate of input of energy (calories per cm.² per second),

$\frac{1}{r}$ = rate at which heat is lost per square centimeter per
degree difference in temperature between bulb
and surrounding air (calories per cm.² per degree
Centigrade),

t_0 = temperature of air (ambient temperature), also
starting temperature of glass,

t_1 = final mean steady-state temperature of the glass
(treated as uniform throughout its thickness),

t = mean temperature of the glass at any time (treated
as uniform throughout its thickness),

T = time elapsed since starting of tube,

it is then readily shown that

$$(t - t_0) = (t_1 - t_0)(1 - e^{-\frac{T}{rc}}) \quad (4)$$

where $(t_1 - t_0) = Ir.$ (5)

The value of C is given by the product of the thickness and volumetric specific heat of the glass and will be assumed to be 0.16 centimeter \times 0.48 calories per degree Centigrade per cm.³, or 0.0768 calories per degree Centigrade per cm.² $\frac{1}{r}$ is not a constant except for small temperature differences but will be assumed as such as was done in calculating the steady-state temperatures. The value 0.001645 watts per cm.² per degree Centigrade previously given is equivalent to 0.000394 calories per cm.² per degree Centigrade per second. The substitution of these values in equation (5) results in

$$(t - t_0) = (t_1 - t_0)(1 - e^{-0.00513T})$$

and the time required for the temperature difference to reach 95 per cent of its final value is given by

$$e^{-0.00513T} = 0.05$$

from which T is found to be 583 seconds.

This value is in accordance with experimental observations. Tubes being tested for arc-back usually fail within 15 minutes after applying the load required to cause breakdown. Tubes containing gas held in sludge or adsorbed in the glass may take longer to reach steady conditions of gas content, but this is because of the slow adjustment of the gas content.

CHAPTER VI

ARC-BACK OF MERCURY ARC RECTIFIERS

Explanations or theories of arc-back fall into two classes. First, arc-back may be considered to be due to some transient phenomenon occurring at the surface of the anodes resulting in the formation of cathode spots on them and, second, the failure may be considered to be due primarily to breakdown similar to that when insulation is ruptured. As yet, neither explanation is entirely proved or disproved, hence, either may be correct or the true explanation may involve phenomena of both types. Many tests have been made, however, which show certain explanations to be incorrect and indicate the true nature of the failure. This chapter will contain descriptions of this work.

Operating Conditions of Tubes.

In order to understand the nature of the different tests, it is necessary to have a knowledge of the conditions under which the tubes operate. The ordinary single-phase circuit with which most of the tests have been made is shown in figure 29. The wave shapes obtained with such a circuit are indicated by figure 30. In this oscillogram, one trace shows the voltage between anodes and the other shows the current flowing through one anode.

In general the voltage impressed by the transformer will consist of large portions of sine waves with marked irregularities occurring at the time one anode transfers its load current to the other. As the voltage drop in the rectifier is very low, the current will not start to be transferred from one anode to another until the potentials of the two are almost equal. Before this time, only one anode, the most positive, is carrying current. At the instant when

the voltage across the transformer reaches zero, the second anode will commence to draw current. If there were no reactance in the transformer windings to prevent it, the second anode would immediately take all the load current from the first, but this is impossible. Instead, the transfer of current requires a definite time. It is accomplished by the voltage induced in the transformer windings which rapidly increases in the proper sense for this purpose after transfer has commenced. The resistance of the rectifier or transformer windings plays only a very small part in the transfer, the voltage being used almost entirely in overcoming back electromotive forces due to the leakage reactance of the transformer windings which, of necessity, are carrying a rapidly varying current during this time. When transfer is completed, this variation in the current carried by the transformer windings stops and their full voltage, which has been entirely used up in overcoming leakage reactance, is suddenly applied to the rectifier.

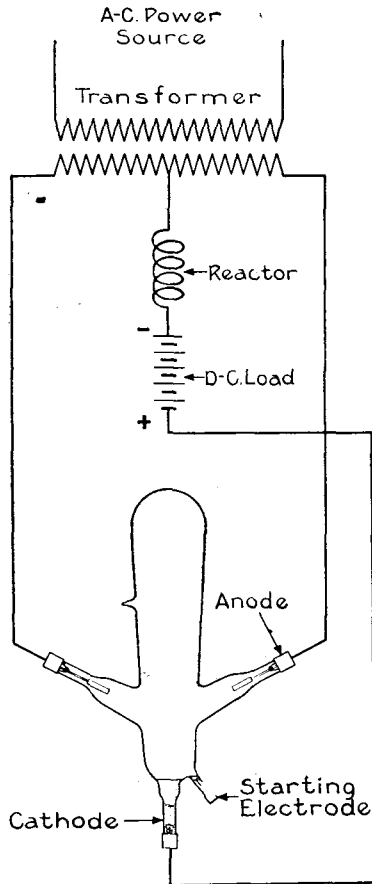

FIGURE 29.—Single-phase rectifier circuit.

The oscillogram shows this very well. After an interval of zero voltage across the transformer, the potential is suddenly applied to the rectifier and then follows a sine wave. As the load current or transformer reactance is increased, the interval required for commutation of the anode currents increases and the voltage which is suddenly

applied to the tube at the end of this interval receives a corresponding increment.

The load current is held steady by the choke in the output circuit. Hence, the anode current will be constant in value during the time when only one anode is operative and the sum of the two currents will be equal to the load

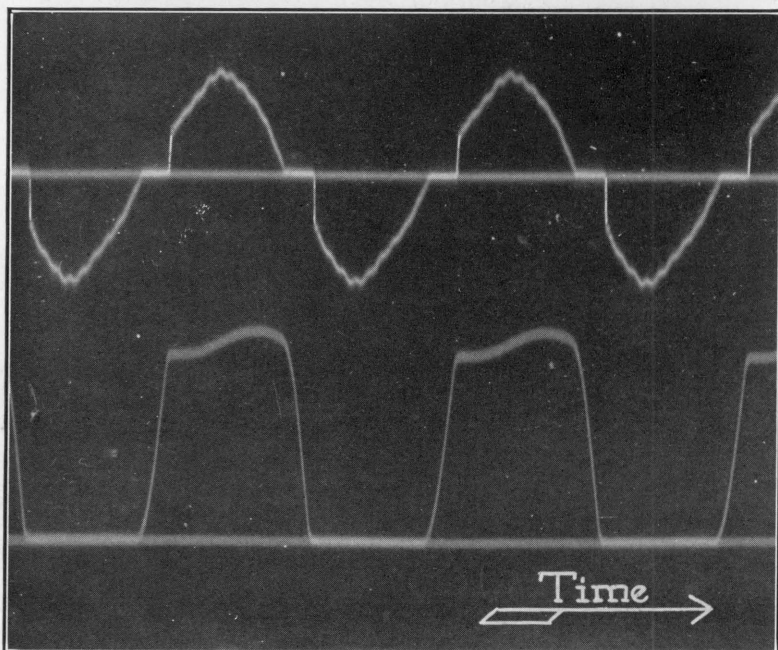

FIGURE 30.—Wave shapes obtained with a circuit of the type show in figure 29. The upper trace shows the voltage between anodes and the lower trace shows the current carried by one anode.

current during the period of transfer. As the choke cannot be perfect in its action, there will be slight irregularities representing its exciting current due to the ripple voltage of the rectifier which is absorbed by it instead of being passed on to the load.

Inverse Current.

After an anode has lost its current and the transformer voltage suddenly reappears, the anode which is then carry-

ing current and the cathode are at practically the same potential, and this means that the idle anode is negative with respect to the remainder of the rectifier by an amount equal to the transformer voltage. The anode arm will still be filled with residual ionization remaining after the current has ceased to flow and the negative potential of the anode will cause it to collect a good portion of the positive

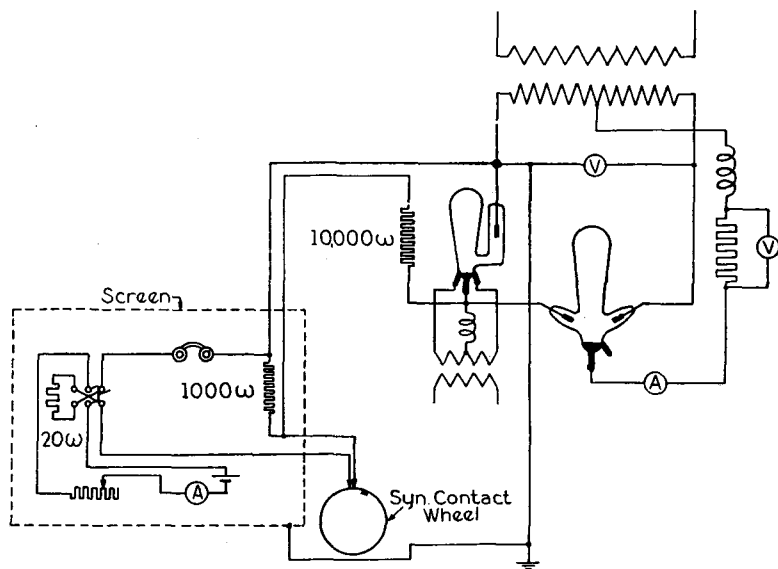

FIGURE 31.—Circuit for measuring inverse current.

ions in the arm. This represents an inverse current which has a peak value of the order of $\frac{1}{1000}$ of the load current or even much less. It does not, therefore, represent a serious loss in efficiency, but at first sight would appear a likely point at which to begin an investigation of arc-back.

The difficulty in measuring the inverse current lies in the high ratio of load to inverse current, for apparatus sensitive enough to measure the latter will be destroyed by the former. This is avoided in the circuit shown in figure 31 which is similar in many respects to a circuit originally suggested by Günther-Schulze¹ but slightly more direct

¹ *Electrotech. Z.*, Heft 2, 1910.

in its method of operation. The tube under test is operated as a single-phase, double-wave rectifier with a choke coil to smooth the rectified current. In one of the anode lines, there is a second rectifier tube the function of which is to pass the normal anode current but hold back the inverse current and cause it to flow through the measuring circuit. It is provided with a holding arc maintained by an ungrounded alternating-current circuit.

The inverse current flows through two resistances in series. The first of these has sufficient resistance to protect the operator making the measurements in case of accident. In this particular case 10,000 ohms were used. The second resistance has a value of about 1000 ohms and is changed as conditions require. By means of a storage battery and rheostat, a voltage comparable with that in the 1000-ohm resistance is produced across a 20-ohm spool. A synchronous contact wheel connects the two resistances together through a pair of telephones once each cycle. By changing the current in the 20-ohm spool until no noise is heard in the telephones, it is possible to measure the instantaneous inverse current in whatever part of the cycle for which the synchronous contact wheel may be set.

Considerable difficulty was experienced in making this circuit work in practice. It was found that the contact wheel required much attention and that the tube separating the normal current from the inverse current was a source of noise in the telephones unless the anode was placed in an arm having a bend to shield it from the disturbance produced in the bulb proper by the holding arcs. As fairly high voltages were used, it was also necessary to inclose the entire measuring circuit inside a grounded screen in order to avoid currents induced by electrostatic coupling.

The tests were run on tubes immersed in oil so that temperature, current, and voltage could be varied. Figures 32, 33, and 34 show some of the results obtained. It was thought that the inverse current might increase to the point where it would develop into an arc-back in some manner, but data could be taken near arc-back conditions

without any indication of this. Instead, the tubes would flash occasionally without causing any difference in the readings of the inverse current. It appears, therefore, that if there is any connection between arc-back and the inverse current, it is probably rather remote.

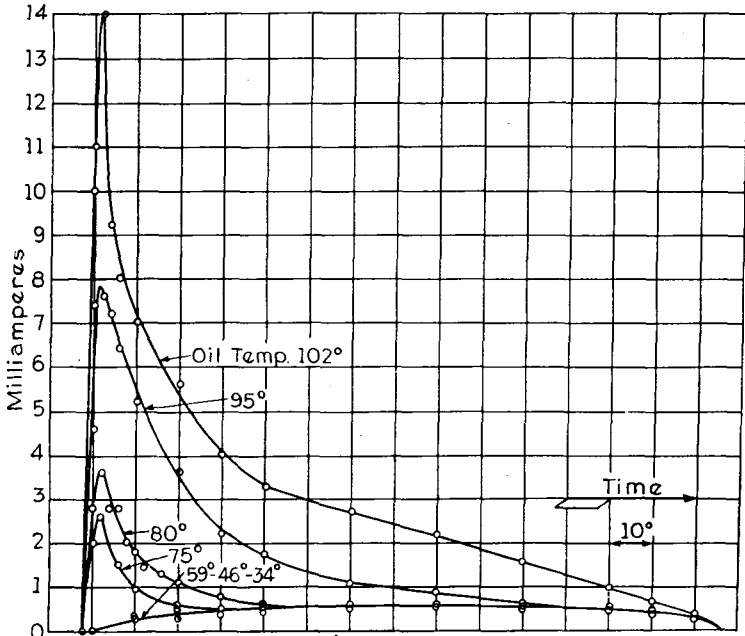

FIGURE 32.—Inverse current as a function of temperature of tube. Taken with a 20-ampere tube with short arms. Rectified current, 15 amperes, direct current. Alternating potential between anodes, 1350 volts. Frequency, 55 cycles. Operated with a smoothing reactor and no holding arc.

Effect of Wave Form and Frequency upon Arc-back.

The most violent bombardment to which an anode is subjected occurs almost immediately after it has ceased to carry the load current, for the inverse-current curves show it to be then collecting positive ions at the maximum rate, and its potential with respect to the rest of the tube, while not at a maximum, is of good magnitude. If arc-back is the result of the formation by bombardment of a cathode spot on the anode, this is the point in the cycle where it would be most likely to occur, and a change in frequency

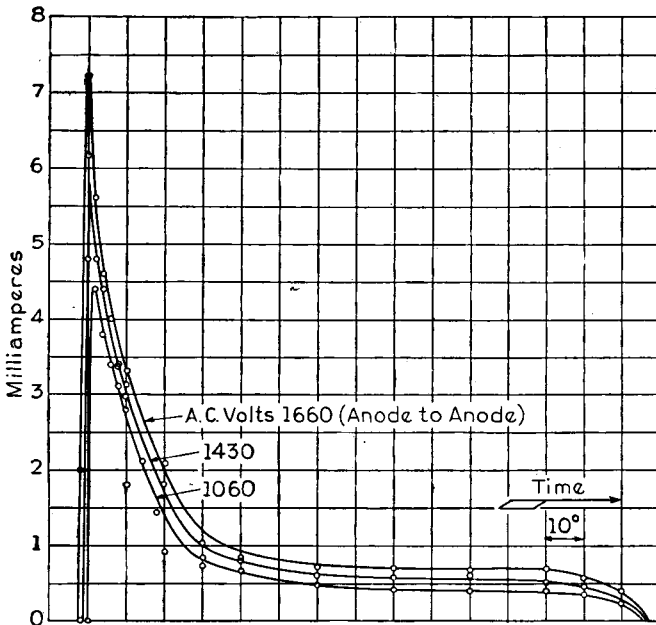

FIGURE 33.—Inverse current as a function of voltage. Taken with a 20-ampere tube with short arms. Rectified current, 15 amperes, direct current. Oil temperature, 85°. Frequency, 56 cycles. Operated with a smoothing reactor and no holding arc.

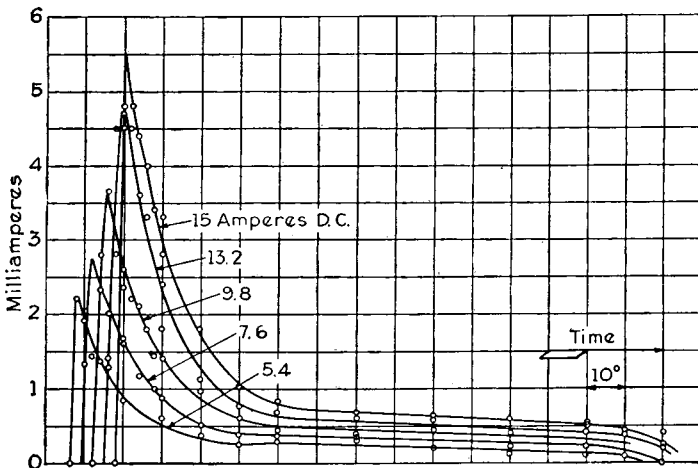

FIGURE 34.—Inverse current as a function of load current. Taken with a 20-ampere tube with short arms. Alternating potential between anodes, 1430 volts. Oil temperature, 85°. Frequency, 56 cycles. Operated with a smoothing reactor and no holding arc.

or a change in wave shape would be expected to change the load at which arc-back takes place. Measurements made at 30 and 60 cycles showed no difference in the load at which arc-back occurred that could be distinguished from the experimental errors involved.

The voltage wave shape can be changed by placing a large condenser across the secondary winding of the transformer. This prevents any sudden change in the voltage applied to the tube and, therefore, should materially affect the severity of the bombardment of the anodes by the positive ions. The change, produced in this way, in the load required to cause arc-back was so small that its existence could not be proved.

The voltage wave shape can also be changed by varying the reactance of the transformer windings. By adding reactance to the transformer, the period of commutation can be lengthened and the voltage applied immediately after commutation of the anode currents thereby increased. Measurements made with various reactances showed that a slight decrease in load required to cause arc-back occurred when the reactance was increased. The increase in punishment of the anodes, however, would appear to be capable of causing a much greater decrease in load-carrying ability than occurred. The difference was so small that at first it was thought to be an experimental error. Remembering that the longer period of commutation will result in higher instantaneous values of voltage throughout the remainder of the cycle if the output voltage is held constant, it is difficult to prove that the effect of reactance on arc-back is due to the change in punishment of the anodes by the positive-ion bombardment.

Point in Cycle at Which Arc-back Occurs.

Knowledge of the point in the cycle at which arc-back occurs is of considerable value in determining the nature of the phenomenon. Figure 35 is one of a group of oscillograms of arc-back of a tube which showed an unusual regularity in the time at which it failed after the overload

was applied, thus making it possible to obtain these records. The connections for this test are shown in figure 36. In each anode lead of the tube to be tested there is inserted a rectifier tube shunted by a resistance of about 300 ohms.

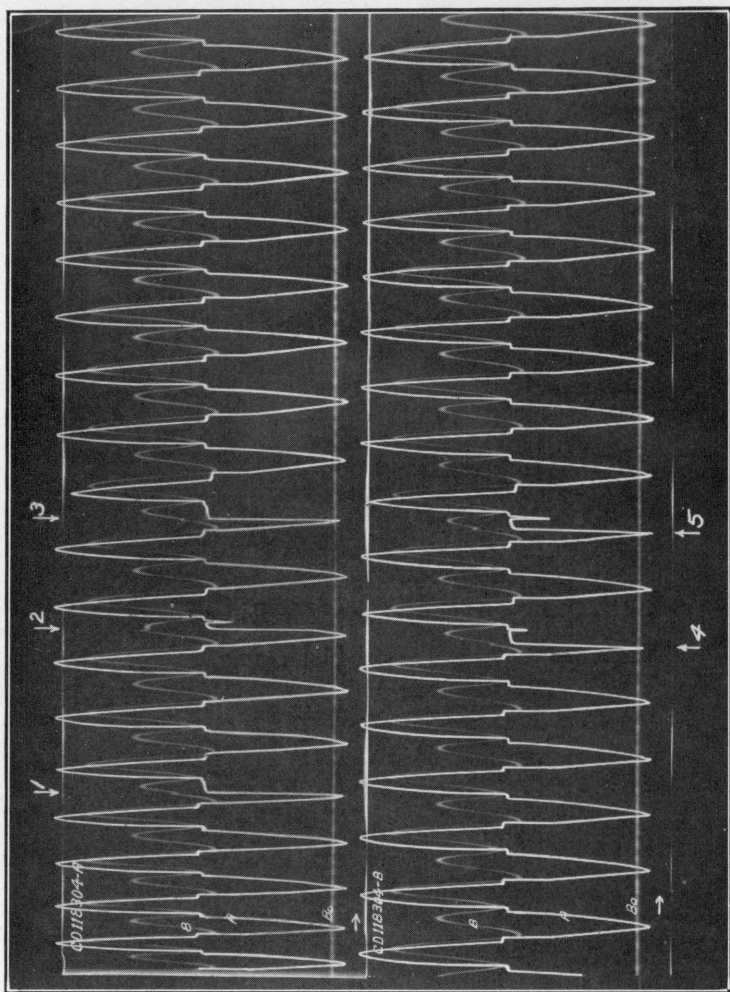

FIGURE 35.—Oscillogram showing arc-back of a 20-ampere tube with bent arms. Arc-back produced by gradually increasing load. Output just before arc-back was 655 volts and 24.75 amperes, direct current. Trace *A* shows voltage between anodes and trace *B* shows output current. Small arrows with numbers indicate points where failure occurred.

The normal anode current passes through these “protective tubes” without difficulty, and the inverse current is passed by the shunt resistances with a drop of only a few volts. The tube under test is, therefore, stressed the same as if

the additional tubes and resistances were not present. When the breakdown occurs, however, the current which flows is limited and the tube can, therefore, be left running for a few seconds with only moderate risk of being damaged.

In figure 35 one trace represents the voltage between the anodes and the other indicates the output current. Break-down occurred five times in the section of film shown as

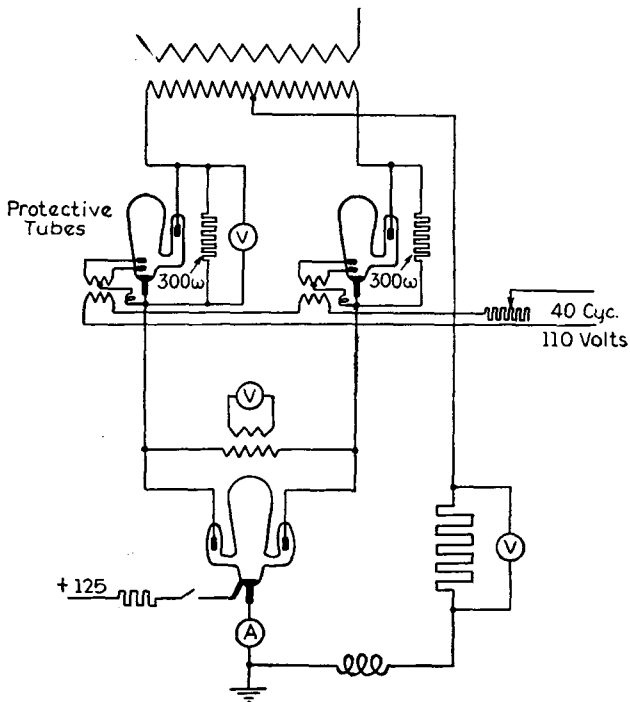

FIGURE 36.—Circuit used in investigating arc-backs.

indicated by the arrows. In each case, failure occurred at or near the time when the inverse voltage applied was a maximum. Following breakdown, the voltage across the tube was very small, the transformer voltage being absorbed by the resistances in the anode lines. When the point in the cycle was approached at which the transformer voltage became zero, the arc-back ceased and normal operation was resumed. Because of the protective apparatus, the arc-

backs had very little effect on the load current. The ripple in this current is due to insufficient choke action.

In some cases, arc-back was found to occur every cycle, in other cases it would occur occasionally and at times an anode would break down every cycle for ten or twelve cycles and then operate without failure for a period. With loads only slightly in excess of that required to cause arc-back, the failure always occurred when the inverse voltage was a maximum except in some cases where breakdown on the previous cycle had left traces of gas resulting in failure at a lower voltage.

This makes it almost impossible to connect arc-back with punishment of the anodes by positive-ion bombardment for this punishment was not the most severe at the time of failure but at a previous point in the cycle. If, however, arc-back involves an insulation breakdown, it would be expected that with a gradually increasing load the failure would occur as shown by the oscillograms.

Breakdown of Mercury Vapor.

The breakdown of mercury vapor was investigated by means of the special tube shown in figure 37. This tube was constructed to run in a vertical position. One electrode consisted of the mercury pool at the bottom and the other consisted of a carbon button. The latter was fastened to an iron plunger which could be moved up and down or held in position by means of a solenoid outside the tube. The moving system consisted of the carbon button, the iron plunger, the rod by which they were connected, a lava ring behind the carbon button to keep it from touching the glass, and a coiled wire through which current was fed to the carbon electrode. The carbon button was made as large as possible without touching the glass, and flat metal disks having holes in their centers were slipped over the outside of the tube and placed in the planes of the mercury surface and lower surface of the button. These disks were then connected to the mercury and carbon, respectively, resulting in a nearly uniform electric field.

No arc was carried while the experiments were being made, but a small bulb was provided at the upper limit of travel of the carbon button so that it might carry a current when the tube was being exhausted. The apparatus was so arranged that the lower section of the tube could be kept at a definite temperature by means of oil in which it was submerged. The oil level was kept above the small spherical bulb in order that condensation might not occur and lower the vapor pressure below that corresponding to the oil temperature.

In making the breakdown tests, the voltage was obtained from an 11,000-volt "potential" transformer which was supplied with variable voltage on the low-tension side. The high-tension side was connected to the tube through a resistance of 300,000 ohms. When direct current was desired, a 0.06-microfarad condenser was connected to the transformer winding through a small kenotron rectifier. This condenser charged up to a potential equal to the peak value of the alternating voltage when no current was drawn and small currents could be drawn without causing a

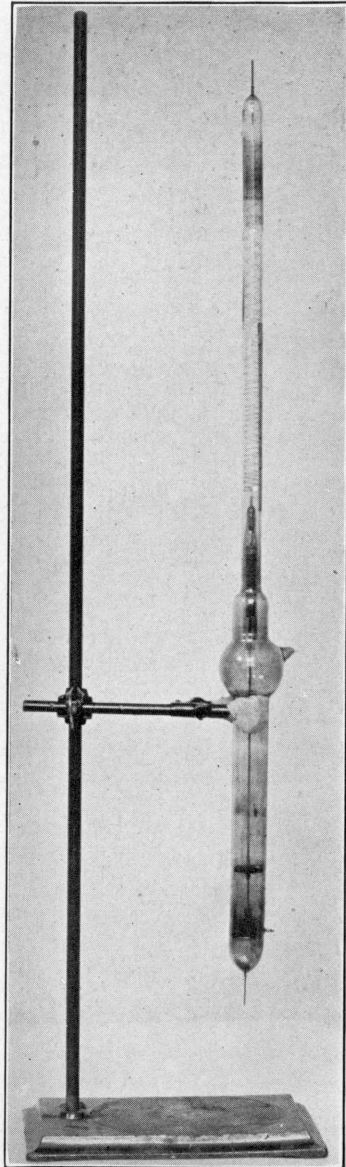

FIGURE 37.—Tube with movable electrode used in measuring breakdown of mercury vapor.

serious fluctuation in voltage. The high resistance was used with both the direct and alternating voltages. Its purpose was to limit the current after breakdown. Direct- and alternating-current milliammeters placed in series with the tube indicated the current through it. Currents of several milliamperes were usually obtained before failure. As it was not thought desirable to pass the current for the

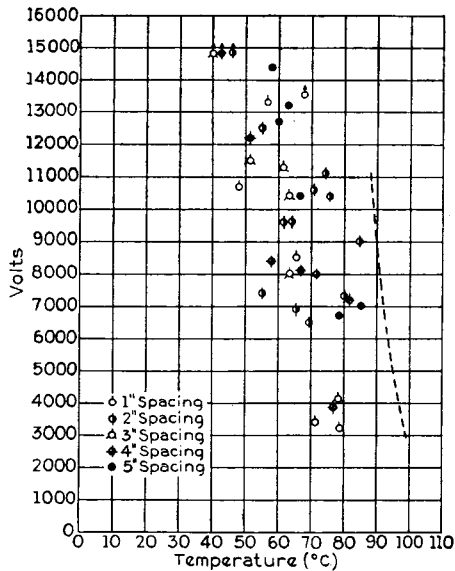

FIGURE 38.—Breakdown voltages (alternating) for special tube with movable electrode and shields to give a uniform electric field. The dotted curve is from figure 40 with the voltage multiplied by $\frac{1}{\sqrt{2}}$. Arrows indicate voltages applied without causing breakdown.

high-tension voltmeter through the limiting resistance, this voltage was measured at the source. With a direct voltage applied to the tube, the drop in the current-limiting resistance before failure could be deducted from the voltmeter reading. With an alternating voltage this error had to be neglected.

The first data obtained are shown in figure 38. With electrode spacings varying between 1 and 5 inches and an alternating applied voltage, no variation in the potential

required to produce breakdown can be determined as due to a change in the distance between electrodes. Instead, the entire variation appears to be due to changes in temperature. This is probably due in part to the large experimental errors involved which would effectively mask any small variation, but the apparent complete independence is surprising.

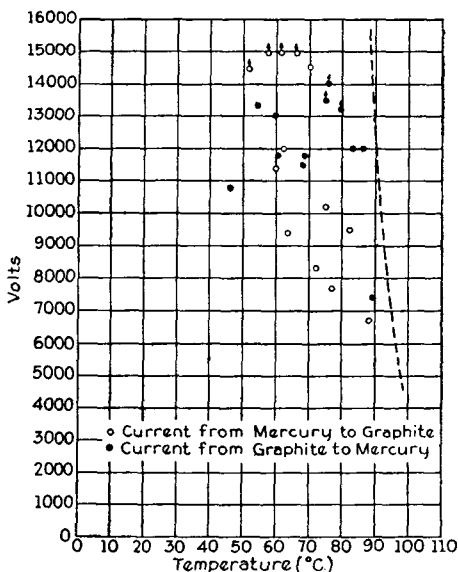

FIGURE 39.—Breakdown voltages (direct) for special tube with movable electrode and shields. Electrode spacing, 4 inches. The dotted curve is from figure 40. Arrows indicate voltages applied without causing breakdown.

If voltage and temperature are to be connected by one curve, the question arises as to where it should be drawn. In this case, there can be no doubt that it should pass through the highest observed values for the lower values are due to some transient condition of the electrode surfaces or foreign gases in the vapor which cause breakdown at lower voltages and are often "cleaned up" by the resulting arc. This phenomenon corresponds to the "flashing" in the standard rectifiers which is very erratic, occurs below the arc-back voltage, and normally causes no serious trouble. The dotted curve, shown in figure 38, was

obtained from data on some other widely different tubes, but it is suspected that this curve should also hold in the case under consideration. Two small errors are involved in this set of readings. First, no correction has been made for the drop in the current-limiting resistance and, second, no allowance has been made for the heating effect of the current before breakdown.

Figure 39 shows the data obtained with the movable electrode tube holding the spacing at 4 inches and using a direct voltage applied in either direction. These points have been corrected for the drop in the current-limiting resistance. The errors due to the presence of gas are very noticeable, as the values obtained at different times do not agree. It appears to make no appreciable difference whether the current flow is from the graphite to the mercury or in the opposite direction. The dotted curve is from the same data as that shown in figure 38.

Breakdown Voltage is Nearly Independent of Electrode Shapes or Spacings or Presence of Ionization.

In order to check the lack of independence of the breakdown voltage upon the spacing, measurements were made on a number of tubes with a variety of electrode arrangements. Figure 40 shows the results. With only a few exceptions, which might readily be attributed to the presence of gas, all the points fall very close to a single line. This line is the basis of the curves shown in figures 38 and 39 and is also drawn in figure 41.

Figure 41 indicates the effect of a current carried by a second anode upon the breakdown voltage of the first. No appreciable difference is noted, and rough calculations show that the heating effect of the arc should increase the temperature of the vapor only a few degrees above that of the oil.

Most investigators of gas-discharge phenomena have studied fixed gases such as air, hydrogen, and oxygen. Their results show a decided increase in breakdown potentials for small electrode spacing when the pressure is below

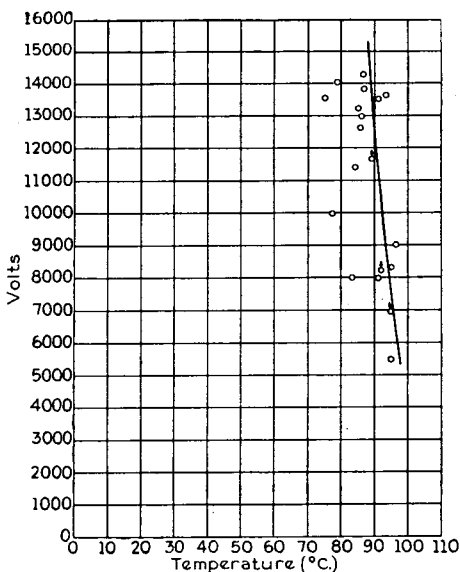

FIGURE 40.—Breakdown voltages (direct) for various rectifier tubes. Mercury, positive; graphite, negative. No current to other electrodes. Arrows indicate voltages applied without causing breakdown. Data are from twelve tubes of seven different designs.

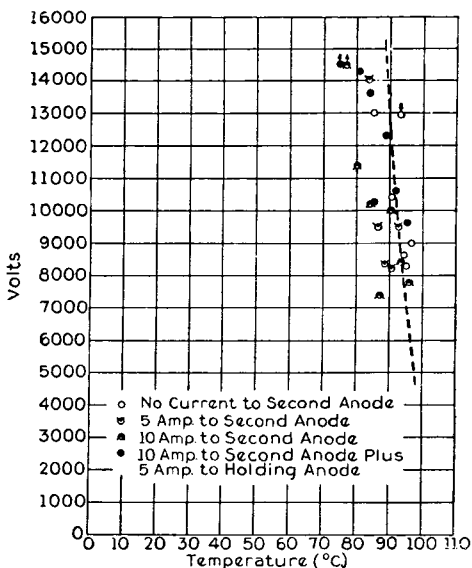

FIGURE 41.—Breakdown voltages for a special, bent arm, 20-ampere tube. Arrows indicate voltages applied without causing breakdown. The dotted curve is from figure 40.

a certain critical value.¹ The foregoing tests with mercury vapor show that such an effect, if present, is much less marked, at least in the range occurring in glass mercury arc rectifiers. Further light can be shed on the problem by making breakdown measurements at high temperatures. At present all that is known is that the curves obtained will resemble figure 42 and that beyond the point of minimum voltage there is very little current carried before breakdown, a reflection of a change in the mechanism of the failure.

Prediction of Arc-back Voltage.

If the data shown in a rough form by figure 42 are of any value, it should be possible to predict the arc-back voltage of a tube by measuring its temperature while

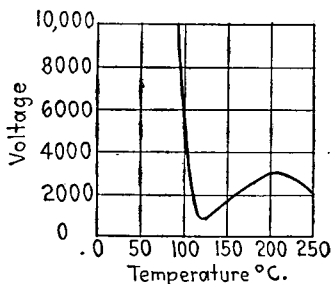

FIGURE 42.—General form of breakdown curves.

carrying current at low voltage, and picking the arc-back voltage corresponding to that temperature from figure 42. The procedure is, of course, complicated by the facts that a tube under operating conditions will not be at a uniform temperature; that the mercury vapor may not be in a saturated state; and that foreign gases may have the ability to disturb conditions. The agreement obtained in several cases which have been investigated, however, indicates that this should be a very fruitful field of investigation.

¹ J. J. THOMSON, "Conduction of Electricity Through Gases."

PART II
POWER RECTIFIER CIRCUITS

CHAPTER VII

FUNDAMENTAL WAVE SHAPES OF RECTIFIERS, IDEAL CASES WITH IMPEDANCELESS TRANSFORMERS

A study of rectifier circuits is primarily a study of wave forms. Unlike rotating apparatus, a rectifier stores no energy within itself, so that there is a constant connection between the currents and voltages on the alternating-current side and the current and voltage on the direct-current side. The question of rectifier-circuit calculations, like most circuit calculations, is, in the last analysis, a matter of establishing the proper equivalent circuit. In doing this, the indispensable thing is an accurate physical conception of what occurs in both the rectifier and the circuits. This chapter will be devoted to the discussion of some of the fundamental and simpler wave forms of rectifiers and the resulting voltage ratios and heating effects of the currents. Later chapters will then discuss the more elaborate phenomena of regulation and allied problems as though caused by deviations from the simpler wave forms.

For the purpose of circuit calculation, the rectifier may be regarded as a simple electrical check valve. Current flows readily in one direction, but not in the other. This applies to the total current only. Any sort of alternating current may be superimposed on a direct current passing through a rectifier, and such alternating current will be in no way affected by the valve action so long as there is always some net current flowing in the direction to keep the valve open. Practically, this means that, if, for any reason such as the transfer of current from one anode to another, current is momentarily flowing from two anodes simultaneously, those two anodes may be considered as tied together by a metallic connection until one or the other shall pass to zero current. The application of this manner

of thought will become clearer as the behavior of the different equivalent circuits is considered.

Single-phase Rectifier without Direct-current Choke.

Figure 43a shows a single-phase rectifier circuit in which the transformer windings t_0 , t_1 , and t_2 are supposed to have no resistance or leakage reactance, and the remainder of

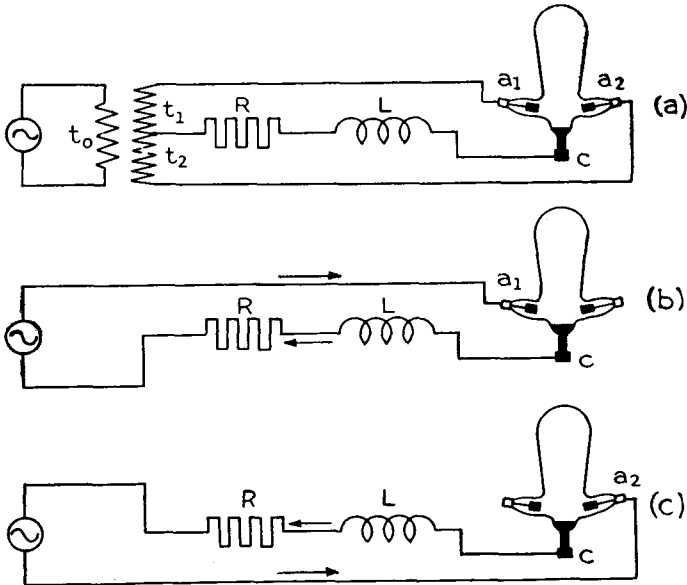

FIGURE 43a, b, and c.—Single-phase rectifier circuit without choke, and equivalent circuits.

the circuit is also without series impedance except for the load resistance R . The transformer is supposed to have no exciting current and each of the transformer windings (t_0 , t_1 , and t_2) is to contain the same number of turns. Suppose that for values of θ between 0 and π the phase is such that a_1 is positive. The equivalent circuit can then be drawn as in figure 43b. If e_1 is equal to $\sqrt{2}E \sin \theta$ for this period, then $i_R = \sqrt{2} \frac{E}{R} \sin \theta$. In the interval $\pi < \theta <$

2π the potential of a_1 is negative with respect to the cathode c , so that no current can flow, but a_2 is now positive so

that current will flow in the equivalent circuit shown in figure 43c. During this period, $e_2 = -\sqrt{2}E \sin \theta$ and $i_R = -\sqrt{2}\frac{E}{R} \sin \theta$. Since $\sin \theta$ is negative during the second period, i_R is in the same direction as before and rectification has been obtained. The only drop in the active part of the

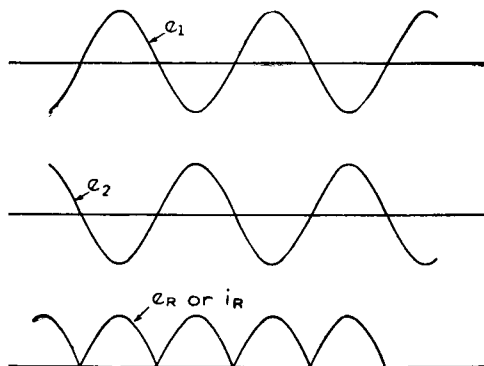

FIGURE 44.—Wave shapes obtained with circuit shown in figure 43.

circuit is in the resistance R , and the current and voltage are then proportional and in phase. Figure 44 shows the shapes of the voltage and current waves obtained.

Single-phase Rectifier with Direct-current Choke.

Rectifiers with large variations in their output current and voltage waves have limited applications although very desirable where it is possible to use them because of their simplicity and cheapness. For most power uses, however, a fairly continuous direct current is required. To secure such a current, a large inductance may be connected in series with the load resistance. The circuit then becomes the one shown in figure 45a. As in figure 43a, the turns in the windings t_0 , t_1 , and t_2 are equal in number, the transformer is assumed to have no exciting current, and there is no impedance except the load resistance R and inductance L .

If the inductance L is very large, the current through it will remain substantially constant throughout a cycle.

The equivalent diagrams of figures 43b and 43c now become those of figures 45b and 45c. The impedance of both these circuits to alternating current is very high, so that no appreciable amount will flow in the part containing R and L . As shown by the arrows, however, there are components of electromotive force in the same direction through R and L in both circuits. Current flows accordingly and

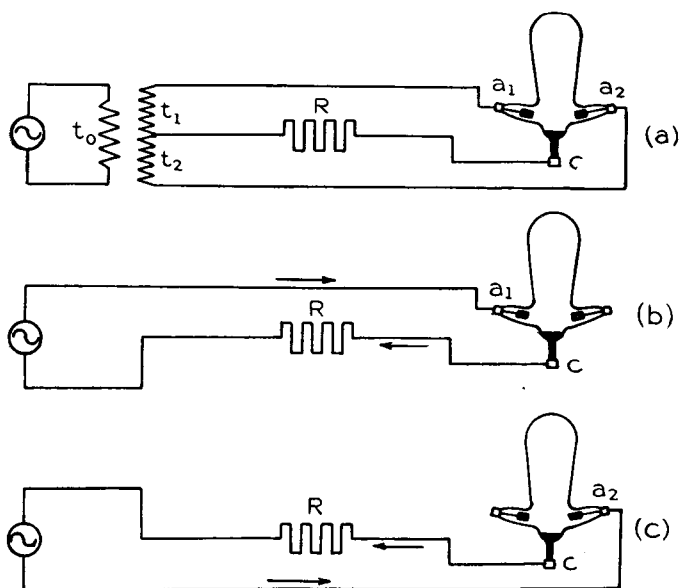

FIGURES 45a, b, and c.—Single-phase rectifier circuit with choke, and equivalent circuits.

is proportional to the average impressed potential. Designating the voltage of t_1 by $\sqrt{2}E \sin \theta$, the current will flow through the circuit of figure 45b while $0 < \theta < \pi$, and through the circuit of figure 45c while $\pi < \theta < 2\pi$. The currents and voltages for the whole circuit are shown in figure 46.

Since a continuous current flows in R and L , and this current flows to anode a_1 while it is positive and to anode a_2 while it is positive, the individual anode current is in the form of square blocks. While current flows from either anode, the potential across R and L is that induced in

the corresponding secondary winding. This gives a series of sinusoidal potential loops all in one direction, alternate loops being due to the same anode. Since the current does not vary, the voltage drop in the resistance will not vary. On the other hand, no permanent difference of potential can exist across an inductance, so that the variable voltage across L and R must have equal areas on both sides of an

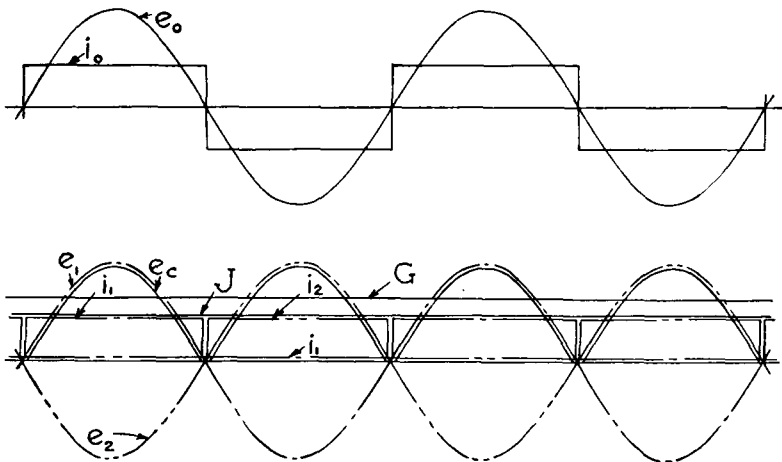

FIGURE 46.—Wave shapes obtained with circuit shown in figure 45.

axis representing the average output voltage. The steady component will appear across R while the ripple will appear across L .

Three-phase Rectifier.

The single-phase rectifier has a very irregular voltage wave and, therefore, requires a very large inductance L to keep the current sensibly constant. Polyphase rectifiers are much better in this respect. Figure 47 shows the connections of a simple three-phase rectifier corresponding to the single-phase rectifier of figure 45. Each of the anodes a_1 , a_2 , and a_3 has a sinusoidal electromotive force impressed upon it. Current flows from the one which is most positive at any instant. Thus, one anode will be

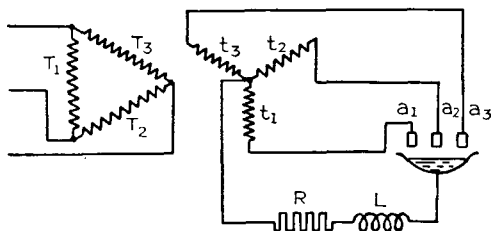

FIGURE 47.—Three-phase rectifier circuit.

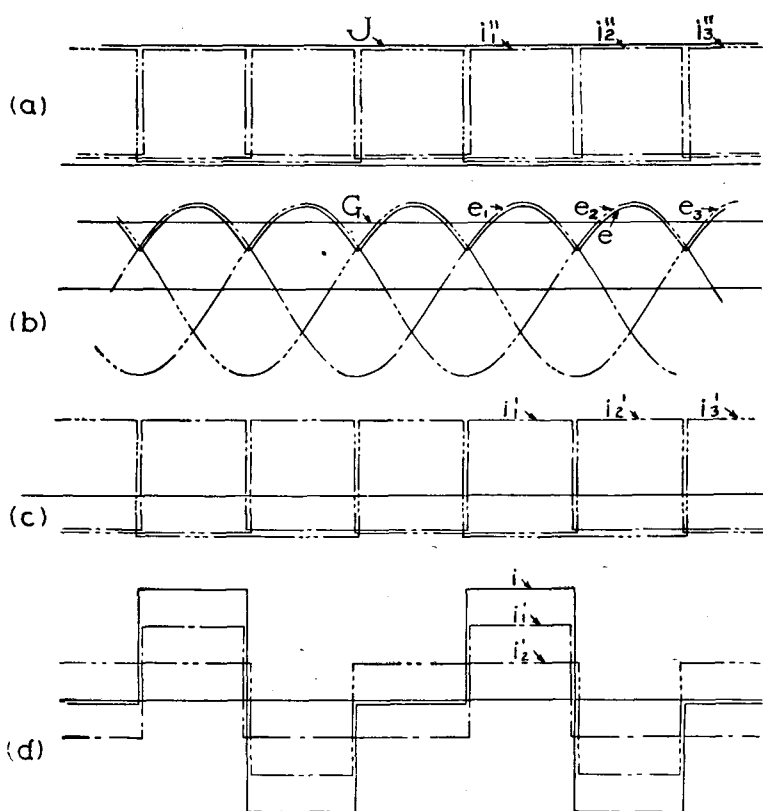

FIGURE 48a, b, c, and d.—Wave shapes of three-phase rectifier circuit shown in figure 47. a. i_1'' , i_2'' , and i_3'' are the currents in the secondary windings. J is the load current. b. e_1 , e_2 , and e_3 are the voltages communicated to the anodes. e is the cathode potential and G is the output voltage. c. i_1' , i_2' , and i_3' are the transformer primary currents. d. i is the current in one supply line.

the most positive for one-third of the time, and, during that time, carries the entire current, which, as before, is held constant by the inductance L . Figure 48 gives the wave shapes of the various voltages and currents. The transformer primary currents are the same as those in the secondary except that the direct-current component is absent.

Output Voltage of Rectifiers.

Other numbers of phases can be used such as two, four, six, or twelve. If the number of phases be designated by the number of secondary windings uniformly distributed

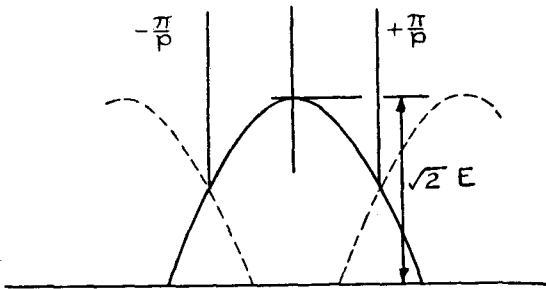

FIGURE 49.

with respect to the angular displacements of their voltages, it is possible to derive a simple expression giving the output voltage for a rectifier of any number of phases p . With this notation p will be 2 for the single-phase rectifier shown in figure 45a. Current will flow in any particular phase for the period $\frac{2\pi}{p}$ and during this time is held constant by the direct-current choke. Throughout this period, the cathode potential follows that of the anode carrying current. The output direct voltage is, therefore, the average of a sine wave for the period $\frac{2\pi}{p}$, the maximum of the wave occurring in the middle of the period as shown in figure 49.

For any number of phases, the average direct potential G is given by the equation

$$\begin{aligned} G &= \sqrt{2}E \frac{p}{2\pi} \int_{-\frac{\pi}{p}}^{+\frac{\pi}{p}} \cos \theta d\theta, \\ &= \sqrt{2}E \frac{p}{\pi} \sin \frac{\pi}{p}. \end{aligned} \quad (6)$$

Ripple in Output Voltage.

It has been assumed that L will be so large that no appreciable current change will take place. In practical applications, however, it will be found that ripples not exceeding a certain magnitude, depending on the service, are not particularly undesirable, and reasons of economy will prevent the use of a larger choke than is necessary.

The current ripple is caused by a voltage which has an instantaneous value equal to the difference between the rectified portions of sine waves and the steady direct potential. A knowledge of this ripple voltage will, therefore, be of help in designing a suitable choke. It can be readily analyzed in the form of a Fourier series. By measuring the angular displacements from the peak of the instantaneous rectified voltage wave, the ripple voltage will be symmetrical and the resulting series will contain only cosine terms which will have coefficients given by the expression

$$\begin{aligned} a_n &= 2 \frac{p}{2\pi} \int_{-\frac{\pi}{p}}^{+\frac{\pi}{p}} \sqrt{2}E \cos \theta \cos n\theta d\theta, \\ &= \frac{\sqrt{2}Ep}{\pi} \left[\frac{\sin (n-1)\theta}{2(n-1)} + \frac{\sin (n+1)\theta}{2(n+1)} \right]_{-\frac{\pi}{p}}^{+\frac{\pi}{p}}, \\ &= \frac{\sqrt{2}Ep}{\pi} \left[\frac{\sin (n-1)\pi/p}{(n-1)} + \frac{\sin (n+1)\pi/p}{(n+1)} \right], \\ &= \frac{\sqrt{2}Ep}{\pi(n^2-1)} \left[2n \sin \frac{n\pi}{p} \cos \frac{\pi}{p} - 2 \cos \frac{n\pi}{p} \sin \frac{\pi}{p} \right], \end{aligned}$$

There can be no values for n less than p , however, because the ripple voltage repeats itself p times per cycle of the

secondary voltages, and it is expressed in terms of the frequency of the latter. For the same reason, there can be no values of n which are fractional multiples of p .

Therefore, $n = mp$ where m is an integer and

$$n \sin \frac{n\pi}{p} \cos \frac{\pi}{p} = mp \sin m\pi \cos \frac{\pi}{p},$$

and, as $\sin m\pi = 0$, the first term inside the brackets disappears. For the second term

$$- \cos \frac{n\pi}{p} \sin \frac{\pi}{p} = - \cos m\pi \sin \frac{\pi}{p} = \pm \sin \frac{\pi}{p},$$

so that

$$a_n = \frac{\pm 2\sqrt{2}Ep \sin \pi/p}{\pi(n^2-1)} = \frac{\pm 2G}{(n^2-1)} \tag{7}$$

which is plus for odd values of m and minus for even values. This relation gives the maxima of all the harmonic voltages expressed as fractions of the direct potential. Knowing the components of the voltage tending to produce the variations in the output current, it is a simple matter to calculate the variation in current which will result from any smoothing inductance.

Tables of Voltage Ratios.

Table II, calculated from equation (6) gives the values of the average direct voltage for various rectifier combina-

TABLE II
RECTIFIER OUTPUT VOLTAGE

Phases	Ratio of average to alternating maximum	Ratio of average to alternating root mean square
Single phase (two anodes).....	0.636	0.900
Three phase (three anodes).....	0.827	1.170
Quarter phase (four anodes).....	0.900	1.273
Six phase (six anodes).....	0.955	1.350
Infinite phases.....	1.000	1.41

tions, and Table III gives the voltage pulsations for the lowest three frequencies in terms of the output direct voltage G as calculated from equation (7). The first column of figures in the latter table is the value of the lowest frequency present in each case as a multiple of the fundamental frequency.

TABLE III
OUTPUT VOLTAGE PULSATIONS

Phases	Least frequency	Amplitudes (peak) of first three components		
		1	2	3
Single phase (two anodes).....	2	0.667 <i>G</i>	0.133 <i>G</i>	0.057 <i>G</i>
Three phase (three anodes).....	3	0.250 <i>G</i>	0.057 <i>G</i>	0.025 <i>G</i>
Quarter phase (four anodes).....	4	0.133 <i>G</i>	0.032 <i>G</i>	0.014 <i>G</i>
Six phase (six anodes).....	6	0.057 <i>G</i>	0.014 <i>G</i>	0.006 <i>G</i>

As an example of the use of these tables, suppose it is desired to determine the alternating voltage required to give a 220-volt direct potential. A single-phase rectifier with a 15-volt arc-drop is to be used. The required voltage of the secondaries (anodes to neutral) is

$$\frac{220 + 15}{0.900} = 261 \text{ volts root mean square.}$$

Furthermore, let it be supposed that the output current of 100 amperes is to be fed into a pure counter electromotive force load such as a storage battery and that a current pulsation of ± 1 per cent is permissible at the lowest or 120-cycle ripple frequency. This component of the ripple voltage has a maximum value of

$$(220 + 15) \times 0.667 = 157 \text{ volts,}$$

and the maximum value of the current due to it is 1 ampere. Hence, a 157-ohm reactance is required in the choke which corresponds to an inductance of $\frac{157}{2\pi \times 120} = 0.21$ henry.

The ripple of next higher frequency is at 240 cycles so that it is opposed by an impedance of 314 ohms. Its maximum value is 235×0.133 , or 31.2 volts, and the current due to it has, therefore, only 0.1-ampere maximum value. It is apparent that the component of ripple current having the lowest frequency is much the largest and that, if it is held within satisfactory bounds, the other components may usually be safely neglected. It also appears that rectifiers with a large number of phases gain not only by the smaller magnitude of the ripple voltage obtained, but also by its increased frequency.

Current Waves.

A knowledge of the voltages in a rectifier circuit makes it possible to provide transformers of the proper ratio and chokes of suitable rating for any particular application.

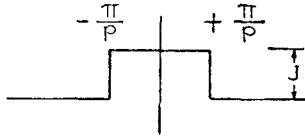

FIGURE 50.

Nothing has yet been said about the load on the transformers, however. This is determined by a consideration of the current waves. In the ideal cases considered in this chapter, the current flows in the form of square blocks of which an analysis is readily made. In practical applications, the wave form will usually be found to resemble closely that of the ideal case, for the factors which produce variations from this shape also cause a loss in output voltage or ripples in the output current and neither of these can be allowed to become very large.

If p be the number of anodes, each may be considered to carry current during an angle represented by the interval from $-\frac{\pi}{p}$ to $+\frac{\pi}{p}$, as shown in figure 50. With this arrangement the wave may be analyzed into a series of

cosine terms because of its symmetry. The amplitude of the n th harmonic is then

$$\begin{aligned}
 a_n &= \frac{1}{\pi} \int_{-\frac{\pi}{p}}^{+\frac{\pi}{p}} J \cos n\theta d\theta, \\
 &= \frac{J}{n\pi} [\sin n\theta]_{-\frac{\pi}{p}}^{+\frac{\pi}{p}} = \frac{2J}{n\pi} \sin \frac{n\pi}{p}.
 \end{aligned}
 \tag{8}$$

Of even greater interest are the average and root-mean-square values of the current. The former is, of course, $\frac{J}{p}$ and the latter $\frac{J}{\sqrt{p}}$. The properties of square waves obtained with various numbers of phases are shown in Table IV. Average and root-mean-square values of the

TABLE IV
HARMONIC COMPOSITION OF SQUARE ANODE-CURRENT WAVES

Phases (number of anodes).....	2	3	4	6
Average value.....	0.500J	0.333J	0.250J	0.167J
Root-mean-square value.....	0.707J	0.577J	0.500J	0.408J
Fundamental (amplitude).....	0.637J	0.552J	0.450J	0.318J
Second harmonic (amplitude).....	0.0	0.276	0.318	0.276
Third harmonic.....	0.212	0.00	0.150	0.212
Fourth harmonic.....	0.0	0.138	0.0	0.138
Fifth harmonic.....	0.127	0.110	0.090	0.064
Sixth harmonic.....	0.0	0.0	0.106	0.0
Seventh harmonic.....	0.091	0.079	0.064	0.045
$J\sqrt{1 - \frac{1}{p^2}}$	0.500J	0.471J	0.433J	0.373J

complete wave are given in the first two lines, and the amplitudes of the alternating components of different frequencies follow below. The last line gives the root-mean-square value of the sum of all the alternating components $J\sqrt{1 - \frac{1}{p^2}}$.

Heating of Transformers for Rectifier Service.

Since the average and root-mean-square values of all the currents and voltages in the simple rectifiers have now been determined, it is an easy matter to calculate the transformer output and losses for specific cases and compare them with the performance obtained with an ordinary alternating-current load. Instead of doing this, however, it is interesting to indulge in a longer discussion which will indicate more clearly the desirability of some of the popular rectifier circuits.

Figure 51 indicates the sinusoidal voltage and square secondary-current waves of a rectifier of any number of phases. Let it be assumed that the voltage wave has an amplitude of $\sqrt{2}E$ and that the current wave has an amplitude varying with the angle 2θ in such a manner that the heating caused by it will be constant. This means that the average value of the current will be

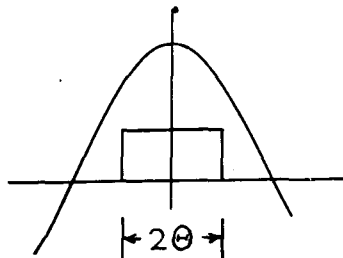

FIGURE 51.

greatest when the angle 2θ is equal to 2π and that it will decrease as θ decreases. On the other hand, the average voltage during the conducting period will become greater as θ is decreased, and the greatest output will be obtained at a value of θ which allows a large average current to flow and still takes advantage of the higher voltage obtained when the angle is not too great.

The output per secondary phase will be $\frac{2\theta GJ}{2\pi}$. By substituting θ for $\frac{\pi}{p}$ in equation (6), there results

$$G = \frac{\sqrt{2}E}{\theta} \sin \theta,$$

and the output per phase is thus

$$W_{a.c.} = \frac{\sqrt{2}EJ \sin \theta}{\pi} \tag{9}$$

The loss per secondary phase will be $\frac{J^2 R \theta}{\pi}$ and, if $W_{a.c.}$ is the alternating-current load resulting in the same loss,

$$\left(\frac{W_{a.c.}}{E}\right)^2 R = \frac{J^2 R \theta}{\pi}$$

Taking the ratio of these two powers gives

$$\frac{W_{d.c.}}{W_{a.c.}} = \sqrt{\frac{2}{\pi}} \frac{\sin \theta}{\theta^3} \tag{10}$$

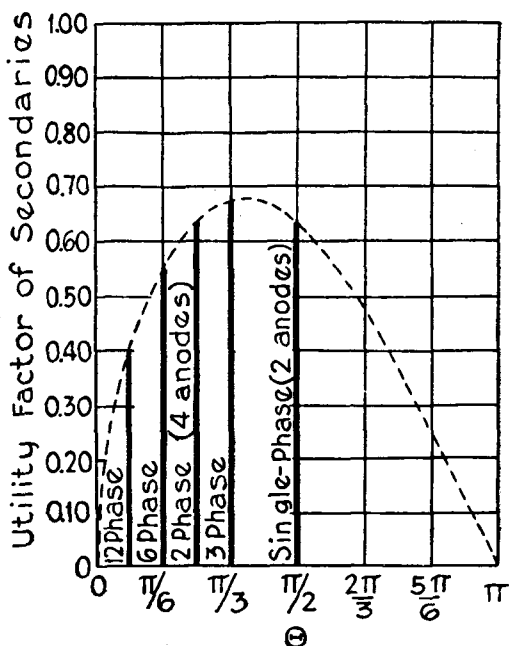

FIGURE 52.—Utilization of secondary windings as a function of the angle during which current passes.

Figure 52 shows the relation graphically. The maximum output is obtained when θ is 66 degrees 48 minutes, corresponding to 2.69 phases. Actual rectifiers, of course, can have values of θ equal only to $\frac{\pi}{p}$ where p will be a whole number. The heavy vertical lines represent the performance of such rectifiers, and it appears that the three-phase rectifier gives the greatest output while the two-phase

(four anodes) and single-phase (two anodes) rectifiers are almost as good. By substituting $\frac{\pi}{p}$ for θ in equation (10), there results

$$\frac{W_{\text{d.c.}}}{W_{\text{a.c.}}} = \frac{\sqrt{2p}}{\pi} \sin \frac{\pi}{p}. \quad (11)$$

The primary windings will not be submitted to so severe heating as the secondaries, for the direct component of the secondary currents will not have to be carried by the primaries. In order to avoid saturation of the transformer cores by the direct currents carried by the secondaries, it is customary where the total number of anodes is even to have one primary winding feed two secondary windings. Under these conditions, the primaries carry square blocks of current similar to those in the secondaries but only 180 degrees apart and having alternate blocks of opposite sign. The heating effect of such a current will be twice that of a current consisting of only the pulses in one direction, and its root-mean-square value will, therefore, be $\sqrt{2}$ times that of the latter current. The inputs represented by the two currents will be in the ratio of two to one, however. Hence the primary winding of a transformer for rectifier service need have only $\frac{1}{\sqrt{2}}$ times the rating of the two secondaries which it supplies. With such design, the primary winding is able to carry an alternating-current load only $\sqrt{2}$ times as great as the load which either secondary could carry, and yet the load carried as part of a rectifier is twice that of either secondary. Hence, the primary windings are utilized to $\sqrt{2}$ times the extent that the secondaries are used as indicated in figure 52 or equation (11), and it is interesting to notice that for the double three-phase case the primary windings will be almost as effectively utilized as though they carried a sine-wave alternating current. This circuit employs two three-phase rectifiers in series or parallel in order that two secondary phases 180 degrees apart may be supplied from a single primary.

Power Factor.

In the ideal cases considered in this chapter, power factor will be the same as the utility factor, for both represent the ratio of actual power to power which could be carried at unity power factor with a sine wave of current of the same root-mean-square value as the wave actually obtained.

The conception of utility factor as distinct from power factor has two important advantages, however. In the first place, it distinguishes the phenomena involved from a mere displacement in phase of sine waves, which is very important. Secondly, it can be defined in such a way that it represents a different and useful quantity. Consider a case where reactive drops affect the voltage. By defining the utility factor as the ratio of the product of the output current and open-circuit output voltage to the alternating volt-amperes giving the same heating, a term is introduced which is very useful in calculating the size of the transformers required. When no reactive drops occur, as in the ideal cases considered in this chapter, this definition will give a value of utility factor equal to the power factor.

The power factor of each transformer primary, then, under ideal conditions is $\sqrt{2}$ times the utility factor of its secondaries or

$$\text{P.F.} = \frac{2\sqrt{p}}{\pi} \sin \frac{\pi}{p}. \quad (12)$$

For a polyphase network carrying sine-wave currents of equal magnitude, the power factor of the group will be the power factor of the individual windings. A polyphase group of primary windings in a rectifier may have a better power factor than that of the individual windings, however, for many of the harmonic components of the current may circulate about the network and need be supplied by the power source only in part or not at all. It is apparent, then, that the primary currents of a rectifier cannot be treated by considering them sine waves with a displacement from the corresponding voltages. In particular, the wattless input to a rectifier cannot be algebraically added to the

wattless input to reactive machinery, for all the harmonic components must be added at right angles. That is, the wattless currents of all frequencies are effective in producing resistance losses only as the square root of the sum of their squares. Rectifiers added to a feeder carrying any considerable amount of reactive power for rotating machinery, therefore, improve its power factor, for the true power adds directly to that already carried, while the reactive power, being largely harmonics, makes no appreciable addition to the reactive power already carried.

Table of Rectifier Characteristics.

Tables *Va* and *b* show a number of rectifier circuits and give their performance under ideal conditions, *i.e.*, no resistance losses and no leakage reactance in the transformers. Table *Vc* shows the regulation when reactance is present. Discussion of this will be deferred until the next chapter.

Some explanation is necessary regarding the connections following the six phase in the table. These circuits are intended to give high utility factors and small output voltage ripples in order to save transformer and choke material.

Double-Y Circuit.

This circuit is intended to give the highest possible utility factor. The six secondary windings used are arranged in two three-phase stars which operate in parallel. These secondaries are so connected that the two corresponding to any primary will have voltages 180 degrees apart, thus causing the primary to carry current in two pulses 180 degrees apart and in opposite directions.

Two inductances are used in the output circuit. One of these is an ordinary choke and holds the total output current constant. The other resembles an autotransformer with a midtap. The two three-phase units are connected to the ends of its winding and the load to the center. This insures that the output current will divide equally between

TABLE V_a

Circuit	Diagram	Secondary Current		Sec. Voltage to Neut.	Total Sec. VA. and Util. Factor	Primary Current Wave
		Wave Shape	r. m. s.			
Single-Phase			$J/\sqrt{2}$ 0.707J	$\frac{\pi G}{2\sqrt{2}}$ 1.11G	1.57 JG U.F. = 0.637	
Three-Phase			$J/\sqrt{3}$ 0.577J	$\frac{\sqrt{2}\pi G}{3\sqrt{3}}$ 0.855G	1.481 JG U.F. = 0.675	
Quarter-Phase			$J/2$ 0.500J	$\frac{\pi G}{4}$ 0.785G	1.57 JG U.F. = 0.637	
Six-Phase			$J/\sqrt{6}$ 0.408J	$\frac{\pi G}{3\sqrt{2}}$ 0.741G	1.814 JG U.F. = 0.552	
Double Y			$J/2\sqrt{3}$ 0.289J	$\frac{\sqrt{2}\pi G}{3\sqrt{3}}$ 0.855G	1.481 JG U.F. = 0.675	
Triple Single-Phase			$J/3\sqrt{2}$ 0.236J	$\frac{\pi G}{2\sqrt{2}}$ 1.11 G	1.57 JG U.F. = 0.637	
Y Star			$J/2\sqrt{3}$ 0.289J	$\frac{\sqrt{2}\pi G}{3\sqrt{3}}$ 0.855G	1.481 JG U.F. = 0.675	
Triple Star			$J/\sqrt{6}$ 0.408J	$\frac{\pi G}{3\sqrt{6}}$ 0.428G	1.79 JG U.F. = 0.559	
Y Star Tertiary	Same as Y Star with Addition of Tertiary Winding		$J/\sqrt{6}$ 0.408J	$\frac{\pi G}{3\sqrt{2}}$ 0.741G	1.814 JG U.F. = 0.552	

TABLE Vb

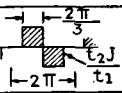
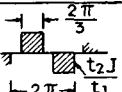
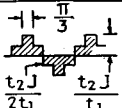
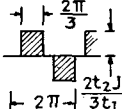
Effective Pri. Current & Pri. Volts	Total Pri. Volt-Amps & Utility Factor	Transformer Total V.A. & Utility Factor	Line Current Wave Form	Effective Line Current & Line Volts	Line V. A and Utility Factor	Principal Comp. of Choke or I.P.T. Voltage
$t_2/t_1 J$ $1.11 t_1/t_2 G$	1.11 JG U.F.=0.90	2.68 JG U.F.=0.746	Same as Primary	Same as Primary	U.F.=0.90	2 X freq. 0.471 G (r.m.s.)
$\frac{\sqrt{2} t_2 J}{3 t_1}$ $0.855 t_1/t_2 G$	1.209 JG U.F.=0.827	2.69 JG U.F.=0.743		$\frac{\sqrt{2} t_2 J}{\sqrt{3} t_1}$ $0.855 t_1/t_2 G$	1.209 JG U.F.=0.827	3 X freq. 0.1767 G (r.m.s.)
$\frac{t_2 J}{\sqrt{2} t_1}$ $0.785 t_1/t_2 G$	1.11 JG U.F.=0.90	2.68 JG U.F.=0.746	Same as Primary	Same as Primary	U.F.=0.90	4 X freq. 0.0943 G (r.m.s.)
$\frac{t_2 J}{\sqrt{3} t_1}$ $0.741 t_1/t_2 G$	1.283 JG U.F.=0.780	3.097 JG U.F.=0.646		$\frac{\sqrt{2} t_2 J}{\sqrt{3} t_1}$ $0.741 t_1/t_2 G$	1.047 JG U.F.=0.955	6 X freq. 0.0404 G (r.m.s.)
$\frac{t_2 J}{\sqrt{6} t_1}$ $0.855 t_1/t_2 G$	1.047 JG U.F.=0.955	2.528 JG U.F.=0.792		$\frac{t_2 J}{\sqrt{2} t_1}$ $0.855 t_1/t_2 G$	1.047 JG U.F.=0.955	I.P.T. 3 X f 0.1767 G per section Choke 6 X f 0.0404 G (r.m.s.)
$\frac{t_2 J}{3 t_1}$ $1.11 t_1/t_2 G$	1.11 JG U.F.=0.90	2.68 JG U.F.=0.746		$\frac{2\sqrt{2} t_2 J}{3\sqrt{3} t_1}$ $1.11 t_1/t_2 G$	1.047 JG U.F.=0.955	I.P.T. 2 X f. 0.471 G Per section Choke 6 X f 0.0404 G (r.m.s.)
$\frac{t_2 J}{\sqrt{6} t_1}$ $0.855 t_1/t_2 G$	1.047 JG U.F.=0.955	2.528 JG U.F.=0.792	Same as Primary	$\frac{t_2 J}{\sqrt{6} t_1}$ $1.482 t_1/t_2 G$	1.047 JG U.F.=0.955	6 X freq. 0.0404 G (r.m.s.)
$\frac{\sqrt{2} t_2 J}{\sqrt{3} t_1}$ $0.428 t_1/t_2 G$	1.047 JG U.F.=0.955	2.837 JG U.F.=0.705	Same as Primary	$\frac{\sqrt{2} t_2 J}{\sqrt{3} t_1}$ $0.741 t_1/t_2 G$	1.047 JG U.F.=0.955	6 X freq. 0.0404 G (r.m.s.)
$\frac{\sqrt{2} t_2 J}{3 t_1}$ $0.741 t_1/t_2 G$	1.047 JG U.F.=0.955		Same as Primary	$\frac{\sqrt{2} t_2 J}{3 t_1}$ $1.283 t_1/t_2 G$	1.047 JG U.F.=0.955	6 X freq. 0.0404 G (r.m.s.)

the two groups of windings and that the load cannot be shifted from one three-phase rectifier to the other, due to the inequalities in instantaneous voltage which result from the phase displacement of the voltages in the two groups. Because the direct-current flows in opposite directions in the two portions of the winding, this inductance will not become saturated and will, therefore, require only a small amount of material. It is usually designated "interphase transformer" on account of the manner in which it connects the groups of phases.

The interphase transformer will have impressed across it the instantaneous difference in potential between the two

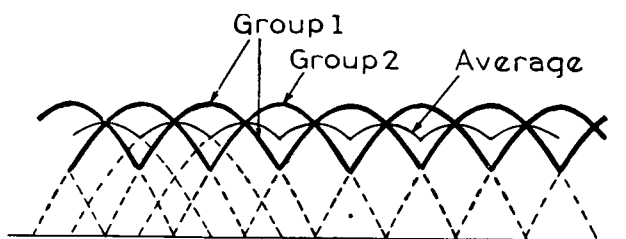

FIGURE 53.—Choke-system voltages in a double three-phase circuit.

groups of phases. In figure 53 the voltage of each group is shown by a heavy line. The interphase transformer absorbs the difference in potential and passes on to the load and choke the instantaneous average voltage. This average can be seen by inspection to be identical in form with the output wave of a six-phase rectifier, and the ripple in it will be removed by the choke.

The direct voltage applied to the load is, of course, equal to that of either three-phase group since the choke system can have no constant difference in potential across it. The value of the components of the six-phase ripple applied to the line choke can be determined from equation (7). The output voltage of each three-phase group contains some components which are held back by the interphase transformer and some which are passed on to the line choke, but the principal component which is at three times the frequency of the supply source appears across the interphase

TABLE Vc

Circuit	Initial slope of regulation curve, A (See Eq. 17 (b) p. 113)			Output voltage at end of initial straight line			Short-circuit current		
	Reactance in			Reactance in			Reactance in		
	Anode leads	Primary	Lines	Anode leads	Primary	Lines	Anode leads	Primary	Lines
Single phase.....	1	1	1	0	0	0	J_K	J_K	J_K
Three phase.....	$\sqrt{3}$	$\sqrt{3}$	$\sqrt{3}$	0.366 G_0	0.366 G_0	0.366 G_0	J_K	J_K	J_K
Quarter phase.....	$2\sqrt{2}$	$\sqrt{2}$	$\sqrt{2}$	0.62 G_0	0	0	J_K	0.707 J_K	0.707 J_K
Six phase.....	6	3	1	0.823 G_0	0.823 G_0	0.75 G_0	J_K	0.667 J_K	0.577 J_K
Double Y^1	$\sqrt{3}$	$\frac{\sqrt{3}}{2}$	$\sqrt{3}$	0.366 G_0	0.75 G_0	0.75 G_0	J_K	0.667 J_K	0.667 J_K
Triple single phase.....	1	1	2	0	0	0.75 G_0	J_K	J_K	0.866 J_K
Y star.....	$\sqrt{3}$	$\frac{\sqrt{3}}{2}$	$\sqrt{3}$	J_K
Triple star.....	6	4	4	J_K
Y star tertiary.....	6	3	3	0.823 G_0	0.75 G_0	0.75 G_0	J_K	0.577 J_K	0.577 J_K

¹ With either delta-connected primaries or Y -connected primaries and a tertiary winding.

transformer. Because of the displacement in phase of the secondaries, this triple-frequency component will be in opposite phase for the two groups and the voltage across the entire interphase transformer will be twice that corresponding to either group as given by equation (7).

The double-Y circuit is particularly economical because it not only uses the transformer to the best possible advantage, but it is also saving of choke material. Because no saturation takes place in it, the interphase transformer requires relatively little material and the line choke in which saturation does take place need have only small inductance because the voltage applied to it is not only of six times input frequency but also quite small in magnitude.

Triple Single Phase Circuit.

In the same manner that two three-phase rectifiers can be combined by the use of an interphase transformer,

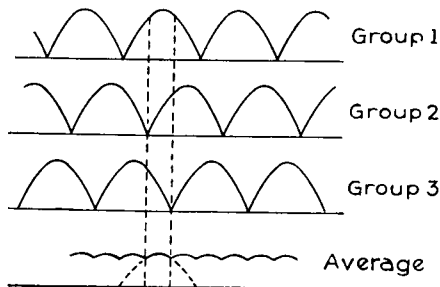

FIGURE 54.—Choke-system voltages in a triple single-phase circuit.

three single-phase rectifiers may be combined by using a three-phase interphase transformer. The direct voltage G and the various utility factors will be the same as for single phase, but the output voltage wave of the combination is the same shape as for six phase. That this is so may be seen by inspection of figure 54. Dividing the cycle into 60-degree intervals as shown, it will be found that the average instantaneous voltage repeats itself every 60 degrees and that the shape of the wave is the same as obtained with six-phase operation.

In this case, the interphase-transformer voltage wave is unsymmetrical and must, therefore, contain even harmonics, a result which may be confirmed by analyzing the potentials of the single-phase groups. The principal component of the interphase-transformer voltage will be that at double supply-line frequency, and the principal component of the choke voltage will be at six times line frequency. Both components may be calculated by equation (7).

Y-star Circuit.

The combination designated as Y star is of interest because it produces the same result as the double three phase but without the interphase transformer. To pass

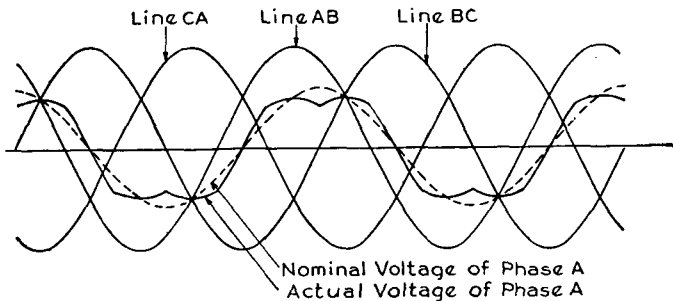

FIGURE 55.—Voltages in a Y-star circuit.

from one supply line to another, current must traverse the primaries of two phases. Except for relatively small exciting current, two corresponding secondary phases must carry an equivalent load current at the same time, and to do so the two anodes must be at the same potential. As the secondaries will have equal voltages, it follows that the two primaries must divide the line voltage equally between them and that, therefore, the sine waves of secondary voltage will have an amplitude $\frac{\sqrt{3}}{2}$ times as great while carrying current as they would have on open circuit. Each pair of lines supplies current in one direction for 60 degrees, or 30 degrees before and after the maximum voltage between them. During such an interval, the ratio of average to

peak is the same as for six-phase rectifiers, and, if E is the nominal secondary voltage to neutral,

$$G = \frac{\sqrt{3}}{2} \cdot \sqrt{2}E \frac{6}{\pi} \sin \frac{\pi}{6} = \frac{3\sqrt{3}}{\sqrt{2}\pi} E. \quad (13)$$

This results in $E = \frac{\sqrt{2}\pi}{3\sqrt{3}} G$ and the nominal primary and line voltages are $\frac{t_1}{t_2}$ and $\frac{\sqrt{3}t_1}{t_2}$ times as great. The wave shapes are shown diagrammatically in figure 55.

The Y-star connection has as good a utility factor as the double three phase and uses less choke material. It is, however, open to the objection that, if the rectifier proper should stop operation, a Y-connected transformer bank would be left on the line with nothing to prevent the building up of a third-harmonic voltage. The double three-phase circuit is the more popular at present.

Triple-star Circuit.

The triple-star connection has been used a good deal in Germany. Its utility factor is somewhat better than that of the simple six-phase connection, and its regulation is somewhat better. It requires a very complicated transformer, however, and is also subject to the objection of difficulties due to the Y-connected primary with no paths for third-harmonic currents.

Y-star-tertiary Circuit.

The Y-star connection with tertiary winding on the transformer is handicapped by poor utility factors but is free from harmonic troubles, since third harmonics can circulate in the tertiary winding. It also possesses better regulation characteristics than the simple six-phase circuit with delta primary, as will be shown in a later section.

Comparison of Actual and Ideal Rectifiers.

The case of zero resistance and zero inductance in all alternating-current circuits with infinite reactance in the

direct-current circuit is, naturally, never met in practice. It is, however, a fairly close first approximation for use in laying out large polyphase rectifiers, particularly if allowance is made for arc-drop by adding 15 or 20 volts to the desired output voltage and basing calculations on this larger figure.

The most serious failure as an approximation is in connection with the voltage regulation. Both resistance and reactance of the transformer windings cause a drop in the output voltage when the load is applied, and this will be the subject of much discussion in following chapters.

CHAPTER VIII

REGULATION OF RECTIFIERS DUE TO REACTANCE— GENERAL METHODS OF ATTACKING PROBLEM

Resistance in the circuits of a rectifier will, of course, result in a drop in the output voltage when the load is applied. If the wave shapes are not seriously disturbed by the resistance, however, it is usually possible to calculate the regulation due to it by some simple means. With reactance, the problem is more difficult. Regulation in this case is due entirely to the distortion of the wave shapes caused by the inductance of the circuits, and, as most alternating-current systems have more reactance than resistance, the problem is of considerable importance.

Commutation of Anode Currents.

In the preceding chapter, it was assumed that current flows from the anode or anodes at highest potential as determined from light-load conditions when there are no resistance losses or inductive drops. This results in square waves of current as shown in figures 46 or 48. It is obvious, however, that in practice such wave shapes cannot be obtained, for they represent an infinite rate of change of current at the time it is being transferred between anodes, and, with any leakage reactance in the transformer windings and supply network, the resultant induced voltage tending to prevent such a change would be enormous. Transfer of current, then, must occur at a moderate rate and in such a manner that a voltage is available to overcome the inductive drops. Figure 56 illustrates how this occurs. The wave shapes indicated are those for a single-phase circuit as shown in figure 45, but it is now assumed that the transformer windings have leakage reactance. During those portions of the cycle when no current change

is taking place, the anode voltages will have their open-circuit values. Undistorted throughout this period then, the voltage waves will progress as before until the point is reached where they are equal. At this time, the current would transfer immediately if no reactance were present, but this is now a process requiring some time and is not completed until the end of the period u . During this time, the difference in potential between the anodes which would exist under open-circuit conditions is used in over-

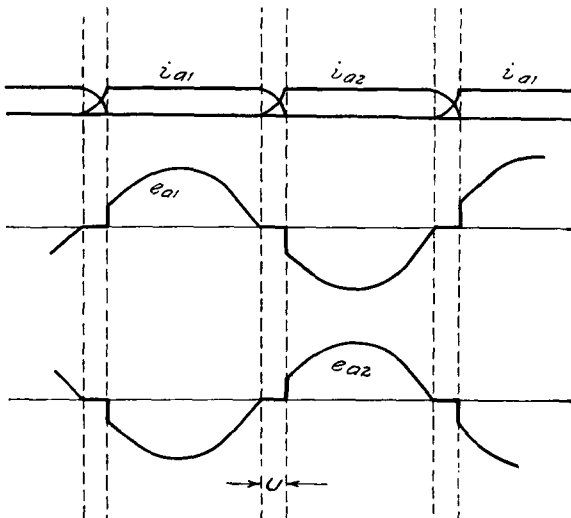

FIGURE 56.—Effect of reactance on wave shapes in a single-phase circuit.

coming the reactive drops inside the transformer windings with the result that neither anode has any voltage on it. In fact, the transformer is temporarily short-circuited, for, since both anodes are carrying current, it is possible for an alternating current to pass between them and thus connect the ends of the secondary windings. This current will, however, be subject to the condition that it cannot acquire a negative value greater than that of the steady current on which it is superimposed, for then the anode current would be of the wrong sign, which is impossible on account of the rectifier action. At the time when the instantaneous value of the short-circuit current is equal

and opposite to the steady current which is carried by an anode, the commutation process stops and leaves zero current flowing to the anode which had been carrying the load and full-load value of current passing to the other anode.

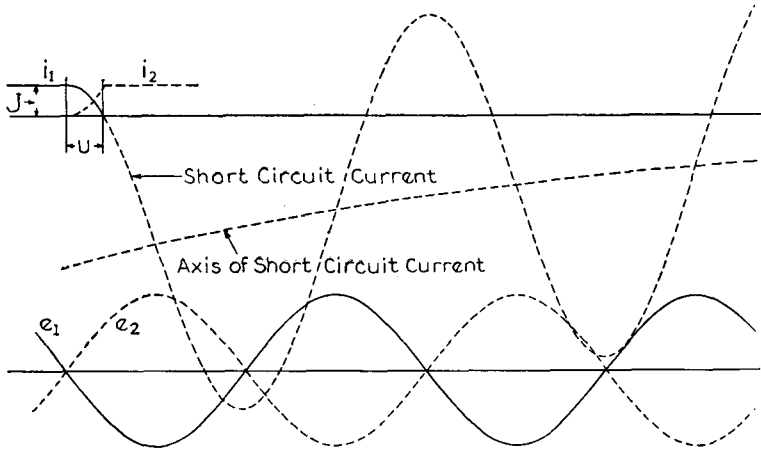

FIGURE 57.—Short-circuit current causing commutation.

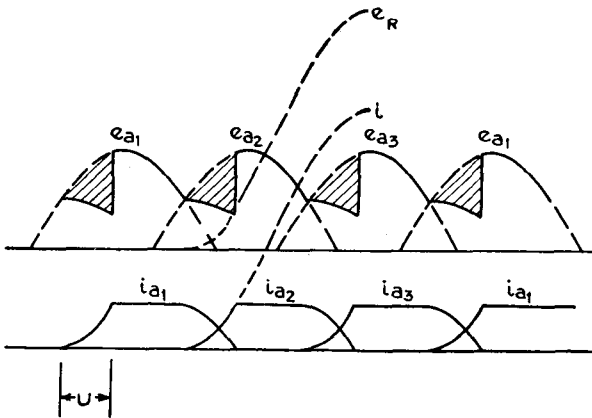

FIGURE 58.—Effect of reactance, three-phase circuit.

The short-circuit current itself is indicated in figure 57. As the voltage causing it is sinusoidal, it will also be sinusoidal, and, if no resistance is present, it will lag behind the voltage by 90 degrees. It will swing about a displaced axis because its amplitude is fixed and, also the point in its

cycle at which it starts, as well as the value which it must have at this time in connection with the steady current represented by its displaced axis. Due to the presence of resistance, the steady component forming the axis will have a decrement, but, for the cases to be considered in this book, it will usually be assumed that there is no resistance and no decrement.

If the rectifier has more than two anodes, commutation occurs in very much the same manner as in the single-phase case, as shown in figure 58. Transfer starts when the voltage of the incoming phase is equal to that of the one carrying current and lasts throughout an angle u , during which both phases involved have a potential midway between their open-circuit values.

Effect of Commutation on Output Voltage.

The output voltage is equal to the average of the instantaneous voltage of the conducting anode from the time when one starts carrying current until the following one begins. It is apparent, therefore, that the changes in wave shape are going to affect the output voltage, and the loss in voltage will be proportional to the shaded areas in figure 58, or the area represented by the missing parts of the sine waves

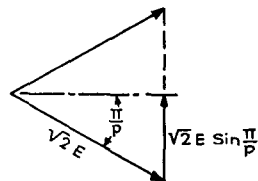

FIGURE 59.—Open-circuit voltage between phases.

in figure 56. This area is equal to the integral of half the open-circuit voltage between phases, starting when it has zero value and continuing through the angle u . As the open-circuit voltage between phases is $2\sqrt{2}E \sin \frac{\pi}{p}$ where E is the open-circuit voltage per phase and p is the number of phases (see figure 59), the loss in output voltage will be given by

$$\begin{aligned}
 e_r &= \frac{p}{2\pi} \int_0^u \sqrt{2}E \sin \frac{\pi}{p} \sin \theta d\theta, \\
 &= \frac{p}{2\pi} \sqrt{2}E \sin \frac{\pi}{p} (1 - \cos u), \qquad (14)
 \end{aligned}$$

which is shown graphically in figure 58. The open-circuit voltage was shown in the last chapter to be equal to

$$G_0 = \sqrt{2}E \frac{p}{\pi} \sin \frac{\pi}{p}, \quad (6a)$$

so that the voltage under load is

$$\begin{aligned} G &= G_0 - e_R, \\ &= G_0 \left(1 - \frac{1 - \cos u}{2} \right). \end{aligned} \quad (15)$$

The angle u can be eliminated from this equation because it is a function of the commutating voltage, leakage react-

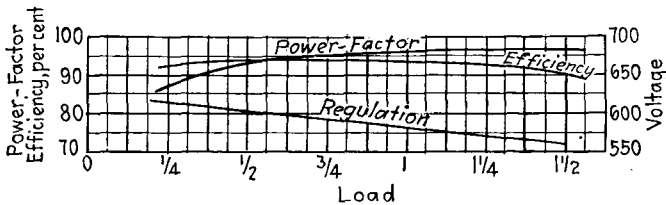

FIGURE 60.—Regulation curve of a large rectifier. The output is expressed in terms of full-load current.

ance, and output current. If the leakage reactance per phase is X , the commutating current will have an amplitude of $\frac{\sqrt{2}E}{X} \sin \frac{\pi}{p}$, and, if the load current is J , commutation will be completed when

$$\frac{\sqrt{2}E}{X} \sin \frac{\pi}{p} (1 - \cos u) = J. \quad (16)$$

By substituting the value of $(1 - \cos u)$ obtained from this in equation (15), there results

$$G = G_0 \left(1 - \frac{JX}{2\sqrt{2}E \sin \pi/p} \right), \quad (17)$$

which indicates a straight-line regulation curve. That such curves are obtained in practice is shown by figure 60, which is the regulation curve for a large iron-tank rectifier up to one and one-half times its normal current rating.

In order to compare the regulation of the various rectifier arrangements covered by Table V, it is convenient to make use of the current value $J_K = \frac{p\sqrt{2}E}{X}$, that is, the peak value of alternating current obtained with a complete alternating-current short-circuit times the number of phases. This will be termed the nominal short-circuit current for reasons which will appear later. Substituting this value in equation (17) gives

$$G = G_0 \left\{ 1 - \frac{p}{2 \sin \pi/p} \left(\frac{J}{J_K} \right) \right\}, \quad (17a)$$

or

$$G = G_0 \left(1 - A \frac{J}{J_K} \right). \quad (17b)$$

Equation (17a) applies for any number of phases where the reactance is in the secondary leads and for such other cases as have an entire phase involved in commutation such as single and three phase. For other cases equation (17a) will not hold true, but equation (17b) may still be used if the proper value of A is known. Table Vc gives the initial slopes of the regulation curves for the various combinations covered by Table V for various locations of the inductance, and gives the range of voltage for which this initial slope is obtained.

The short-circuit currents are also given in Table Vc. Since several different shapes of regulation curves may be obtained the percentage reactance so useful in ordinary alternating-current calculations is no longer sufficient. On the other hand, the load has no variable power factor, so that regulation does not differ for different types of load, except in cases of discontinuous output discussed later.

Reactance of Transformers.

The leakage reactance which a transformer exhibits in polyphase rectifier service usually has a different value from that measured for use of the same transformer with alternating currents. This is not because of any change in

the nature of the phenomenon of leakage reactance, but because of the difference in the paths taken by the short-circuit currents in the two cases. With a polyphase transformer, the ordinary reactance figures are those for a short-circuit involving all the secondary windings. Where the commutating current of a rectifier, however, flows through only two secondaries of different phases, the effect of the coupling between secondaries on the same transformer leg is avoided. The resulting reactance is then the reactance that would be obtained with only these two windings short-circuited. That is, the reactance per phase would be taken as half the open-circuit voltage between phases divided by the short-circuit current obtained by connecting two phases.

In transformers wound for the usual transmission voltages, almost all of the reactance is between primary and secondary so that substantially the same total secondary current will flow with one or two secondary windings short-circuited. That is, where only one-half is short-circuited, the current per winding is double, which is equivalent to saying that the effective impedance to commutation in one coil is substantially half the value obtained with a complete short-circuit.

As the lap angle u increases, the average instantaneous potential for the active anodes falls until a point is reached where a third anode becomes positive enough to tend to take current before the first has dropped to zero. After this point is reached, the hypotheses on which equation (17) is based, no longer apply. Such possibilities are considered in a later chapter.

Effect of Commutation on Transformer Heating.

With the wave shapes obtained in practice, the heating effect of the secondary currents will be less than the value calculated for the square waves, for the overlapping of the waves due to leakage reactance will spread them out over a larger angle and thus reduce their root-mean-square value without affecting their average.

If i is the amplitude of the commutating current and u is the angle of overlap, the loss during the period while the current is building up in a winding will be $\frac{1}{2\pi} \int_0^u i^2 (1 - \cos \theta)^2 d\theta$. If J is the output current, the loss during the decay of current at the end of the conducting period will be $\frac{1}{2\pi} \int_0^u \{J - i(1 - \cos \theta)\}^2 d\theta$. The period during which full-load current is carried is reduced, however, by the angle u , and this means a reduction in the loss equal to $\frac{1}{2\pi} \int_0^u J^2 d\theta$. The net reduction in the loss is, therefore,

$$L_R = \frac{1}{2\pi} \int_0^u J^2 d\theta - \frac{1}{2\pi} \int_0^u i^2 (1 - \cos \theta)^2 d\theta - \frac{1}{2\pi} \int_0^u \{J - i(1 - \cos \theta)\}^2 d\theta,$$

$$= \frac{1}{2\pi} \left[2Ji(u - \sin u) - 2i^2 \left(\frac{3u}{2} - 2 \sin u + \frac{1}{4} \sin 2u \right) \right],$$

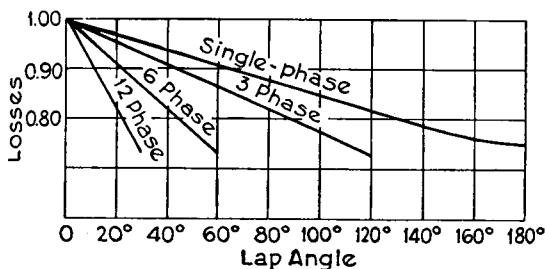

FIGURE 61.—Effect of commutation on heating of transformer secondary windings.

or, as

$$i = \frac{J}{1 - \cos u},$$

$$L_R = \frac{1}{2\pi} \left(\frac{2J^2}{(1 - \cos u)^2} \right) \left(\sin u - \frac{u}{2} - u \cos u + \frac{1}{4} \sin 2u \right).$$

The loss due to square waves is $L_N = \frac{J^2}{p}$ and, hence, the relative reduction in loss is

$$\frac{L_R}{L_N} = \frac{p}{\pi(1 - \cos u)^2} \left(\sin u - \frac{u}{2} - u \cos u + \frac{1}{4} \sin 2u \right). \quad (18)$$

The relative loss may be obtained by deducting this from unity and is shown graphically in figure 61. While the curves apply particularly to the secondary windings, they will also apply to the primary windings in those cases where the primary carries two pulses of current in opposite directions, and each pulse has the same form as the secondary-current wave.

General Methods Used in Attacking Regulation Problems.

The simple regulation problem solved in the beginning of this chapter indicates the complexity which may be expected in cases where several anodes carry current simultaneously. Ready solution of these problems demands a set of viewpoints differing from those in general use which soon submerge any calculations under a large mass of figures from which it is difficult to extract any useful results. Physical conceptions must be reduced to the simplest and clearest forms and full advantage taken of any mathematical short cuts which may be found.

The advantage to be gained by reduction of the circuit into an equivalent circuit of fewer parts has already been demonstrated by several examples. Another powerful aid in making calculations is to divide the voltage into simple parts and work out the current for each part separately and then add these components to get the total current. Each component of the voltage will cause a corresponding component of the current to flow as though there were no other voltages or currents in the system, and it will be seen that no new mathematics is involved in doing this. The whole scheme might be compared to writing out the usual equations using inks of different colors so that terms which are closely related would have their connection indicated at once. Considerable simplification of the problem is often obtained by thus dividing it into parts, and its physical side stands forth with greater clearness, which means that the chances for error are diminished.

An application of this method is demonstrated by the solution of the battery-charging rectifier problem.

Battery-charging Rectifiers.

These rectifiers are of a special and very simple type. They can be used only for certain kinds of service, but in their field they are both highly satisfactory and quite inexpensive. Their distinguishing features are the absence

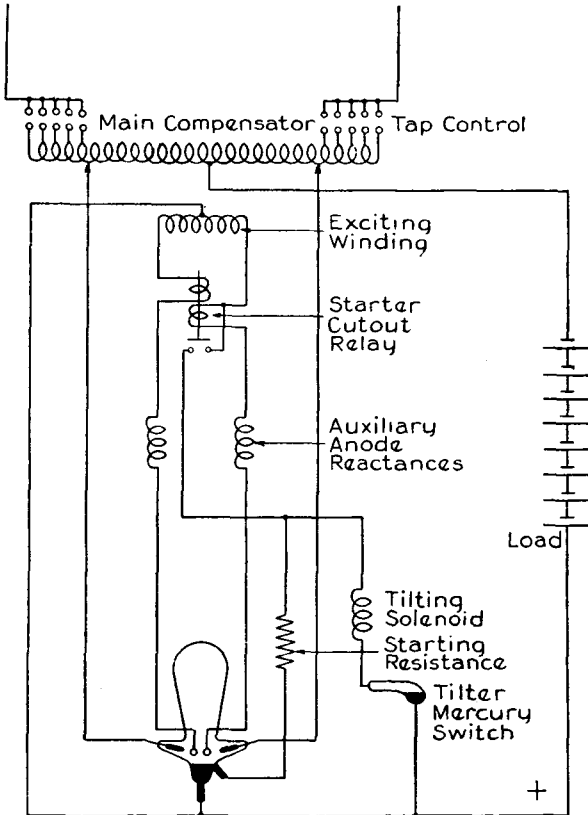

FIGURE 62.—Wiring diagram of a battery-charging rectifier.

of a choke in the output circuit and the control of current by reactance in the transformer or anode leads. The absence of a choke means that they will not deliver a continuous output current, but for charging batteries this is immaterial. The circuit for such a rectifier including excitation of the holding arcs and an automatic starter is

shown in figure 62. Figure 63 shows a commercial rectifier of this type. Alternating power may be derived from a compensator, as shown in figure 62, or from a transformer with separate primary and secondary windings.

Operation of Battery Chargers with Reactance in the Anode Leads.

In discussing the operation of battery-charging rectifiers it will be found convenient to consider first one in which

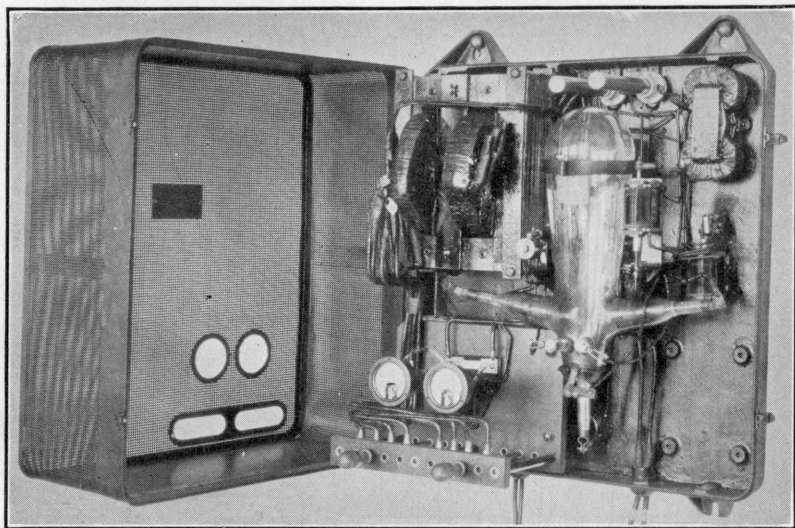

FIGURE 63.—Battery-charging rectifier.

all the reactance may be treated as though lumped in the anode leads. If the load is thrown on the rectifier at a point in the cycle when neither half of the transformer secondary has a voltage as large as that of the battery, the current will not start until the instantaneous value of the alternating voltage becomes equal to the counter electromotive force presented by the battery. The current which then commences to flow through the battery, transformer winding, and the reactance in the circuit will be due to the difference in the alternating and direct voltages acting on the reactance. These voltages are shown in figure 64,

and, if current flows from either anode through an angle 2θ , the average value of the alternating voltage during this period must be equal to the output voltage G , for the current

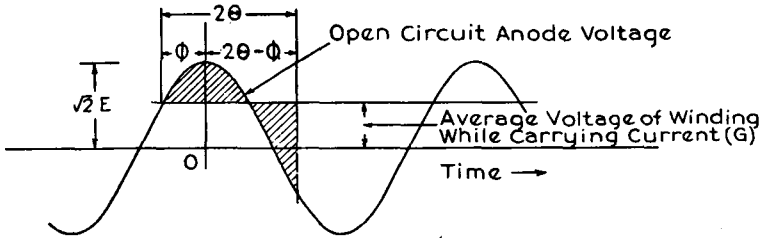

FIGURE 64.—Relation of direct and alternating voltages in a battery charger.

starts at zero and has the same value at the end of the conducting period, which means that the average voltage applied to the reactance must be zero.

Since the average voltage during the conducting period must be equal to the output voltage, and since conduction begins at the instant when the alternating and output voltages are equal, it appears that there must be a connection between the phase angle at the time current starts to flow and the angle during which conduction takes place. If conduction begins at a time before the maximum voltage is reached represented by the angle ϕ , the average voltage as obtained by integration over the conducting period will be

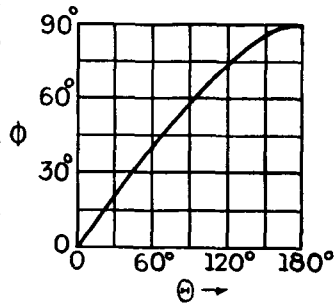

FIGURE 65.

$$G = \frac{1}{2\theta} \int_{-\phi}^{2\theta-\phi} \sqrt{2}E \cos \theta d\theta = \frac{E}{\sqrt{2\theta}} [\sin (2\theta - \phi) + \sin \phi],$$

$$= \frac{\sqrt{2}E}{\theta} \sin \theta \cos (\theta - \phi). \tag{19}$$

But the average voltage as given by starting conditions is

$$G = \sqrt{2}E \cos \phi; \tag{20}$$

hence, $\sqrt{2}E \cos \phi = \frac{\sqrt{2}E}{\theta} \sin \theta \cos (\theta - \phi)$

from which

$$\tan \phi = \frac{\frac{\theta}{\sin \theta} - \cos \theta}{\sin \theta} \tag{21}$$

The relation between ϕ and θ is shown graphically in figure 65.

Knowing the relations between the voltages and the angles θ and ϕ , it is now possible to calculate the current.

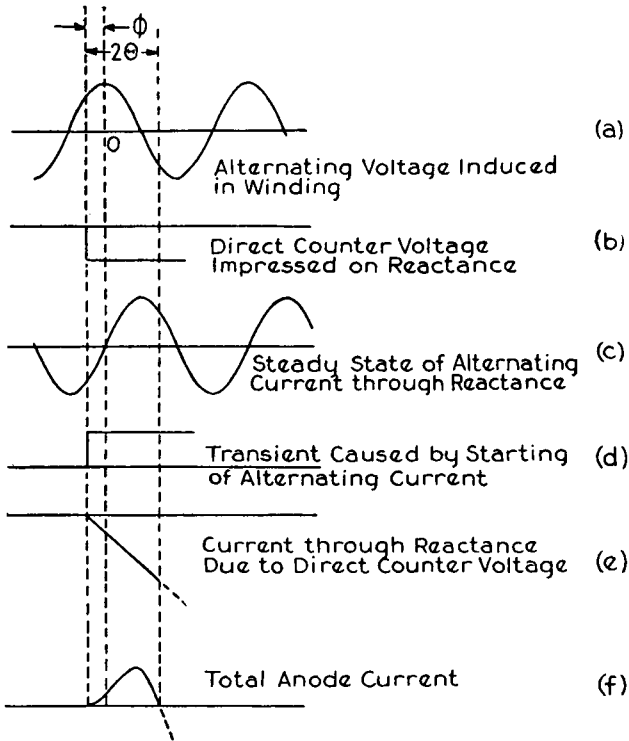

FIGURE 66.—Components of current wave of a battery charger.

The manner in which this is accomplished is shown in figure 66. The transformer winding has induced in it a sine wave of voltage, as shown by *a*. As soon as conduction of current commences, this voltage is impressed on the reactance of the circuit together with the direct counter voltage of the battery being charged, which is shown by *b*. These two

voltages may be assumed to cause two separate currents to flow through the reactance of the circuit which, for the present, is considered as though lumped in the anode leads. Neglecting the starting value, the alternating voltage will result in a simple sine wave of current, as shown at *c*. The value of this wave at the time of starting of the current is not zero, however, but this is easily remedied by assuming a steady current of opposite sign to start at the same instant, as shown by *d*. Such a current of the proper magnitude will compensate for the starting value of the sine wave and yet requires no voltage for its maintenance. The direct voltage of the battery will, of course, produce a current increasing uniformly with time and of negative sign, as shown at *e*, and, by adding all the components of the current together, the total current is obtained, as given by *f*.

Value of the Output Current.

The instantaneous value of the anode current can now be written very easily. Denoting $2\pi f$ by ω , the component of current due to the alternating voltage will be $\frac{\sqrt{2}E}{\omega L} \sin \omega t$, and the transient caused by starting it will be $\frac{-\sqrt{2}E}{\omega L} \sin(-\phi)$. The direct voltage is $\sqrt{2}E \cos \phi$, and the current component due to it will be

$$-(\sqrt{2}E \cos \phi) \left(\frac{t + \phi/\omega}{L} \right).$$

The addition of these results in

$$i = \frac{\sqrt{2}E}{\omega L} \sin \omega t + \frac{\sqrt{2}E}{\omega L} \sin \phi - \sqrt{2}E \cos \phi \left(\frac{t + \phi/\omega}{L} \right). \quad (22)$$

The output current per anode will then be given by

$$\frac{J}{p} = \frac{\omega}{2\pi} \int_{\omega t = -\phi}^{\omega t = (2\theta - \phi)} i dt,$$

where J is the output current and p is the number of anodes.

Hence,

$$\begin{aligned} \frac{J}{p} &= \frac{1}{2\pi} \int_{-\phi}^{2\theta-\phi} \left[\frac{\sqrt{2}E \sin(\omega t)}{\omega L} + \frac{\sqrt{2}E \sin \phi}{\omega L} - (\sqrt{2}E \cos \phi) \left(\frac{\omega t + \phi}{\omega L} \right) \right] d(\omega t), \\ &= \frac{\sqrt{2}E}{2\pi\omega L} \left[-\cos(\omega t) + (\omega t) \sin \phi - \frac{1}{2}(\omega t + \phi)^2 \cos \phi \right]_{-\phi}^{2\theta-\phi}, \\ &= \frac{\sqrt{2}E}{2\pi\omega L} [-\cos(2\theta - \phi) + \cos(-\phi) + 2\theta \sin \phi - 2\theta^2 \cos \phi], \\ &= \frac{\sqrt{2}E}{\pi\omega L} [\sin(\theta - \phi) \sin \theta + \theta \sin \phi - \theta^2 \cos \phi]. \quad (23) \end{aligned}$$

Output Current and Voltage as Functions of θ .

Equations (20), (21), and (23) contain all that is necessary in order to express the relation between the output voltage and current. That

is, ϕ is a function of θ , and G and J are functions of ϕ and θ and can be expressed in terms of θ as a parameter. If desired, the relation between G and J could be expressed without using θ , but there is no real reason for desiring its elimination. Figure 67 indicates how G and J vary with θ .

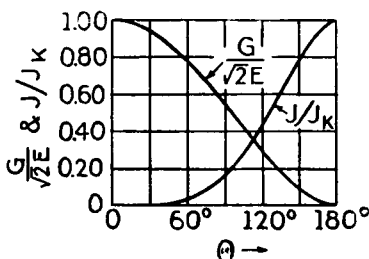

FIGURE 67.

The voltage is expressed in terms of the no-load alternating peak value which is $\sqrt{2}E$ and the current is expressed in terms of the nominal short-circuit J_k which, however, would not be attained in practice except in this case where all the reactance is in the secondary leads. The value of J_k will be defined as $\frac{\sqrt{2}E p}{X}$, where X is the apparent reactance of each secondary lead on a polyphase alternating-current short-circuit. Figure

68 shows $\frac{G}{\sqrt{2}E}$ as a function of $\frac{J}{J_K}$. The points on the curve represent values of θ taken at 15-degree intervals.

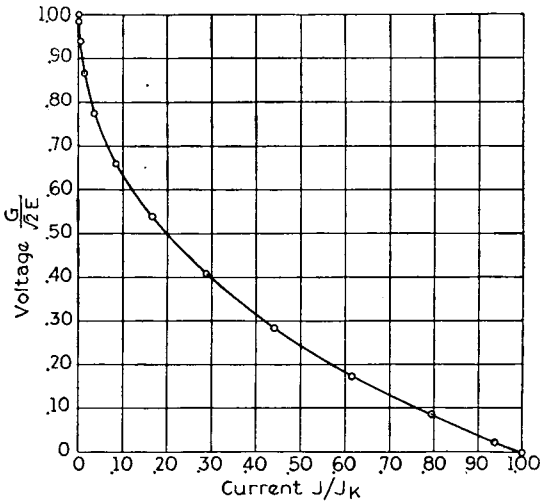

FIGURE 68.—Regulation curve of a battery charger in which the reactance may be considered as though lumped in the anode leads.

Short-circuit Output Current.

The actual short-circuit output current can be obtained by substituting in equation (23) the corresponding values of θ and ϕ which are 180 and 90 degrees and this results in

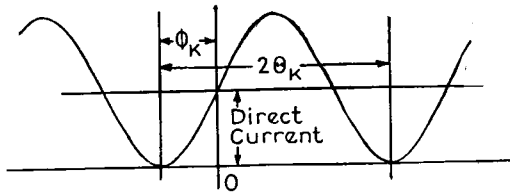

FIGURE 69.—Short-circuit anode-current wave when all the reactance is in the anode leads.

a value equal to the nominal short-circuit current. Figure 69 indicates the shape of the anode-current wave. Each anode carries an alternating current and a superposed direct current equal in magnitude to the peak of the alternating-current wave. There is now no current com-

ponent increasing with time, for there is no direct counter voltage to cause it. Current flows from each anode throughout the entire cycle, and it is obvious that this must be so if the average value of the induced voltage, while current is flowing, is to be zero. The peak value of the alternating component of current is $\frac{\sqrt{2}E}{\omega L}$, and this will also be the value of the direct current contributed to the output by each phase. For convenience, this short-circuit wave form of anode current will be assumed as the basis of reference throughout this book and the output current which it represents will be designated the nominal short-circuit output current. For p phases, the nominal short-circuit current J_K will be

$$J_K = \frac{\sqrt{2}Ep}{\omega L}. \quad (24)$$

Actual and nominal short-circuit current are equal only in the case where all the reactance is in the secondary leads and in a few other cases where there is no coupling between anodes.

The use of equation (24) to eliminate E , p , and ωL from equation (23) results in

$$\frac{J}{J_K} = \frac{1}{\pi}[\sin(\theta - \phi) \sin \theta + \theta \sin \phi - \theta^2 \cos \phi], \quad (25)$$

which is the function plotted in figure 67.

Effect of Primary Reactance.

So far, it has been assumed that the reactance of the rectifier circuit is of such a nature that it can be considered as though lumped in the anode leads. In practice, however, this will be only a special case. It is thus necessary to see what the effect of other distributions of reactance may be. Considering light loads where each anode carries current for less than 180 degrees, it is apparent that the location of the reactance whether in the primary or secondary will not affect either the output voltage or the current

wave shape except that with primary reactance the reactance presented to the commutating current will be half that determining J_K .

When current tends to be carried by an anode for 180 degrees or more, it is necessary to reexamine the conditions of operation. Consider the case where all the reactance is in the primary winding if a transformer is used or in the supply lines if a compensator is employed. Then an anode cannot carry current for more than 180 degrees because, while either anode is carrying current, it will be at battery

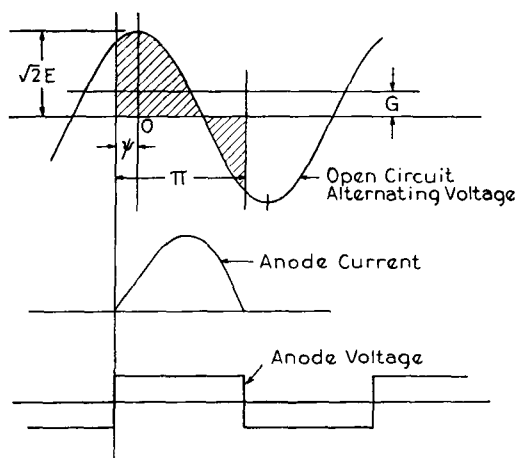

FIGURE 70.—Wave shapes of a battery charger in which the reactance may be considered as though in the transformer primary.

potential and the other anode must be at an equal and opposite potential. Hence, only one anode can carry current at a time, and each will carry current for 180 degrees or less.

The wave shapes obtained under these circumstances are shown in figure 70. They differ markedly in two points from those obtained with secondary reactance. First, the output voltage and open-circuit transformer voltage are not equal at the time an anode starts to carry current. One anode starts to carry current because the other has ceased and thus has left the first anode with a voltage which

would be above that of the output except for the reactive drop in the primary inductance due to the current rise. This quick starting of the current is different from that previously obtained where the rate of increase of current was zero at the time it started to flow. When this difference is traced further, it is found that the short-circuit

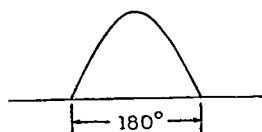

FIGURE 71.—Short-circuit anode-current wave when all the reactance is in the transformer primary.

current wave is one-half of a sine wave, as shown in figure 71, and flows for only 180 degrees instead of 360 degrees as before.

Regulation Curve of Battery Charger with Reactance in Primary.

The regulation curve of a rectifier with all the reactance in the primary will follow the same form as that corresponding to secondary reactance until the anode current waves become 180 degrees in length, with one important difference. Due to the fact that the secondaries can now affect the voltage of each other, it will be found that the equivalent secondary reactance per winding on an alternating-current short-circuit involving both secondaries will be twice as great as the equivalent reactance per winding if only one secondary is involved. If one value of reactance is used in calculating the regulation, the value of reactance used in calculating the nominal short-circuit current must be double this and the ratio of J to J_K for the same voltage drop will be twice that obtained with reactance in the anode leads.

The regulation curve from the point where current is first carried for 180 degrees until short-circuit is reached may be calculated in a manner similar to that used in obtaining the first curve. If conduction begins at an

angle ψ before the maximum of the open-circuit alternating-current voltage wave is reached, then

$$\begin{aligned} G &= \frac{\sqrt{2}E}{\pi} \int_{-\psi}^{\pi-\psi} \cos \theta d\theta, \\ &= \frac{\sqrt{2}E}{\pi} [\sin \theta]_{-\psi}^{\pi-\psi} = \frac{2\sqrt{2}}{\pi} \sin \psi. \end{aligned} \quad (26)$$

The alternating component of current due to the alternating voltage will be $\frac{\sqrt{2}E}{\omega L} \sin \omega t$, and the corresponding transient $\frac{\sqrt{2}E \sin \psi}{\omega L}$. The current due to the counter voltage will be $-\frac{2\sqrt{2}E \sin \psi}{\pi} \left(\frac{t + \psi/\omega}{L}\right)$. Hence,

$$i = \frac{\sqrt{2}E}{\omega L} \left[\sin \omega t + \sin \psi - \frac{2 \sin \psi}{\pi} (\omega t + \psi) \right], \quad (27)$$

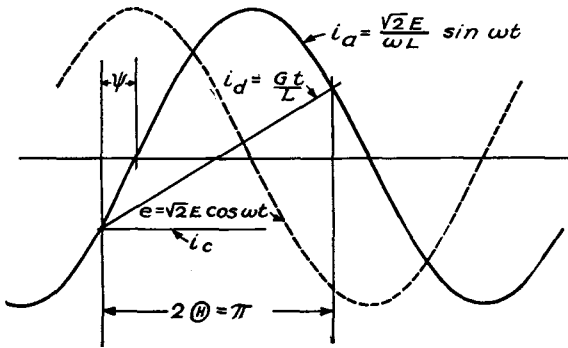

FIGURE 72.

and the output current per phase will be

$$\begin{aligned} \frac{J}{p} &= \frac{\sqrt{2}E}{2\pi\omega L} \int_{-\psi}^{\pi-\psi} \left[\sin \omega t + \sin \psi - \frac{2 \sin \psi}{\pi} (\omega t + \psi) \right] d(\omega t), \\ &= \frac{\sqrt{2}E}{2\pi\omega L} \left[-\cos(\omega t) + \omega t \sin \psi - \frac{2 \sin \psi}{\pi} \frac{(\omega t + \psi)^2}{2} \right]_{-\psi}^{\pi-\psi}, \\ &= \frac{\sqrt{2}E}{2\pi\omega L} [2 \cos \psi + \pi \sin \psi - \pi \sin \psi] = \frac{\sqrt{2}E \cos \psi}{\pi\omega L}. \end{aligned} \quad (28)$$

This section of the regulation curve can also be determined by inspection of figure 72 which is a modification of figure 66 for $2\theta = \pi$. The alternating voltage is $e = \sqrt{2}E \cos \omega t$ as before. The alternating-current component is

$$i_a = \frac{\sqrt{2}E}{\omega L} \sin \omega t. \quad \text{The transient current and the current}$$

i_d due to the counter electromotive force are reversed and added so that the crossing points of i_a and i_d are the points of zero current. The line i_d is equally above and below the axis so that the average current is not affected by it but is fully determined by the average of the sine component, that is, the average of a sine wave for 180 degrees,

$$\frac{J}{p} = \frac{\sqrt{2}E}{X} \cdot \frac{1}{2\pi} \int_{-\psi}^{-\psi+\pi} \sin \omega t \, d(\omega t) = \frac{\sqrt{2}E}{X} \cdot \frac{1}{\pi} \cos \psi.$$

The change in i_d for a duration of π is

$$\frac{2\sqrt{2}E}{X} \sin \psi = \frac{G(\pi/\omega)}{L} = \frac{\pi G}{X},$$

or
$$G = \frac{2\sqrt{2}E}{\pi} \sin \psi.$$

These values, therefore, check those obtained by algebra.

Output current and voltage are thus found to be, respectively, sine and cosine terms of the same variable, which means that the resultant curve is part of an ellipse. The nominal short-circuit current per phase will be given by

$$\frac{J_K}{p} = \frac{\sqrt{2}E}{\omega L'}, \quad (29)$$

where $\omega L'$ is the reactance on complete short-circuit and L' has been found to be twice L . Hence,

$$\frac{J}{J_K} = \frac{2 \cos \psi}{\pi}, \quad (30)$$

which has a maximum value on a short-circuit of $\frac{2}{\pi}$ corresponding to a value of zero for ψ .

The complete regulation curve for a battery charger with all the reactance in the primary is shown in figure 73 and is more desirable than the curve obtained with secondary reactance for applications where a lower ratio of short-circuit current to current obtained at normal working voltages is required.

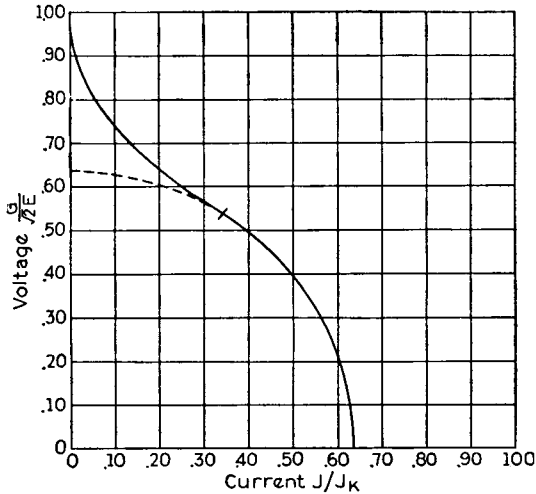

FIGURE 73.—Regulation curve of a battery charger in which the reactance may be considered as though in the transformer primary.

Regulation of Battery Chargers with Distributed Reactance.

The regulation of a battery charger having its reactance distributed between the primary and the secondary can be readily calculated in the case where an anode carries current for less than 180 degrees. By measuring the apparent reactance of the secondary windings with only one winding short-circuited at a time a value of reactance is obtained which may be used in the calculations as though lumped in the anode leads. Substitution of this figure in the equation for the nominal short-circuit current instead of that obtained with complete short-circuit results in a special quantity in terms of which the output current can be expressed as it was expressed in terms of J_k in the case

with secondary reactance. The regulation curve will, therefore, be given by figure 68, as in the previous case, except that J will be measured in terms of the special quantity just defined instead of J_K .

After the period of conduction reaches 180 degrees, this method can no longer be applied. This case is of such limited interest that it will not be discussed in this book.

Construction of Transformers for Battery-charging Rectifiers.

Reactances in the anode leads are expensive because they are subject to saturation by the direct current, and this is another reason for using primary reactance except in the auxiliary holding-arc circuits where a large current overlap is of primary importance. The primary reactance, however, need not be a separate piece of apparatus; all that is required is to separate the secondary windings from the primary in such a way that there will be considerable leakage between the windings. This will result in a high leakage reactance which may be considered as though in the primary. The two secondary windings must be arranged, however, so that there is no appreciable leakage between them.

Voltage of Battery Chargers Is Dependent on Type of Load.

It is interesting to notice that the output voltage of battery chargers of the type discussed here is dependent upon the counter electromotive force of the battery being charged. If a battery is replaced by a resistance capable of absorbing the same power at the battery voltage, the voltage of the rectifier will drop. The rectifier normally operates for only part of the cycle, during which its output voltage is equal to that required to overcome the counter voltage of the battery, and during the idle portions of the cycle its terminal voltage is maintained by the battery. When the battery is replaced by the resistance, the latter is not only incapable of maintaining a steady voltage but will also draw current all the time from whichever anode is most positive

and thus reduce the average voltage by lengthening the period over which the average is taken.

Conditions of Service of Battery Chargers for Lead Storage Batteries.

In charging lead storage batteries, the first requirement is to put in a certain number of ampere-hours charge in the available time. In doing this, however, there is a limiting rate at which the battery can be charged. When the battery is nearly discharged, it can be fed a fairly high current without danger, but, as it charges up, the rate must be decreased because more energy is then used in heating the parts instead of producing the desired chemical changes. Furthermore, as the battery charges up, its electromotive force increases and a higher voltage is necessary to charge it even though the current drawn may be less. The volts and amperes of a battery being charged under the usual conditions will, therefore, be of the nature indicated by figure 74.

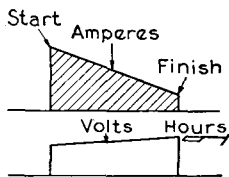

FIGURE 74.—Volt-ampere characteristic of a battery being charged.

It would add to its usefulness if the regulation of the rectifier could be made of such a value that it would give automatic adjustment of the current as the charge progresses. This can be accomplished by operating in the proper section of the regulation curve as given by figures 68 and 73. To determine conveniently the correct operating range, the curves of figures 68 and 73 are first replotted with the currents and voltages to logarithmic scales, as in figure 75. When the ratio of starting to finishing current is given, this will then be represented by a fixed horizontal distance regardless of the actual values. The voltages at start and finish will also be known, and their ratio will be shown by a corresponding vertical distance. These two increments together will then represent the slope which the regulation curve must have when plotted, as in figure 75, and, by picking out the portion of the characteristic having

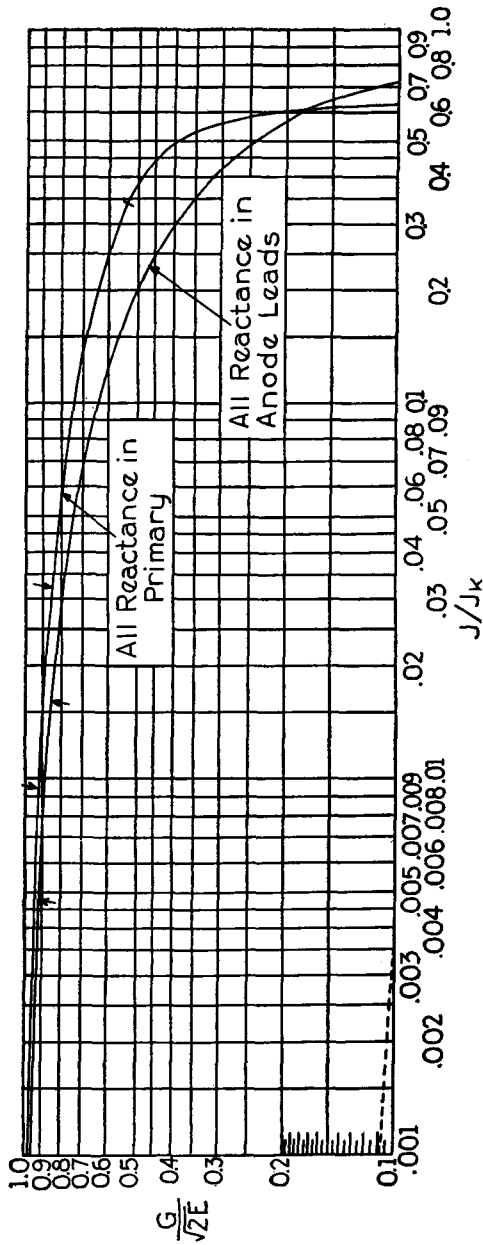

FIGURE 75.—Regulation curves of battery chargers to logarithmic scales.

this slope, the values of $\frac{G}{\sqrt{2E}}$ at start and finish of the charge are readily determined.

Effect of Arc-drop.

The arc-drop has been neglected up to this point, but it must be considered in an actual application. Since it is substantially constant and because of its location in the circuit, it may be treated as part of the battery voltage. The potential G then consists of the battery voltage plus the arc-drop.

Example of Voltage Calculations for Battery Charger.

Let it be supposed that full charge for a certain lead battery can be obtained in 8 hours with a starting current three and one-half times that at the finish and that during charge the cell voltage rises from 2.21 to 2.48. If there are sixteen cells in the battery and a 15-volt arc-drop in the rectifier, the value of G will be $(16 \times 2.21) + 15 = 50.36$ volts at the start of the charge and $(16 \times 2.48) + 15 = 54.68$ volts at the finish. The ratio of these voltages is 1.085, and, in connection with the current ratio, this gives a slope as shown in the lower left corner of figure 75. The arrows indicate the points on the two regulation curves between which this average slope is obtained. It appears that the value of $\frac{G}{\sqrt{2E}}$ is 0.848 at the start of the charge and 0.92 at the finish.

When the currents to be delivered by the rectifier are known, the reactance of the transformer can be readily determined. Figure 75 gives the actual currents in terms of the nominal short-circuit output currents, and, when the latter are known, the reactance of the transformer is given by equation (24) or (29).

Heating Value of Current.

The root-mean-square value of the anode current can be obtained by squaring the instantaneous value given

by equation (22), integrating, averaging, and then extracting the square root. This is a rather lengthy and tedious process and is not altogether satisfactory because the answer depends on the difference of relatively large quantities. The results obtained are shown in figure 76, and it appears that the ratio of root-mean-square to average current is approximately one and one-fourth times the square root of the reciprocal of the fraction of a cycle during which an anode is conducting.¹ This might be expected

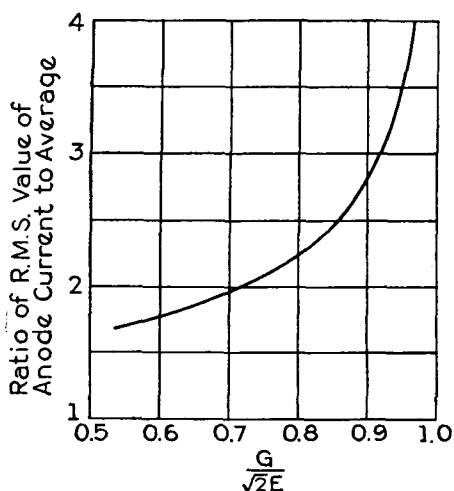

FIGURE 76.—Heating value of battery-charger anode currents.

because the ratio of root-mean-square to average for square waves is exactly equal to the square root of the reciprocal of the conducting period. Figure 76 covers only the range where conduction is for less than 180 degrees. This type of rectifier meets the conditions discussed in the preceding chapter for which the nominal primary volt-amperes are $\frac{1}{\sqrt{2}}$ times the sum of those in the secondaries.

¹ The connection between the period of conductivity and voltage ratio is indicated in figure 67.

Charging of Edison Batteries.

Although the examples given apply to lead batteries, the curves and equations may be used equally well for Edison cells. For lead cells the most favorable characteristic is the one employing the greatest ratio of initial to final charging rate, whereas the Edison cell is best charged at a substantially constant current. The actual designs for chargers for the two purposes are quite different although the principles are the same.

CHAPTER IX

REGULATION OF RECTIFIERS HAVING ALL THEIR REACTANCE IN SECONDARY WINDINGS¹

It was seen in the preceding chapter that, by first calculating the performance of battery-charging rectifiers as though all the reactance was in the anode leads, a solution was obtained which was later found to be applicable with slight variations to other conditions. In discussing rectifiers having chokes in the output circuit, it will be convenient to start with the same assumption, for, although the condition is not met in practice, the results of the calculations will be found to be of considerable value. The arc-drop and resistance losses will be assumed to be so small that their effect on the wave shapes may be neglected. They can then be disregarded until the end of the calculations is reached, at which point a simple correction will make allowance for them. This means that the regulation will be considered as though due in large part to the effect of the reactance of the transformer windings—an assumption well justified by the facts, except in the case of certain small transformers which have a resistance of unusual magnitude as compared with their leakage reactance.

Rectifier with an Infinite Number of Phases.

If a hypothetical rectifier having an infinite number of phases is chosen for purposes of discussion, it will be found to be a useful starting point. Except at no load the output current will always be supplied by a group of phases operating in parallel. Phases entering the portion of the cycle in which they carry current acquire their share of the current slowly and do not cease to carry it until other phases having a higher induced potential take it from them.

¹ This chapter follows work of DÄLLENBACH and GERECKE, as explained in the preface.

This means that, instead of a phase carrying current for only that portion of the cycle where it has a higher induced potential than the other phases, it will continue to carry current after its induced voltage has passed below those of some of the phases which follow it.

In figure 77, the secondaries are shown connected in a star with the free end of each winding connected to an anode. The currents from these anodes will pass to a common cathode, through the load, and back to the midpoint of the star. Each secondary winding will be supposed to have a leakage inductance L and this will be considered to represent all the reactance which need be taken into account, except for the choke in the output circuit which will be assumed to be of sufficient size to prevent any ripple current from flowing. The group of phases carrying current at any time is indicated as comprising an angle 2θ and this means that the induced voltages of the windings carrying current at any time vary in phase throughout a corresponding angle or that any particular anode will carry current during a portion of the cycle equal to 2θ .

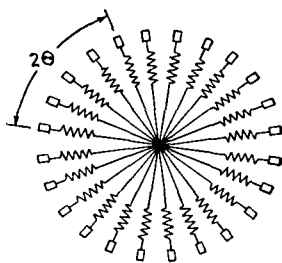

FIGURE 77.—Rectifier with infinite phases.

Potential of a Group of Phases Carrying Current.

While the induced voltages of the windings which carry current at any instant are not equal, it is impossible for this difference to show itself at the anodes. Those which carry current are all at substantially the same potential with respect to the cathode, for the arc-drop is not only small but also practically constant. The difference in any winding between the terminal voltage and the induced voltage is used in producing a change in the current in that winding. Thus, if the potential of the group is g and the induced voltage of the phase is $\sqrt{2}E \sin(\omega t + \psi_a)$, the difference will be equal to $L \frac{di_a}{dt}$ for anode a .

As the sum of the anode currents is held constant by the direct-current choke, the sum of the rates at which they are changing must be zero. Hence, if the voltages of the different anodes are written down and added, it is found that the voltage of the group is equal to the average induced voltage of the windings carrying current.

Thus,

$$\begin{aligned}\sqrt{2}E \sin (\omega t + \psi_1) - L \frac{di_1}{dt} &= g, \\ \sqrt{2}E \sin (\omega t + \psi_2) - L \frac{di_2}{dt} &= g, \\ \sqrt{2}E \sin (\omega t + \psi_3) - L \frac{di_3}{dt} &= g, \\ \Sigma \sqrt{2}E \sin (\omega t + \psi_a) - \Sigma L \frac{di_a}{dt} &= ng,\end{aligned}$$

where n is the number of anodes carrying current at the same time. And, as

$$\begin{aligned}\Sigma L \frac{di_a}{dt} &= 0, \\ g &= \frac{1}{n} \Sigma \sqrt{2}E \sin (\omega t + \psi_a).\end{aligned}\tag{31}$$

In the case of infinite phases, there will always be so many phases contributing to g that it will contain no ripple and will therefore be equal to the steady output voltage G . The choke in the output circuit is therefore superfluous in this particular case. Furthermore, equation (31) may be expressed as an integral instead of a summation. The maximum value of this integral would result if the winding in the center of the conducting belt were at its maximum induced potential and would be given by

$$V = \frac{1}{2\theta} \int_{-\theta}^{+\theta} \sqrt{2}E \cos \omega t d(\omega t) = \frac{\sqrt{2}E \sin \theta}{\theta}.\tag{32}$$

As the average induced voltage of a fixed group of windings represents a summation of sinusoidal voltages of a single frequency, it follows that it will also vary sinusoidally and at the same frequency. Its maximum value will be

given by V and it will be in phase with the induced voltage of the winding in the center of the group. By this means it is possible to calculate the voltage of the group of conducting phases when the width of the group 2θ and the time phase of the voltage induced in the central winding are known.

Conditions under Which a Phase Enters the Conducting Group.

A phase becomes part of the conducting group when its induced voltage becomes equal to the average induced voltage of the group as shown in figure 78, and, as long as its

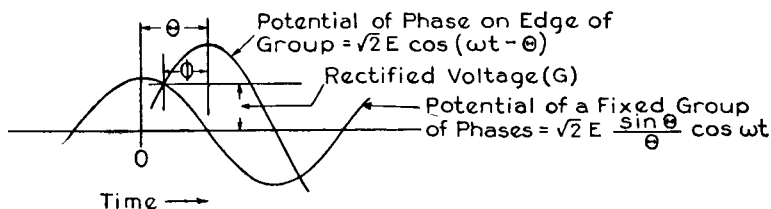

FIGURE 78.—Conditions under which the incoming phase enters the conducting group (infinite-phase case).

induced voltage is greater than that of the group, it gains current continuously. After it has been in the group a while, its induced voltage falls below that of the group and then it loses current steadily until zero value is reached, at which point it leaves the group.

Characteristics of Rectifier with Infinite Phases.

During the time a phase is in the conducting group its average induced voltage must be equal to the average induced voltages of all the phases in the group at any instant, which has been shown to be G , the output voltage. Hence, the output voltage of a rectifier of infinite phases must be the same as that of the battery charger when the anodes in both are carrying current throughout the same angle, for in both cases conduction commences when the induced voltage is equal to the average during the conducting period and this average voltage is the output potential.

Furthermore, the secondary windings will have the same voltages impressed on them in both cases and similar current waves must result. For these reasons then, the regulation curve of a rectifier of infinite phases will be the same as that of the battery charger with secondary reactance, as shown in figure 68.

Conditions Prevailing When Several Anodes Carry Current Simultaneously.

The special cases of regulation characteristics which have been discussed illustrate the means to be used in attacking the more general problem where several phases carry current simultaneously, and the total number of phases cannot be considered as infinite. From the battery charger and the case with an infinite number of phases, it is seen how the current in any phase may be determined by separating all the voltages which act upon it and calculating the effect of each separately. There will now be an additional voltage, however, representing the irregularities in the rectified wave due to the smaller number of phases being used. As before, an anode will start to conduct current at the time the induced voltage of the corresponding winding is equal to the average value of the induced voltages in all the windings carrying current. This average voltage can, however, no longer be considered as continuously equal to the direct output potential, because of the ripple produced in it by the use of a limited number of phases. Instead, its value must be calculated with the aid of diagrams similar to those used in discussing the limited case involving conduction by only one or two anodes.

Conditions under Which a Phase Enters the Conducting Group are Dependent Only on the Number of Phases in the Group.

An anode becomes active when its induced potential becomes more positive than the potential of the active anodes. For instance, referring to figure 79, if anode t

only is carrying current, transfer will begin at α_1 where e_u becomes greater than e_t . If anodes s and t are carrying current, e_u need only exceed their average e_{st} which it does at α_2 , and so on. These values of α can be severally determined by solving for the points of intersection. A better method, however, is obtained by vector representation of the voltages, as shown in figure 80. The induced voltages of $n - 1$ phases $q, r, s,$ and t which are already carrying current are shown by the vectors $OQ, OR, OS,$ and OT . Their average value is represented by OY . The voltage of the incoming phase u is shown by OU .

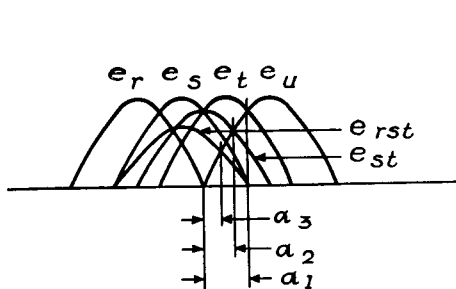

FIGURE 79.—Conditions under which the incoming phase enters the conducting group (case with a finite number of phases).

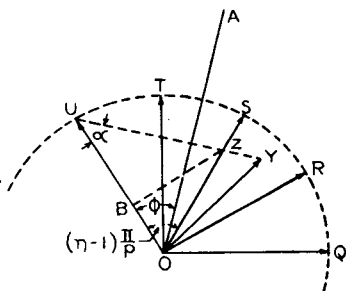

FIGURE 80.—Vector relations at time phase enters conducting group.

The actual value of the voltages at any instant is shown by their projection upon a line with respect to which they have a relative angular velocity of $2\pi f$. The incoming phase becomes part of the group at the instant when the vector representing the group voltage and that representing the potential of the incoming phase have equal projections upon the reference line. OA represents the relative position of the reference line when this occurs. It is drawn perpendicular to OY . The angle ϕ between OU and OA is then the angle by which the voltage of phase u is displaced from its maximum value at the time it becomes conducting, while α represents the angle by which it is displaced from zero value. Both these angles are clearly independent of load except as the load influences the

number of active anodes. After phase *u* has become part of the conducting group, it contains *n* phases. The average voltage of the group is now represented by the vector *OZ* which must of necessity have the same projection on *OA* as *OU* and *OY*.

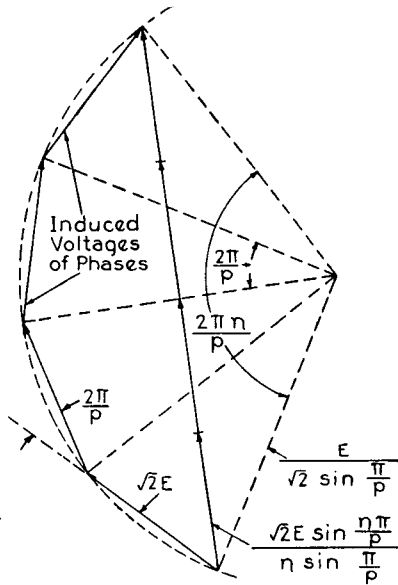

FIGURE 81.—Average voltage of phases operating in parallel.

A convenient function of α to evaluate is its tangent

$$\tan \alpha = \frac{BZ}{UB} = \frac{OZ \sin (n-1) \frac{\pi}{p}}{OU - OZ \cos (n-1) \frac{\pi}{p}}$$

Taking *OU* as $\sqrt{2}E$, the value of *OZ* is seen, by inspection of figure 81, to be

$$\frac{\sqrt{2}E \sin n \frac{\pi}{p}}{n \sin \frac{\pi}{p}}$$

and substitution of these values in the expression just given results in

$$\tan \alpha = \frac{\sin \frac{n\pi}{p} \sin (n - 1)\frac{\pi}{p}}{n \sin \frac{\pi}{p} - \sin \frac{n\pi}{p} \cos (n - 1)\frac{\pi}{p}} \quad (33)$$

The angle α will change with load, but by large increments representing changes in the number of anodes which carry current simultaneously. Smaller variations in load do not affect α but adjustment of the circuit is obtained by a change in the time when an anode ceases to carry current which is a continuously variable quantity. Table VI shows the values of α under various conditions of operation.

TABLE VI

p	n	$\tan \alpha$	$\sin \alpha$	$\cos \alpha$	α
2	2	0	0	$\frac{1}{2}$	0 degrees
3	2	$\frac{1}{\sqrt{3}}$	$\frac{1}{2}$	$\frac{\sqrt{3}}{2}$	30 degrees
3	3	0	0	$\frac{1}{2}$	0 degrees
6	2	$\sqrt{3}$	$\frac{\sqrt{3}}{2}$	$\frac{1}{2}$	60 degrees
6	3	$\frac{\sqrt{3}}{2}$	$\frac{\sqrt{3}}{2}$	$\frac{2}{\sqrt{7}}$	40 degrees 54 minutes
6	4	$\frac{\sqrt{3}}{4}$	$\frac{\sqrt{3}}{4}$	$\frac{4}{\sqrt{19}}$	23 degrees 25 minutes
6	5	$\frac{\sqrt{3}}{11}$	$\frac{1}{2} \frac{\sqrt{3}}{\sqrt{31}}$	$\frac{11}{2\sqrt{31}}$	8 degrees 57 minutes
6	6	0	0	1	0 degrees

Voltage Wave Shapes When Current Is Carried Simultaneously by Several Anodes.

The voltage wave shapes which are obtained when several anodes carry current simultaneously are indicated in figure 82. Phase u will begin to carry current when its induced voltage is equal to the average induced voltage of the $n - 1$ phases which are already carrying current. At this point it has advanced by the angle α beyond the time

of zero voltage. The rectified voltage wave will then follow the average induced potential of the n phases (including u) until the leading phase of the group ceases to carry current, which occurs at the time represented by the angle β . The rectified voltage will then rise to that given by the average

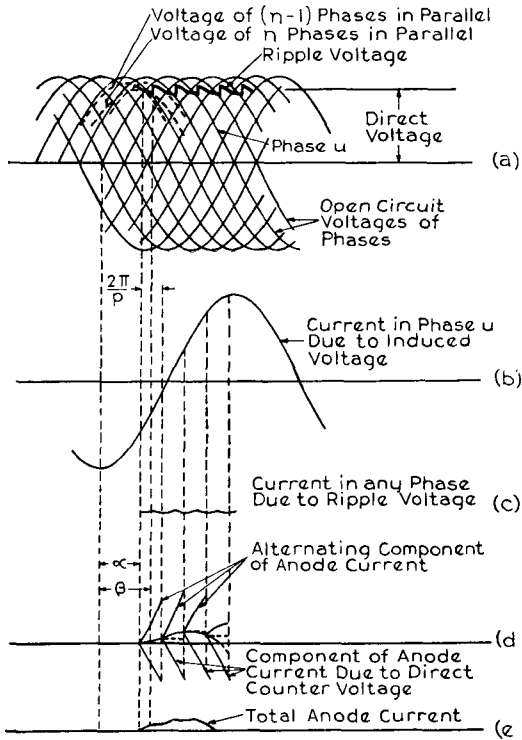

FIGURE 82.—Wave shapes obtained when several anodes carry current simultaneously.

of $n - 1$ phases, but this group will now contain phase u and the voltage therefore will not be a continuation of the former curve for $n - 1$ phases, but will be a repetition of it having a displacement of $\frac{2\pi}{p}$ where p is the number of phases. This curve will be followed until phase v which follows u becomes part of the conducting group, when the voltage will again be the average of the n anodes then carrying

current. The voltage impressed on any phase while it is conducting current consists, therefore, of the alternating voltage induced in the phase, the direct counter electromotive force, or output voltage, and the ripple voltage, a complete cycle of which is contained in an interval of $\frac{2\pi}{p}$.

Calculation of Anode-current Wave.

The alternating and direct voltages impressed on the phase will produce an alternating current with a lagging displacement of 90 degrees, a steady direct current representing the transient caused by starting the alternating current and a unidirectional current increasing regularly with time. These will be combined in the same manner as in the case of the battery charger. In addition, there will be a current through the phase due to the ripple component of the rectified voltage. This current will usually be quite small in magnitude and will have the same frequency as the ripple voltage.

The value of the output current can be calculated in several ways. An obvious method is to integrate the instantaneous value of the current to an anode over the period during which it carries current and multiply this by the factors required to give an average value. This involves, however, the integration of the ripple current which is quite awkward. A second method consists in calculating the sum of the currents carried by all the anodes at any instant. It is apparent that this is the instantaneous output current, but this current is constant; so the instantaneous value gives the desired result. This calculation can, moreover, be carried out without involving the ripple current. Assume that one anode is just beginning to conduct current. All other anodes carrying current will have been conducting for intervals which are multiples of $\frac{2\pi}{p}$. The average value of the ripple voltage for any such interval is zero; hence the currents at this time have a component due to the ripple voltage of zero magnitude.

Denoting the current to the anode just beginning to carry current by i_1 , and the currents to the anodes which precede it by $i_2, i_3, i_4 \dots i_n$ gives

$$i_1 = 0,$$

$$i_2 = i_1 + \frac{1}{L} \int_{\omega t = \alpha}^{\omega t = \alpha + \frac{2\pi}{p}} (\sqrt{2}E \sin \omega t - G) dt,$$

$$i_3 = i_2 + \frac{1}{L} \int_{\omega t = \alpha + \frac{2\pi}{p}}^{\omega t = \alpha + \frac{4\pi}{p}} (\sqrt{2}E \sin \omega t - G) dt,$$

$$i_4 = i_3 + \frac{1}{L} \int_{\omega t = \alpha + \frac{4\pi}{p}}^{\omega t = \alpha + \frac{6\pi}{p}} (\sqrt{2}E \sin \omega t - G) dt,$$

$$i_n = i_{n-1} + \frac{1}{L} \int_{\omega t = \alpha + (n-2)\frac{2\pi}{p}}^{\omega t = \alpha + (n-1)\frac{2\pi}{p}} (\sqrt{2}E \sin \omega t - G) dt,$$

$$J = i_1 + i_2 + i_3 + \dots + i_n,$$

$$= \frac{1}{\omega L} \sum_{k=1}^{k=n-1} (n-k) \int_{\alpha + (k-1)\frac{2\pi}{p}}^{\alpha + k\frac{2\pi}{p}} (\sqrt{2}E \sin \omega t - G) d(\omega t),$$

$$= \frac{1}{\omega L} \sum_{k=1}^{k=n-1} (n-k) [-\sqrt{2}E \cos \omega t - G\omega t]_{\omega t = \alpha + (k-1)\frac{2\pi}{p}}^{\omega t = \alpha + k\frac{2\pi}{p}},$$

$$= \frac{1}{\omega L} \sum_{k=1}^{k=n-1} (n-k) \left\{ \sqrt{2}E \cos \left(\alpha + (k-1)\frac{2\pi}{p} \right) - \sqrt{2}E \cos \left(\alpha + k\frac{2\pi}{p} \right) - G\frac{2\pi}{p} \right\},$$

$$JX = \sum_{k=1}^{k=n-1} (n-k) \left\{ 2\sqrt{2}E \sin \left(\alpha + \frac{(2k-1)\pi}{p} \right) \sin \frac{\pi}{p} \right\} - \frac{2\pi n(n-1)}{p} \frac{G}{2}. \quad (34)$$

Figure 82*d* illustrates graphically the manner in which the anode currents are calculated and why each current can be expressed in a way involving those which have not flowed for so long a time. The components due to the ripple

voltage are not shown in this case. They are very small, but would give the current wave an appearance as in figure 82*e*.

Prestarting of Anodes.

It is possible for an anode to enter the conducting group, leave it after a short interval, and then return to it for a longer period. The manner in which this occurs is shown in figure 83. Previous to the point *A*, phases *r*, *s*, and *t* have been carrying the load between them and the rectified

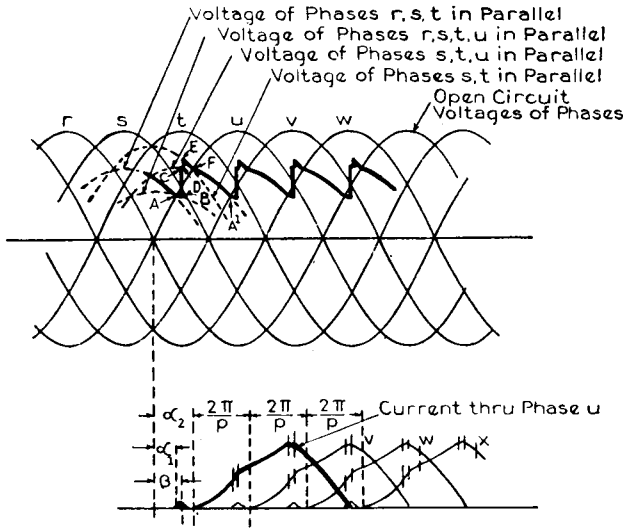

FIGURE 83.—Wave shapes with prestarting of anode currents.

voltage is their average induced potential. At *A* the voltage of phase *u* becomes equal to this and phases *r*, *s*, *t*, and *u* then carry current. At *B* phase *r* ceases to carry current, and the rectified voltage rises to average induced potential of phases *s*, *t*, and *u*, as shown at *C*. The potential of phase *u* is now lower than that of the group and it loses its current and ceases to have any at *D*. The rectified voltage then rises to the value corresponding to phases *s* and *t* at *E* and follows this wave until phase *u* again enters the group at *F*. Beyond this point, the rectified voltage is given by

the value corresponding to phases *s*, *t*, and *u*. At *A'*, phase *v* starts to enter the conducting group; hence, *AA'* is a complete cycle.

This phenomenon causes additional irregularities in the anode-current wave, but the same equation (34) still holds for the output current provided *n* is taken to represent the number of anodes carrying current after the incoming anode has entered the group for the second time. This is so

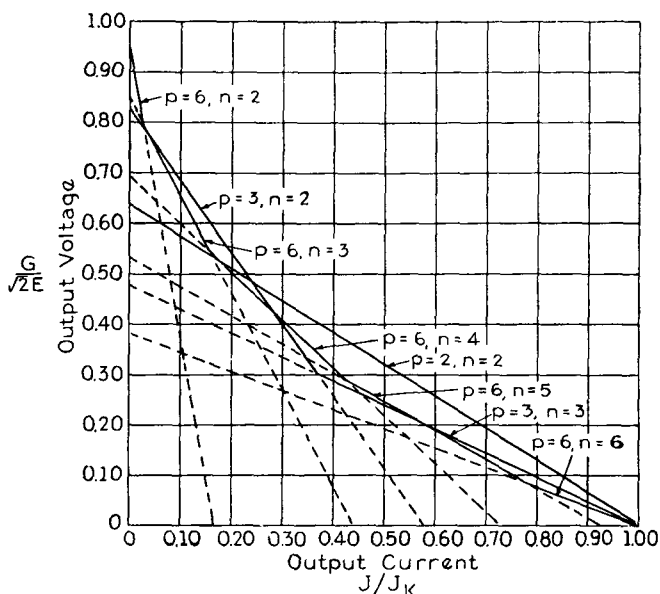

FIGURE 84.—Regulation curves of rectifiers in which the reactance may be considered as though lumped in the anode leads.

because the currents calculated for the anodes working inside the main portion of the wave will then be taken into account in the same manner as before, and the smaller portion of the current wave is so located that no anode will be carrying such a current at the instant assumed for the calculations.

Regulation Curve from No Load to Short-circuit.

The regulation curves of several rectifiers are shown in figure 84. It will be seen that they consist of a number of

straight lines, each representing a different number of anodes carrying current simultaneously. The equations for these lines, which are given in Table VII, are obtained by substituting the proper values of n , p and α in equation (34). Transition between sections is accomplished through the phenomenon of prestarting. Consider a rectifier operating alternately with n and $n - 1$ phases. As the load is decreased, the point at which the phases drop out of the

TABLE VII

$p = 2, n = 2$	$\frac{G}{\sqrt{2}E} = \frac{2}{\pi} \left[1 - \frac{J}{J_K} \right]$
$p = 3, n = 2$	$\frac{G}{\sqrt{2}E} = \frac{3\sqrt{3}}{2\pi} \left[1 - \sqrt{3} \frac{J}{J_K} \right]$
$p = 3, n = 3$	$\frac{G}{\sqrt{2}E} = \frac{3}{2\pi} \left[1 - \frac{J}{J_K} \right]$
$p = 6, n = 2$	$\frac{G}{\sqrt{2}E} = \frac{3}{\pi} \left[1 - 6 \frac{J}{J_K} \right]$
$p = 6, n = 3$	$\frac{G}{\sqrt{2}E} = \frac{\sqrt{7}}{\pi} \left[1 - \frac{6}{\sqrt{7}} \frac{J}{J_K} \right]$
$p = 6, n = 4$	$\frac{G}{\sqrt{2}E} = \frac{\sqrt{19}}{2\pi} \left[1 - \frac{6}{\sqrt{19}} \frac{J}{J_K} \right]$
$p = 6, n = 5$	$\frac{G}{\sqrt{2}E} = \frac{3\sqrt{31}}{10\pi} \left[1 - \frac{6}{\sqrt{31}} \frac{J}{J_K} \right]$
$p = 6, n = 6$	$\frac{G}{\sqrt{2}E} = \frac{6}{5\pi} \left[1 - \frac{J}{J_K} \right]$

conducting group will advance in time. Soon the condition will be reached where the induced voltage of the incoming phase is less than the average of the remainder of the group after the outgoing phase has been dropped. Under these conditions the incoming phase will lose some of the current it has acquired, and then regain it as its potential increases. If the load be further decreased, the incoming anode will finally lose so much current that the wave will be depressed to zero before commencing to increase again. This is the transition point. For higher loads, operation is with n and $n - 1$ anodes. For lower loads, the current wave will consist of two portions, and the regulation curve is that corresponding to operation with $n - 1$ and $n - 2$ anodes.

With only one and two anodes operating simultaneously, it would appear that equation (34) might not be applicable because of the period in which the current is held at a constant value by the direct-current choke. This is not so, however, for the choke holds the current constant by means of a voltage which it supplies, and this is part of the ripple voltage which is fully considered in the calculations. Therefore, the expressions derived by special means for this limited case should be the same as those given by the more general equation, and this is true.

Alternate Solution for Regulation Curves.

The straight-line regulation curves given by equation (34) can also be derived graphically by making use of the observation that the ripple currents can be dropped if measurements are made at intervals of $\frac{2\pi}{p}$ from a time when the ripple current was zero as it is at the instant when current starts to an anode. Equation (34) was worked out by adding i_1 , i_2 , etc., representing the various anode currents at one instant. The same result would have followed had all the values of one anode current for intervals of $\frac{2\pi}{p}$ been added. One anode current without the ripple component is the sum of two factors, as shown in figure 82. Figure 85 shows the two components drawn to a larger scale with the slope of the current due to counter electromotive force reversed so that the points of intersection will represent points of zero anode current and the difference at $\frac{2\pi}{p}$ intervals will represent anode current. The various times when current can start, as determined in Table VI, are indicated at α_1 , α_2 . . . Suppose $i_d = \frac{G}{X} \omega t$, the current due to counter electromotive force, be drawn through i_a , the alternating component, at α_2 corresponding to two anodes carrying current when a third cuts in. The output voltage is inherent in the slope of the

line i_a . The current J is the sum of j_3 which is zero and j_2 and j_1 measured at intervals of $\frac{2\pi}{p}$ from α_2 . From the diagram, j_2 and j_1 will increase linearly as G is reduced. A straight-line regulation must then exist, the equation for which can be deduced by evaluating the graphic solution. Similarly a new line i_a can be drawn intersecting i_a at one of the other possible current starting points α_n ; m different values of j measured at intervals of $\frac{2\pi}{p}$ will then increase linearly with decrease of G and a corresponding straight line will result. The straight lines obtained will,

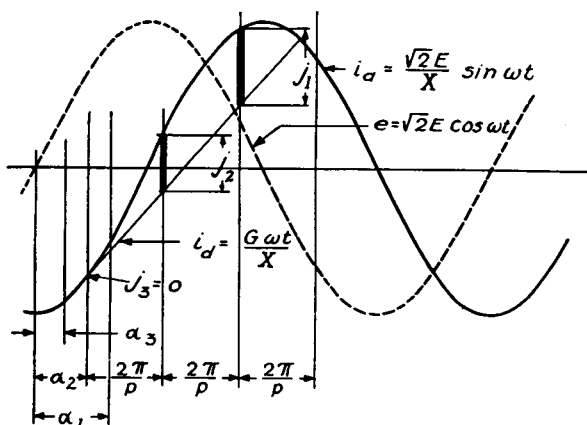

FIGURE 85.

of course, be the same straight lines given by equation (34). Since by inspection the lines are straight, they can be obtained by scaling an accurate drawing for two arbitrary points or by calculating two arbitrary points from the geometry of the figure. These straight lines are indefinite in extent but at any load the line giving the highest output voltage will be the one to be considered.

Correction for Arc-drop and Resistance Losses.

Since the arc-drop has been found to be substantially constant, it may be considered to have the effect of a steady voltage on the secondary windings while they are

carrying current, and by deducting the arc-drop from the output voltage, a correction of the latter for the error due to this cause is easily obtained. The error caused by neglecting the resistance of the transformer windings is not so readily eliminated, for the resistance losses cause a change in the wave shapes which cannot be explained by

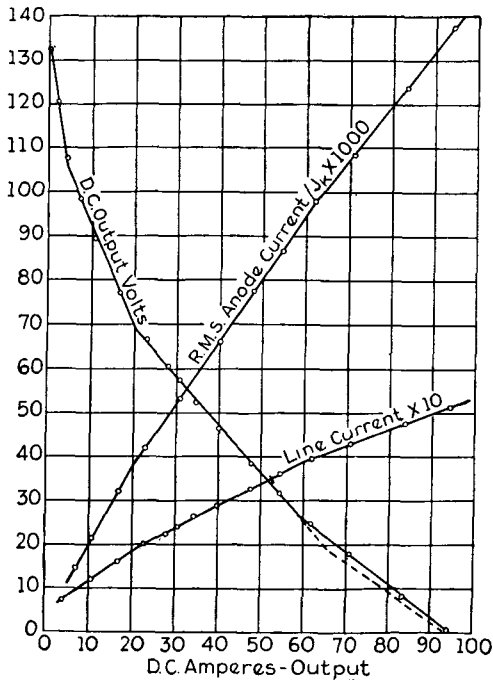

FIGURE 86.—Experimental regulation curve of a six-phase rectifier circuit with reactances in the anode leads. Calculated short-circuit output current, neglecting arc-drop and resistance losses, 152.6 amperes. Secondary voltage, 110. Dotted line shows calculated output voltage.

considering the voltage drops as part of another simple voltage. A correction which is quite satisfactory in most cases, however, consists of the calculation of all the resistance losses and the reduction of the output voltage by an amount equal to this loss divided by the output current. This method would be absolutely accurate if sine waves of current at unity power factor were carried by the transformer, for the wave shapes would then be unaffected

by the resistance; the relative magnitudes alone suffering from the effect of the resistance.

Figure 86 shows calculated and experimental regulation curves for a small six-phase rectifier with reactance lumped

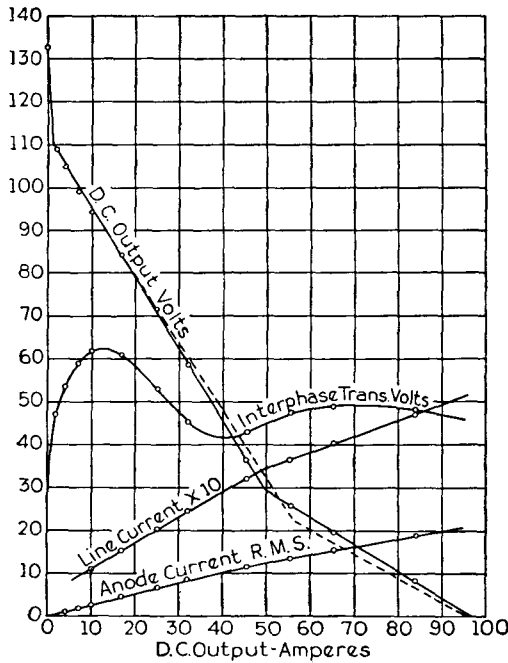

FIGURE 87.—Experimental regulation curve of a double three-phase rectifier with reactances in the anode leads. Calculated short-circuit output current, neglecting arc-drop and resistance losses, 152.6 amperes. Secondary voltage, 110. Dotted line shows calculated output voltage.

in the anode leads. The calculated curve is corrected for resistance and arc-drop losses. Figure 87 shows similar curves for operation of a double three-phase rectifier circuit using the same reactances.

CHAPTER X

REGULATION OF DOUBLE THREE-PHASE RECTIFIERS WITH REACTANCE IN THE PRIMARIES OR SUPPLY LINES

If two three-phase rectifiers are combined to make a double three-phase rectifier, the regulation will not be changed for the case where all the reactance may be considered as in the anode leads. For the more usual case, however, in which the reactance is in the transformer primaries or supply lines the initial slope of the regulation curve is halved when the output current is expressed in terms of the nominal short-circuit current because the coupling between phases which exists under the conditions of a polyphase alternating-current short-circuit is avoided by the commutating currents. Hence, they meet only one-half the effective reactance per phase that is presented to the currents of a complete short-circuit.

As long as the lap angle u is less than 60 degrees, the total time during which current flows to one anode is less than 180 degrees, and there will be no time during which the two anodes fed from the same phase will draw current simultaneously. As long as this condition is met there will be no interference between the groups of phases and the regulation will be given by

$$G = G_0 \left(1 - \frac{\sqrt{3}}{2} \frac{J}{J_k} \right)$$

for the case where all the reactance is in the primary windings or supply lines, as indicated in Table Vc.

If the period of commutation is 60 degrees, the period during which each anode carries a steady current will be found to be 60 degrees also. Under these circumstances one phase will be carrying a steady current in one group

while two other phases are being commutated in the second group; and the phase which is carrying the steady current is on a different transformer leg from the other two and can therefore suffer no reactive drop. The potentials of the idle phases on the same transformer legs as those being commutated will be affected by the reactive drops, but it will be found that the resultant potentials must be less than those of the phases carrying current so that the current distribution will not be influenced. This point will be illustrated later when the various wave shapes are developed.

Voltage Rise under Very Light Loads.

If the load on the rectifier is very light, consisting only of a voltmeter or some pilot lamps, the output current will be less than the exciting current of the interphase transformer and the latter will be unable to hold the two groups in electrical separation. Operation will then be as a six-phase rectifier with the exciting reactance of the interphase transformer slowing the rate of transfer of current between anodes. An anode carrying current in one group will be followed by an anode in the other group.

The regulation under these conditions is found by equation (17) for a six-phase rectifier, adding the exciting reactance of one-half the interphase transformer to the reactance of one phase. The exciting reactance is usually so high by comparison that the line or primary reactance can be neglected in this calculation.

The resultant rise of voltage under very light loads is shown by figure 87. Before a 2-ampere output is reached the voltage has fallen to the normal three-phase value. In practice it is a simple matter to avoid this unusual potential by arranging to have some of the auxiliary apparatus always connected in the output circuit.

Regulation under Very Heavy Loads.

With transformers of normal reactance, full-load current will be reached with only a relatively small voltage drop. It is usually found that the range of normal loadings does

not run to the point where an anode begins to carry current while the two preceding anodes are still active, or where the commutation of two anodes affects the voltage of others which should be carrying current. This makes it a simple matter to obtain regulation data for ordinary use, as given in Table Vc. Conditions may arise, however, requiring a knowledge of the regulation curve well out toward short-circuit with rectifiers which cannot be treated as though their reactance were lumped in the anode leads. If only ordinary short-circuit data are desired, they can usually be obtained with sufficient accuracy if regulation curves are available for the cases where the reactance is assumed lumped in the primary windings or supply lines, even though it is actually distributed. It may be desired to build a rectifier with something approaching constant-current characteristics, and in this case the reactance will probably be so arranged that it can even more correctly be considered as though lumped in either the primary windings or supply lines.

Double Three-phase Rectifier with Primary Reactance.

In dealing with the regulation of rectifiers beyond the initial straight line the method to be pursued will be first to explain the wave shapes obtained and then to apply analytical methods to fix quantitatively the connection between wave shapes and output current-voltage relations.

Figure 88 shows a double three-phase rectifier with delta-connected primary, having all the reactance in the primary windings.

Under light loads the voltage and current wave shapes will be as shown in figure 89. If for one group of three phases the positive direction of voltage is taken as up, and for the other three the positive direction is taken as down, all six anode voltages are shown, each trace representing two. This is possible because all reactive drops are common to the secondaries which are wound on one leg of the transformer. This state of affairs does not affect the regulation, however, for while the voltage of one secondary

is altered by the commutation of the current in the other secondary on the same leg, commutation occurs at times when one secondary is not carrying current. Hence, under light loads the current wave shapes will not differ from those obtained with all the reactance lumped in the secondary windings, and the presence of additional notches in the potential waves occurring while no current flows will not affect the output voltage or current.

These conditions will hold until the period of commutation becomes equal to 60 degrees, as shown in figure 90. A phase then receives the load current from the preceding phase in the same group during a 60-degree period of commutation, carries this current alone for a second period of 60 degrees, and loses it during another 60-degree period by transfer to the following phase. Immediately before any phase starts to carry current, its mate on the same transformer leg is losing its current by transfer to another phase, and, therefore, is at a potential higher than its open-circuit voltage. The potential of the incoming phase is correspondingly depressed so that not until the instant that it should begin to carry current does the new phase acquire a potential equal to that of the phase in the same group which is already carrying current. Up to this time its potential has been held down by the commutation of its mate in the other group and this is not completed until the instant when the phase under consideration needs the voltage in order to receive the load.

It is apparent that the above arrangement represents the greatest load which can be carried without a marked change in the wave shapes. For smaller loads commutation starts at the same point in the cycle regardless of load, and the period of commutation increases with load. The period of commutation cannot very well increase beyond 60 degrees, however, for this would mean that one phase would have to start conducting current before its mate in the other group ceased, and this in turn means that both would have to be simultaneously positive, whereas the common inductance makes the potentials of mate phases equal and opposite. Instead

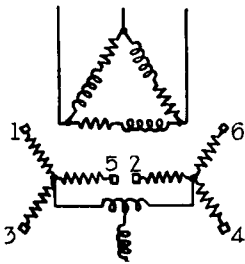

FIGURE 88.

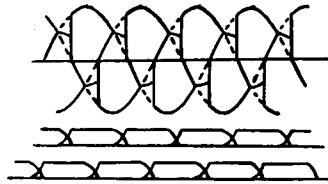

FIGURE 89.

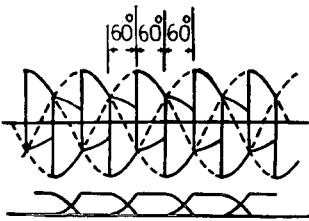

FIGURE 90.

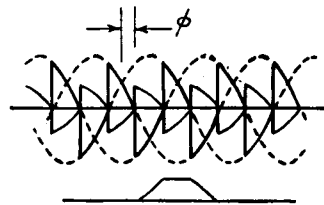

FIGURE 91.

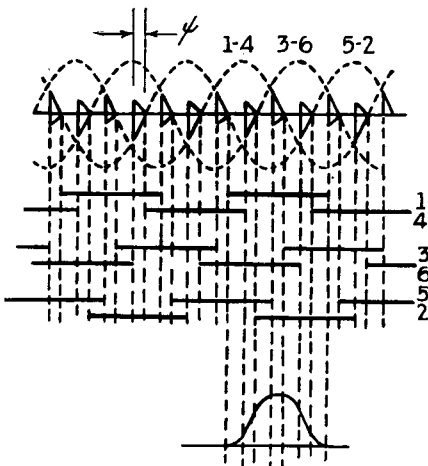

FIGURE 92.

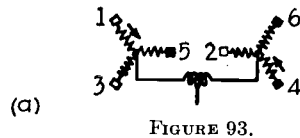

FIGURE 93.

(a)

(b)

(c)

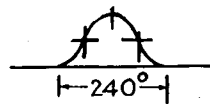

FIGURE 94.

FIGURES 88 to 94.—Double three-phase circuit with reactance in delta-connected primaries and resultant wave forms.

the period of commutation remains fixed at 60 degrees and for greater loads a phase does not begin to carry current until later in the cycle. This angle of delay in starting increases with the load until it reaches a value of 30 degrees.

Figure 91 shows the voltage and current waves under this condition. It appears that at two points the voltage of a conducting phase becomes zero for an instant. At the same time the potentials of the phases not carrying current have risen to this value. This sets the limit on the increase of the angle of delay. It is necessary to look for still another mechanism to carry the wave shapes to short-circuit. This is accomplished by holding the angle at which an anode starts conducting current at the value given by figure 91 and making further increases in load by increasing the period during which an anode carries current. Two windings on the same transformer leg will now carry current simultaneously, which is found to be possible, for a short-circuit ensues during the time the two windings are simultaneously conducting and all phases have the same voltage, namely, zero. Figures 92 and 93 indicate the operation under these conditions.

Figure 92 shows the voltage waves at *a*, the voltages of phases 4, 6, and 2 being shown reversed for simplicity. The periods during which the different phases carry current are indicated by the horizontal lines at *b*, and the current wave shape for anode 1 is shown at *c*.

Figure 93 shows the manner in which the phases are short-circuited during part of the cycle. Consider a time just previous to the instant when phase 1 commences to carry current. Phases 4 and 6 in one group and phase 5 in the other group are conducting current. The potential of phase 1 is negative, for it is equal and opposite to that of phase 4 which is carrying current in the other group in conjunction with phase 6, and the voltage of phases 4 and 6 is positive. As the voltage of phases 4 and 6 falls toward zero, that of phase 1 approaches zero from its negative value. Phase 5 is positive and also approaching zero voltage. All the phases reach zero voltage at the same

instant and this is the time when phase 1 begins to carry current. With the additional phase carrying current, the voltages do not change as before but a short-circuit occurs which allows the entire voltage impressed on the primary windings to be absorbed by their reactance.

Since only two phases in each group are conducting current during the short-circuit, it is not immediately apparent that this short-circuit is complete. Figure 93 explains this point. Phases 5, 4, and 6 are secondaries of all three primary windings and, if these three phases are allowed to carry unrestricted currents, the short-circuit certainly exists. Before phase 1 becomes conducting, the current to phase 5 cannot change because of the inductance in load and interphase transformer. As soon as phase 1 becomes conducting, however, the variable portion of the current which leaves anode 5 may be considered to enter phase 1 with an equal and opposite current to that entering phase 4, in addition to its normal current. This extra current meets no impedance because the equal changes in phases 1 and 4 neutralize each other and do not flow in the primary. In the right-hand group the following currents may then be considered as flowing through the three windings: the normal short-circuit current of phase 6, the normal short-circuit current of phase 4, and the normal short-circuit current of phase 5 reversed, entering through phase 4. These three variable currents will be in addition to steady currents carried by the windings. They will be 120 degrees apart in phase and their sum will be constant, a requirement which must be met on account of the direct-current choke system. In the left-hand group, phase 1 will carry the variable current of phase 5 reversed, thus making the sum of the currents in this group constant.

The short-circuit will last until the variable current in some anode cuts the total current of that anode to zero by becoming equal in value to the steady current and of opposite sign. This anode will then cease to carry current, and the complete short-circuit will be interrupted. Since anode 1 enters the conducting group with no steady

current, it is necessary that the variable current to be carried by it is not decreasing in value at this time. It is interesting to notice that the current of phase 5 reaches a maximum and reverses its rate of change at the time phase 1 becomes conducting, and that this allows the current in phase 1 to be an increasing current.

As the direct current in the output circuit increases, the periods of temporary short-circuit gradually increase until finally there is no output voltage and a continuous short-circuit prevails. The anode-current waves will then be as shown in figure 94. Current flows for 240 degrees, and the wave may be divided into four 60-degree sections, each representing portions of sine waves of equal magnitude, these portions always lying between the maximum or minimum value and 60 degrees to one side. Other wave shapes might be shown which satisfy the requirements at short-circuit, because, as the secondaries have no reactance or resistance, there is in theory nothing to fix the current definitely. The wave shape shown in figure 94, however, is the limit approached as the load approaches short-circuit, and is therefore the correct one. This point is covered by actual test in the oscillogram shown in figure 105.

Double Three-phase Rectifier with Line Reactance.

Two other rectifier circuits give the same wave forms as those just discussed. One of these is shown in figure 95. In this case the reactance is in the supply lines instead of in the primary windings. The commutating currents are shown in figure 95, and it is seen that commutation of current between two phases affects the voltages of only those phases and the two on the same transformer legs, as in the primary-reactance case. The voltages of the other two phases are not disturbed. In addition, the voltages of the phases which are affected will be found to be the average as before. The secondary voltage and current waves will, therefore, be the same as those already discussed until the case where temporary short-circuits occur. In this case, also, the short-circuit currents will

be found to have the same phase relations and the correct magnitude, so that the similarity holds throughout the entire range. Proof that the relative magnitudes of the currents are correct will be deferred until the calculation of the regulation curves.

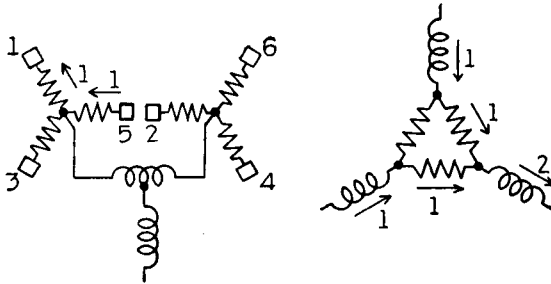

FIGURE 95.

Double Three-phase Rectifier with Transformer Having Y-connected Primary Containing the Reactance and Impedanceless Tertiary Winding.

This is the third case which gives the same wave forms. The arrangement of the circuit is shown in figure 96. Commutation is accomplished by a current flowing in the windings to be commutated and equivalent and opposite

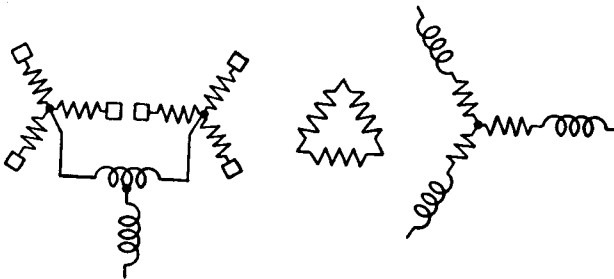

FIGURE 96.

currents flowing in the corresponding primary windings. The voltage of the phases on the third transformer leg is not disturbed. The short-circuit currents will have the same phase as before. The magnitudes of all the currents for the three different cases will be calculated later and

shown to be equal when expressed in terms of the short-circuit current on the usual alternating-current load. This means that all three cases will have the same regulation curve.

It will be noticed that in this case the tertiary winding does not carry any current. It, therefore, has no function except that of circulating the third harmonic of the exciting current of the transformers, a service required wherever Y-connected primaries are to be used without distortion of the secondary voltage waves.

Calculation of Regulation Curve of Double Three-phase Rectifier with Primary Reactance.

The direct output voltage at no load, as given by equation (6), is

$$G_0 = \sqrt{2}E_2 \frac{3}{\pi} \sin \frac{\pi}{3} = 0.827\sqrt{2}E_2. \quad (35)$$

The regulation curve starts as a straight line and continues as such until the period of commutation is 60 degrees. At this point, the output voltage is three-fourths of its no-load value, for, by inspection of figure 90, it is seen that the potential of a group while two phases are being commutated is one-half the potential of the group 60 degrees later when the current is carried by a single phase. This results in the average value given. At this point, then

$$G_1 = 0.620\sqrt{2}E_2. \quad (36)$$

Throughout this section of the curve, the impedance presented to the commutating currents is $2X_1 \left(\frac{E_2}{E_1}\right)^2$ where X_1 is the reactance in each primary circuit, E_1 is the nominal primary voltage, and E_2 is the nominal voltage of each secondary. The commutating voltage is $\sqrt{3}E_2$ and the output current per group can be determined by finding the current which is commutated by this voltage in the 60-degree interval. It is

$$\frac{1}{2}J_1 = \frac{\sqrt{2}\sqrt{3}E_2}{2X_1} \left(\frac{E_1}{E_2}\right)^2 (\sin 90^\circ - \sin 30^\circ) = \frac{\sqrt{3}E_1^2}{2\sqrt{2}X_1E_2}$$

where J_1 is the total output current at this point. Therefore,

$$J_1 = \frac{\sqrt{3}}{\sqrt{2}} \frac{E_1^2}{X_1 E_2}. \quad (37)$$

Figure 90, while primarily representing conditions at the end of the first straight-line section of the regulation curve, must also indicate the wave shapes at the start of the next section which will be shown to be elliptical. Figure 91 shows the conditions at the end of this section. It will be noticed that throughout the section the voltage wave of each group may be divided into 60-degree intervals, and that the wave shape is the same in each interval except that it has twice the magnitude in those intervals which represent conduction by one anode that it has in those intervals representing conduction by two anodes.

Let ϕ be the angle of delay in the starting of any anode referred to the conditions in figure 90. This angle will then be zero in figure 90, and by the time the load has increased to give the conditions shown in figure 91 it will have attained a value of 30 degrees. The direct voltage will be three-fourths of the average value of the instantaneous voltage over one of the 60-degree periods when only one anode is carrying current or

$$\begin{aligned} G &= \frac{3}{4} \cdot \frac{3}{\pi} \sqrt{2} E_2 \int_{\phi}^{\phi+60^\circ} \cos \theta d\theta, \\ &= \frac{9\sqrt{2}E_2}{4\pi} \{ \sin(\phi + 60^\circ) - \sin \phi \} \\ &= \frac{9\sqrt{2}E_2}{4\pi} \left\{ \frac{\sqrt{3}}{2} \cos \phi + \frac{1}{2} \sin \phi - \sin \phi \right\}, \\ &= \frac{9\sqrt{2}E_2}{4\pi} \cos(30^\circ + \phi). \end{aligned} \quad (38)$$

The current per group can be determined in the same manner as before if allowance is made for the difference in phase of the commutating voltage. It will be

$$\frac{J}{2} = \frac{\sqrt{2}\sqrt{3}E_2}{2X_1} \left(\frac{E_1}{E_2} \right)^2 \{ \cos \phi - \cos(\phi + 60^\circ) \},$$

$$\begin{aligned}
 &= \frac{\sqrt{2}\sqrt{3}E_1^2}{2X_1E_2} \left\{ \cos \phi - \frac{1}{2} \cos \phi + \frac{\sqrt{3}}{2} \sin \phi \right\}, \\
 &= \frac{\sqrt{2}\sqrt{3}E_1^2}{2X_1E_2} \sin (30^\circ + \phi).
 \end{aligned}$$

And the output current will be

$$J = \frac{\sqrt{2}\sqrt{3}E_1^2}{X_1E_2} \sin (30^\circ + \phi). \quad (39)$$

Since J and G are, respectively, sine and cosine functions of the same variable, this section will be elliptical. The axes of the ellipse correspond to the J and G axes, and their half lengths are

$$\frac{\sqrt{2}\sqrt{3}E_1^2}{X_1E_2} \quad \text{and} \quad \frac{9\sqrt{2}E_2}{4\pi}, \text{ respectively.}$$

It has been seen that, in the third and final section of the regulation curve, the current always starts to flow at the same point in the cycle but continues for a longer time as the load is increased. This increase in period of flow results in recurring temporary short-circuits. Let the duration of these short-circuit periods be represented by the angle $(60^\circ - \psi)$ which makes the lengths of the unaffected periods equal to ψ . The voltage wave forms are indicated in figure 92 and are the same as those shown in figure 91 representing the end of the elliptical section except that now there is no voltage during the periods of temporary short-circuit. The output voltage will be given by

$$G = \frac{3}{4} \cdot \frac{3\sqrt{2}E_2}{\pi} \int_0^\psi \sin \theta d\theta = \frac{9\sqrt{2}E_2}{4\pi} (1 - \cos \psi). \quad (40)$$

The output current can be determined by calculating the value of the anode current at an instant when one anode is carrying the entire current for the group in which it is located. In figure 92c this time is indicated by the flat spot on the top of the current wave. This wave is for anode 1 and before the portion under discussion is reached, the anode passes through two temporary short-circuits and one period during which it operates in parallel with anode

5. During the first temporary short-circuit it carries the full short-circuit current of anode 5 reversed and thereby receives an increment of $\frac{\sqrt{2}E_1^2}{X_1E_2} \{ \sin 90^\circ - \sin (30^\circ + \psi) \}$.

During the second short-circuit period it carries its own short-circuit current. This increases it by

$$\frac{\sqrt{2}E_1^2}{X_1E_2} \{ \sin (90^\circ - \psi) - \sin 30^\circ \}.$$

In the interval between these two temporary complete short-circuits it is operating in parallel with phase 5 and the increment during this period is due to the interchange of current between phases 1 and 5. The voltage per phase available for this interchange is half the voltage between phases, or $\frac{\sqrt{3}}{2}E_2$, and it has a maximum instantaneous value at the close of the period. The increase in anode current during this period is, therefore,

$$\frac{\sqrt{3}\sqrt{2}E_1^2}{2X_1E_2} \sin \psi.$$

Adding these three increments together results in

$$\begin{aligned} \frac{J}{2} &= \frac{\sqrt{2}E_1^2}{X_1E_2} \left\{ 1 - \sin (30^\circ + \psi) + \cos \psi - \frac{1}{2} + \frac{\sqrt{3}}{2} \sin \psi \right\}, \\ &= \frac{\sqrt{2}E_1^2}{X_1E_2} \left\{ \frac{1}{2} + \frac{1}{2} \cos \psi \right\}, \end{aligned}$$

or

$$J = \frac{\sqrt{2}E_1^2}{X_1E_2} \{ 1 + \cos \psi \}. \quad (41)$$

Examination of equations (40) and (41) indicates that the final section of the regulation curve is a straight line since both G and J are linear functions of $\cos \psi$.

The complete regulation curve is shown in figure 97. The currents are expressed in terms of J_K where J_K is the nominal short-circuit output current defined as $\sqrt{2}pI_K$ and I_K is the alternating short-circuit current of each secondary winding with a short-circuit involving all phases.

It now remains to be proved that identical regulation curves are obtained with reactance in the supply lines or with reactance in Y-connected primary windings, using a tertiary winding in the last case to avoid excitation diffi-

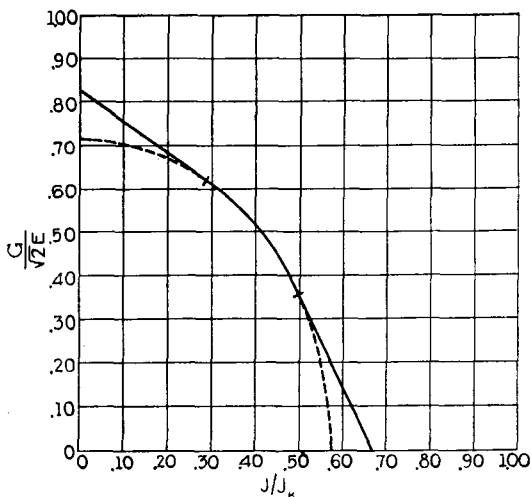

FIGURE 97.—Regulation curve of double three-phase rectifier circuits with reactance in the primaries or supply lines.

TABLE VIII

COMPARISON OF CURRENT COMPONENTS, DOUBLE THREE-PHASE RECTIFIERS

	Reactance in delta-connected primaries	Reactance in supply lines (primary delta connected)	Reactance in star-connected primaries
Commutating current for two otherwise unconnected phases (root-mean-square).	$\frac{\sqrt{3}E_1^2}{2X_1E_2}$	$\frac{E_1^2}{2\sqrt{3}X_L E_2}$	$\frac{\sqrt{3}E_1^2}{2X_1E_2}$ *
Alternating components of temporary short-circuit current (root-mean-square) (equivalent to short-circuit of three phases).	$\frac{E_1^2}{X_1E_2}$	$\frac{E_1^2}{3X_L E_2}$	$\frac{E_1^2}{X_1E_2}$
Alternating short-circuit current (root-mean-square) per phase for all six phases short-circuited.	$\frac{E_1^2}{2X_1E_2}$	$\frac{E_1^2}{6X_L E_2}$	$\frac{E_1^2}{2X_1E_2}$

* E_1 is taken as the voltage to neutral when the primaries are connected in Y.

culties. It has already been shown that the wave shapes obtained in the three different cases are of the same nature, and, in order to prove that the regulation curves are the same, it is only necessary to calculate the commutating and short-circuit currents in the three cases and compare them. This is done in Table VIII, and it is seen that the currents in every case are in the same ratio.

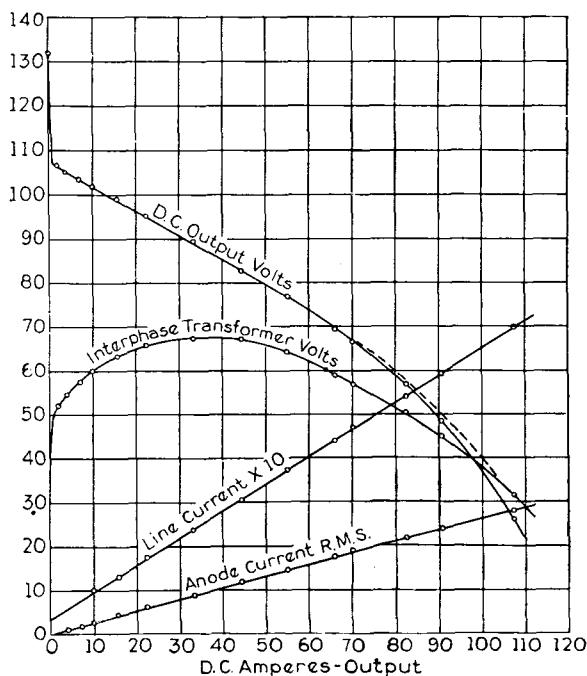

FIGURE 98.—Experimental regulation curve of a double three-phase rectifier circuit with reactances in series with the transformer primaries. Calculated short-circuit output current, neglecting arc-drop and resistance losses, 143.3 amperes. Dotted line shows calculated output voltage. Nominal secondary voltage, 110. Primary windings connected in delta.

Reactance in Both Primary-connected Delta and Supply Lines.

Not only will reactance lumped in either the primary delta or supply lines result in identical regulation curves, but reactance distributed between them will also give the

same characteristics. Distribution of the reactance does not affect the nature of the secondary wave shapes, and the commutating and short-circuit currents will be found to retain the same ratio. The root-mean-square value of the commutating current is $\frac{\sqrt{3}E_1^2}{2(3X_L + X_1)E_2}$ and the

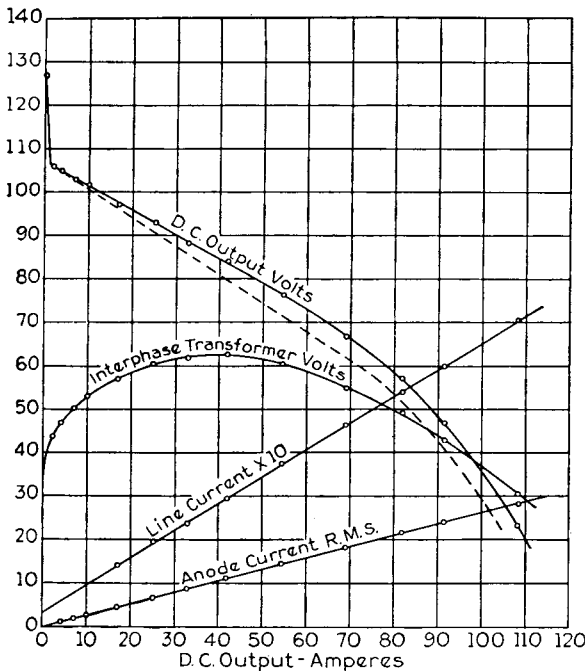

FIGURE 99.—Experimental regulation curve of a double three-phase rectifier circuit with reactances in the supply lines. Calculated short-circuit output current, neglecting arc-drop and resistance losses, 139 amperes. Dotted line shows calculated output voltage. Nominal secondary voltage, 110. Primary windings connected in delta.

root-mean-square value of the temporary short-circuit currents is $\frac{E_1^2}{(3X_L + X_1)E_2}$. The root-mean-square value of the alternating current on complete short-circuit is $\frac{E_1^2}{2(3X_L + X_1)E_2}$.

Experimental Regulation Curves.

Figures 98 and 99 show experimental regulation curves obtained with reactance lumped in the primaries and in the supply lines. The wave shapes are shown in figures 100 to 110, inclusive.

The calculated output voltages were corrected for resistance losses by deducting the quotient of the total power lost in resistances and arc-drop divided by the output current.

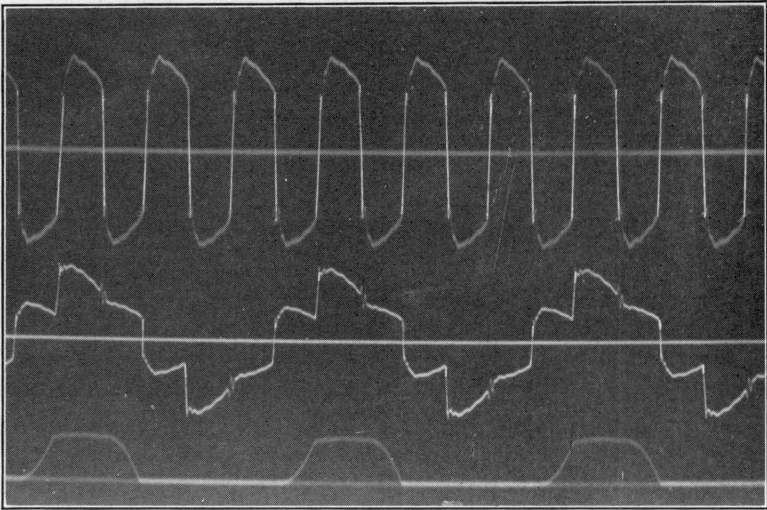

FIGURE 100.— $\frac{J}{J_K} = 0.19$, (in first straight line).

FIGURES 100 to 105.—Wave shapes of an experimental double three-phase rectifier circuit with reactances in series with the transformer primaries. Calculated short-circuit output current, 148 amperes, corresponding to $J_K = 222$ amperes. Nominal secondary voltage, 110 volts. In figures 100 to 102 the upper trace shows the interphase transformer voltage. In figures 103 to 105 the upper trace shows the line current. In all figures the central and lower traces show secondary voltage and current to the corresponding anode. For the higher currents a small direct voltage was applied in the output circuit to overcome arc-drop and resistance losses.

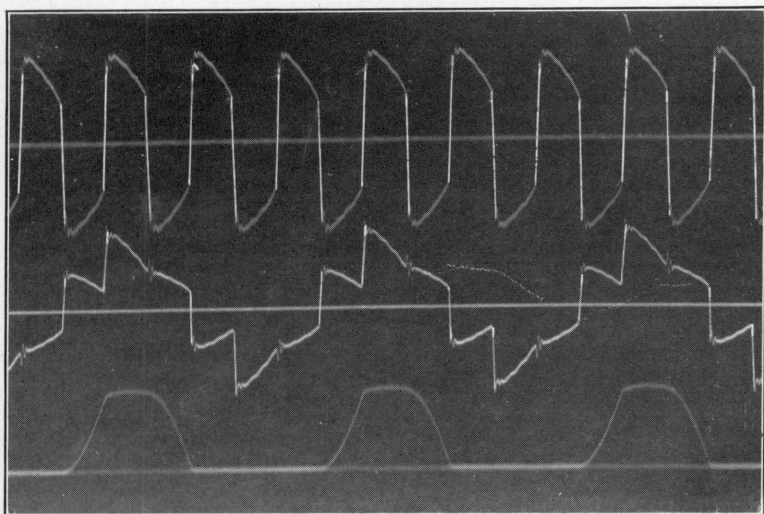

FIGURE 101.— $\frac{J}{J_K} = 0.33$, (near first transition point).

(See general title on page 170)

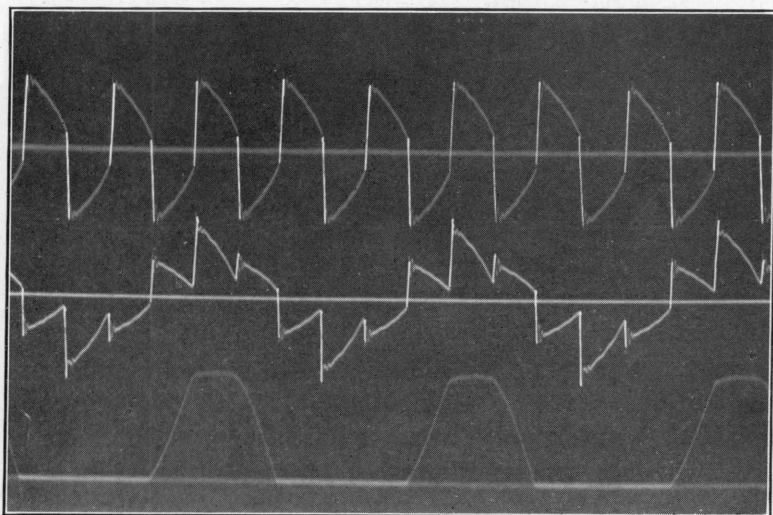

FIGURE 102.— $\frac{J}{J_K} = 0.45$, (in ellipse).

(See general title on page 170)

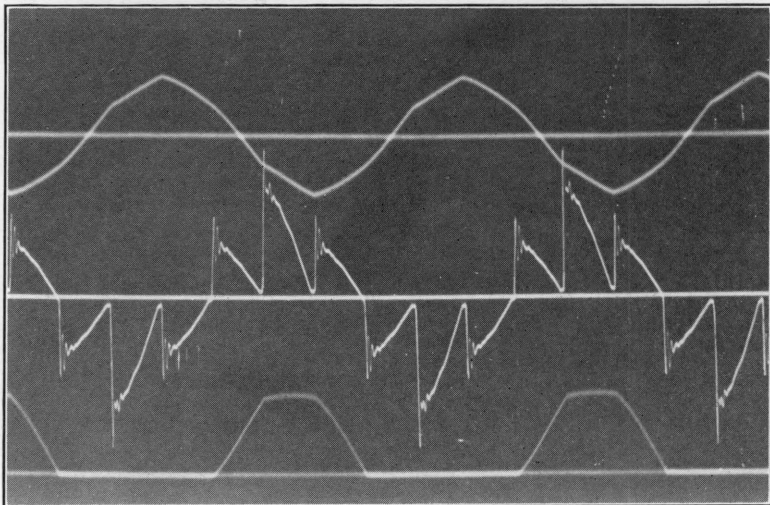

FIGURE 103.— $\frac{J}{J_K} = 0.50$, (second transition point).
(See general title on page 170)

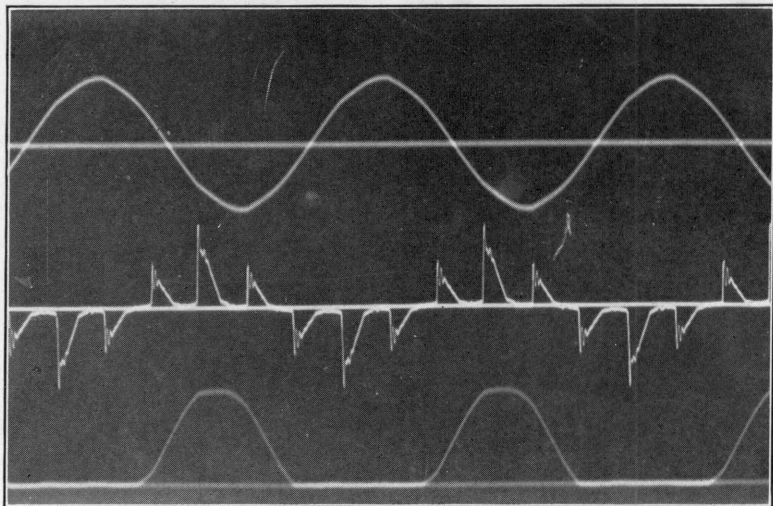

FIGURE 104.— $\frac{J}{J_K} = 0.60$, (in final straight line).
(See general title on page 170)

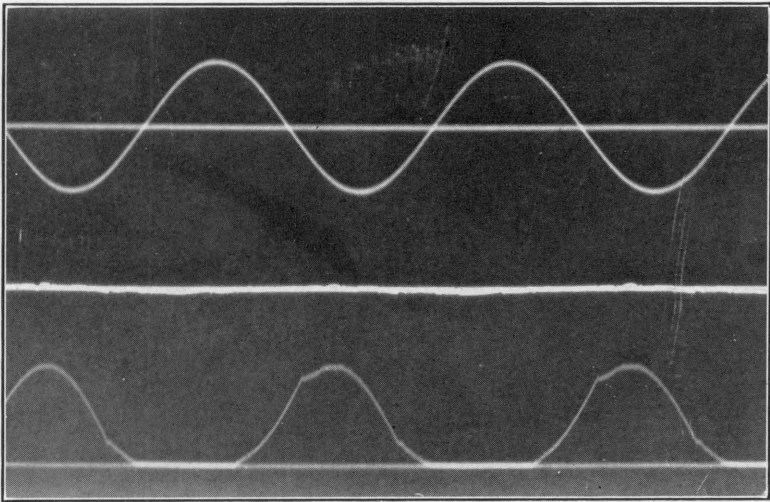

FIGURE 105.— $\frac{J}{J_K} = 0.68$, (short circuit).

(See general title on page 170)

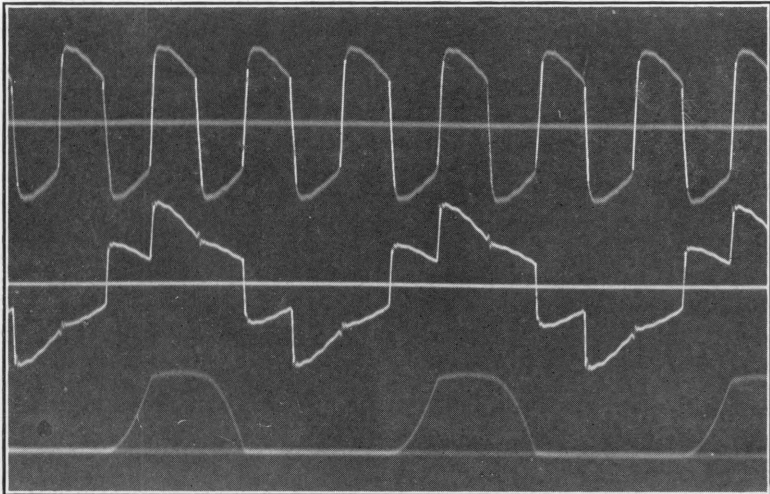

FIGURE 106.— $\frac{J}{J_K} = 0.29$, (first transition point).

FIGURES 106 to 110.—Wave shapes of an experimental double three-phase rectifier circuit with reactance in the supply lines. Primaries connected in delta. Calculated short-circuit output current, 172 amperes corresponding to $J_K = 258$ amperes. Nominal secondary voltage, 110 volts. In figures 106 and 107 the upper trace shows the interphase transformer voltage. In figures 108 to 110 the upper trace shows the line current. In all figures the central and lower traces show secondary voltage and current to the corresponding anode. For the higher currents a small direct voltage was applied in the output circuit to overcome arc-drop and resistance losses.

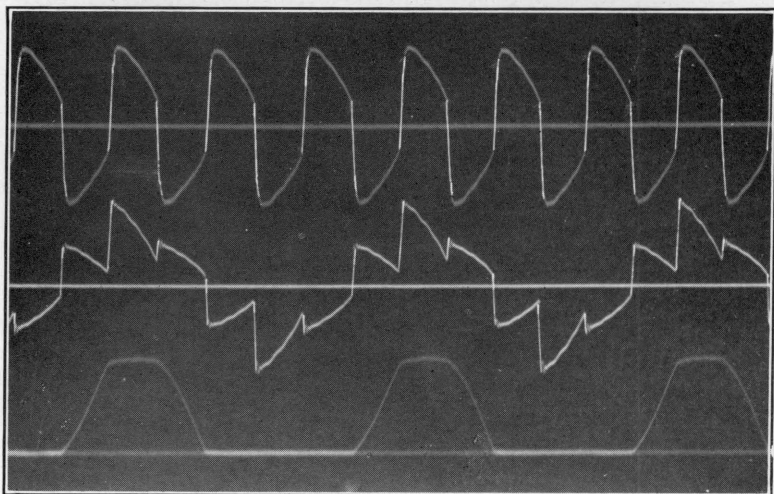

FIGURE 107.— $\frac{J}{J_K} = 0.44$. (in ellipse).
(See general title on page 173)

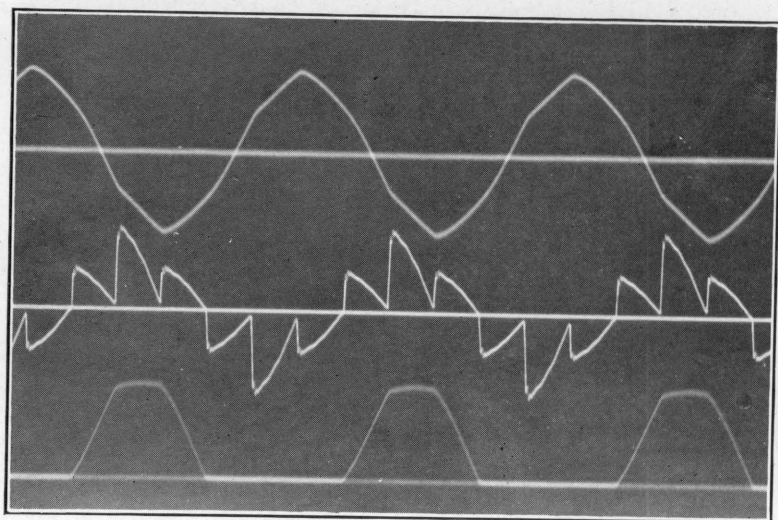

FIGURE 108.— $\frac{J}{J_K} = 0.51$, (second transition point).
(See general title on page 173)

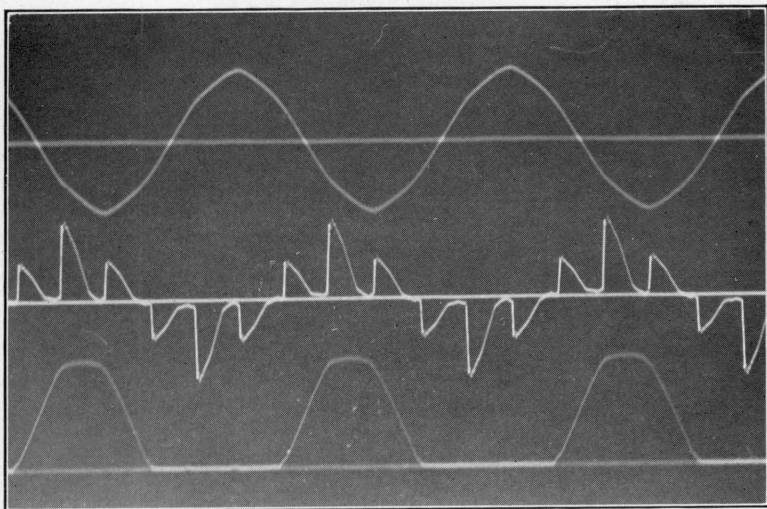

FIGURE 109.— $\frac{J}{J_K} = 0.59$. (in final straight line).
(See general title on page 173)

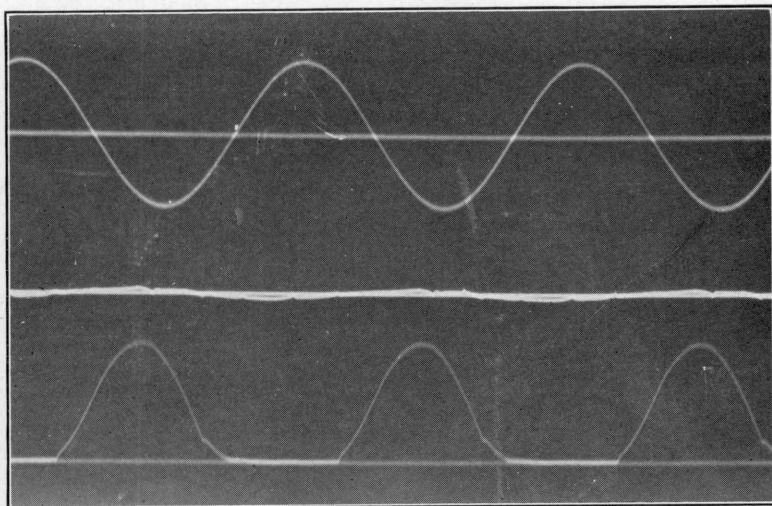

FIGURE 110.— $\frac{J}{J_K} = 0.67$, (short circuit).
(See general title on page 173)

CHAPTER XI

REGULATION OF SIX-PHASE RECTIFIERS WITH REACTANCE IN THE PRIMARIES OR SUPPLY LINES

In Chapter VIII the method by which the initial straight-line regulation of a six-phase rectifier can be calculated has already been demonstrated and the results of such calculations are shown in Table Vc. This straight-line regulation holds until the load is reached where an anode no longer commences to carry current at the instant its open-circuit voltage is equal to that of the preceding phase, or where the voltage of active phases is affected by commutation of others.

Though the regulation of six-phase rectifiers throughout the normal-load range may usually be calculated from such comparatively simple considerations, it is necessary in solving some problems to know the characteristics of the rectifier all the way to short-circuit. This chapter will, therefore, be devoted to consideration of several cases where the reactance is assumed to be lumped in the primary windings or supply lines.

Six-phase Rectifier with Line Reactance and Delta Connected Primaries.

Figure 111 shows a six-phase rectifier circuit with all the reactance located in the supply lines. Under light loads, when only one or two anodes carry current, the commutating currents take the paths indicated in figure 111a. This results in commutation of the same nature as with secondary reactance except that now the two phases not on the transformer legs with those being commutated lose their voltage completely while commutation is in progress, as shown in figure 112. Since these phases are not carrying current, this loss of voltage does not affect

the output until the period of commutation reaches 60 degrees.

Under this condition shown in figure 113, the phase about to enter the conducting group has zero voltage until the instant when it should enter the group. At this time commutation of the conducting phases is completed, and it acquires the potential required for its parallel operation with the phase immediately preceding it. Further increase in the period of commutation is impossible as long as the instantaneous output voltage is different from zero, for the phases being commutated would not allow the incoming phase to acquire its potential in time to join the conducting group, as in the double three-phase case.

As the period of commutation can no longer increase with an increase in load, the point at which the current starts to flow will occur later in the cycle, the delay increasing with the load. This results in the transition between the conditions shown in figures 113 and 114.

In figure 114, the delay in the starting of the current amounts to 30 degrees. Another change in the manner of operation must occur here, for the anodes carrying the load current touch zero voltage at a point where the idle phases also have no potential. A further delay in the starting of the current with no change in the period of current flow, other than its shift in phase, would result in the idle phases having a potential higher at times than those conducting the current.

Adjustment to increasing loads now occurs by a lengthening of the time during which each anode carries current, and this results in short-circuit conditions during portions of the cycle. Figure 115 indicates the wave shapes obtained and the periods during which each anode carries current. Short-circuit occurs when three anodes carry current simultaneously and is indicated by the absence of any secondary voltage.

This short-circuit is rather complicated in its nature but can be completely explained by two currents flowing across

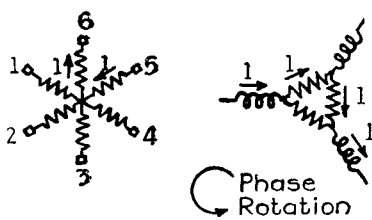

FIGURE 111a.

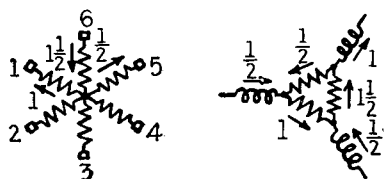

FIGURE 111b.

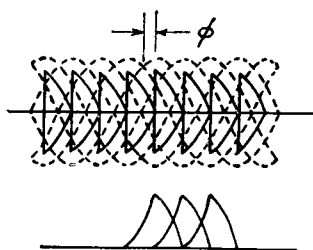

FIGURE 114.

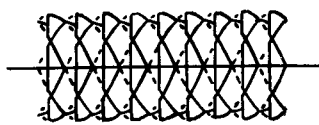

FIGURE 112.

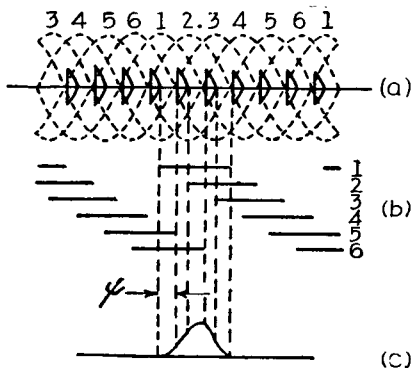

FIGURE 115.

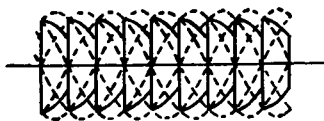

FIGURE 113.

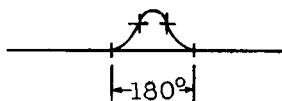
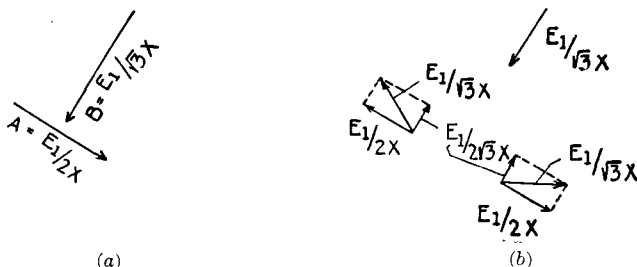

FIGURE 116.

FIGURES 111 to 116.—Six-phase circuit with delta-connected primaries and reactance in the supply lines, and resultant wave forms.

the primary network unrestrained by any counter electromotive force due to the load. The first of these is the normal commutating current shown in figure 111a. The second flows across the network at right angles to it, that is, it enters by passing through two lines in parallel, and leaves by the single remaining line, as shown in figure 111b. For simplicity, let the first current be denoted by A and the second by B . Being displaced 90 degrees in space phase from A , the current B will also lag A by 90 degrees in time phase as indicated in figure 117a. The voltage



FIGURES 117a and b.—Primary components of temporary short-circuit currents when the reactance is in the supply lines.

causing A to flow is the line voltage E_1 and the reactance is $2X$ where X is the reactance of each line. Hence, the value of A is $\frac{E_1}{2X}$. The current B is caused by the voltage between one line and the other two which is equal to the voltage between the first line and a point midway in potential between the second pair. This voltage is, therefore, $\frac{\sqrt{3}E_1}{2}$ and the reactance of the circuit is $\frac{3X}{2}$ giving B a value of $\frac{E_1}{\sqrt{3}X}$.

The voltage drops in the line reactances due to these two currents should completely absorb the applied voltages leaving nothing to be impressed across the transformer primaries. That this is true can be seen by inspection of figure 117b. The three vector diagrams are arranged in the same order as the reactances which they represent are

shown in figure 111. It will be seen that the total current through each reactance is $\frac{E_1}{\sqrt{3}X}$ and that the three are spaced 120 degrees apart in time phase.

The currents through the transformers must be so arranged that the sum of the secondary components is zero. This

TABLE IX

Phase	Open Circuit Voltage	A Current	B Current	Total
5	←	↖ $\frac{E_1^2}{2XE_2}$	↙ $\frac{E_1^2}{2\sqrt{3}XE_2}$	← $\frac{E_1^2}{\sqrt{3}XE_2}$
6	↘	↘ $\frac{E_1^2}{2XE_2}$	↗ $\sqrt{3}\frac{E_1^2}{2XE_2}$	↗ $\frac{E_1^2}{XE_2}$
1	↗		↘ $\frac{E_1^2}{\sqrt{3}XE_2}$	↘ $\frac{E_1^2}{\sqrt{3}XE_2}$

has already been done for the A components in solving the problem of the commutation of two phases and figure 111b shows the B components. The addition of the components of the currents shown in figure 111 is accomplished in Table IX. The relation of the currents to the open-circuit voltages of the three phases is also shown.

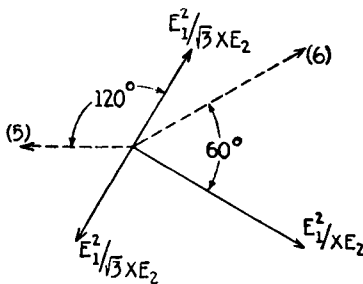

FIGURE 118.—Vectors representing successive currents in one phase.

As the output voltage of the rectifier approaches zero the temporary short-circuits last for longer periods of time, and at complete short-circuit of the rectifier the conditions in the windings are such that the currents just discussed will always be flowing in some of the windings.

Then, phase 1, after carrying the current indicated in Table IX for 60 degrees, would assume the conditions shown for phase 6 for the next 60 degrees, and then those of phase 5 for another 60-degree period. Figure 118 shows the three vectors representing successive conditions in phase 1. The conditions in phase 6 are repeated in phase 1 with a

lag of 60 degrees, and the conditions in phase 5 are repeated with a lag of 120 degrees. Figure 116 shows the anode-current wave shape obtained in this manner. It is interesting to notice that the central portion of the wave is part of a sine wave having an amplitude $\sqrt{3}$ times as large as the sine waves forming the other portions.

If there is a small output voltage the short-circuit of the alternating current is not continuous, but during each temporary short-circuit the currents will vary in the same manner as for zero output voltage.

Six-phase Rectifier with Reactance in Y-connected Primary.

The connections for a rectifier of this type are indicated in figure 119. A tertiary winding is included which is assumed to have no reactance. The secondary wave forms

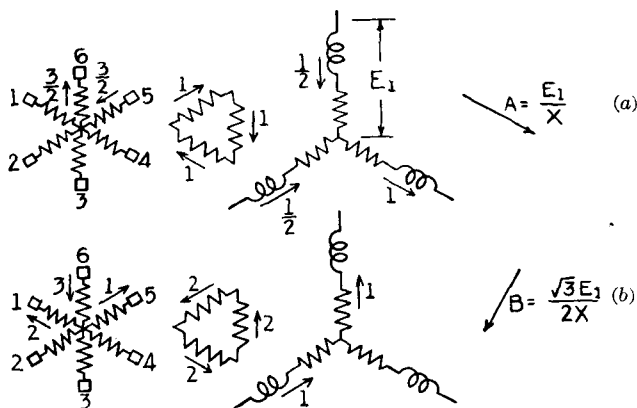

FIGURES 119a and b.—Six-phase rectifier circuit with reactance in Y-connected primary windings.

in this case will be the same as those obtained with the six-phase rectifier with line reactance just discussed. Under light loads, when one and two anodes carry the current, commutation of two anodes will result in each of them having a potential equal to the average of the open-circuit voltages. At the same time the other phases on the same transformer legs will have numerically equal negative poten-

tials, while the two remaining phases will be at zero potential.

After the period of commutation reaches 60 degrees, it will no longer be able to increase, but the anodes will carry current for 120-degree periods occurring later in the cycle as the load is increased.

The anodes carrying current will touch zero under the same conditions as before and thus result in temporary short-circuits. These short-circuits will give secondary currents similar to those previously obtained, but the manner in which they pass through the circuit is different. The paths taken by these currents are shown in figure 119, and the currents will be designated *A* and *B*, as before. Table X gives the vector diagrams of the secondary currents under the temporary short-circuit conditions.

TABLE X

Phase	Open Circuit Voltage	A Current	B Current	Total
5		$\frac{\sqrt{3}}{2} \frac{E_1^2}{X E_2}$	$\frac{\sqrt{3} E_1^2}{2 X E_2}$	$\frac{\sqrt{3} E_1^2}{X E_2}$
6		$\frac{\sqrt{3}}{2} \frac{E_1^2}{X E_2}$	$\frac{3\sqrt{3} E_1^2}{2 X E_2}$	$\frac{3 E_1^2}{X E_2}$
1		$\frac{\sqrt{3} E_1^2}{X E_2}$	$\frac{\sqrt{3} E_1^2}{X E_2}$	$\frac{\sqrt{3} E_1^2}{X E_2}$

Comparison of the numerical values of the currents is necessary to prove that both circuits discussed give exactly the same results. This will be done when the regulation curve for the two cases is calculated.

Calculation of Regulation Curve of Six-phase Rectifier with Reactance in Supply Lines.

The first portion of this regulation curve has been seen to be a straight line comparable with that of a rectifier having reactance in the anode leads. The root-mean-square value of the commutating current is $\frac{E_1^2}{2X_L E_2}$ and the root-mean-square value of the secondary currents on complete

short-circuit is $\frac{E_1^2}{6X_L E_2}$. Hence, the apparent reactance per secondary winding is $\frac{X_L E_2^2}{E_1^2}$ for commutation, and $\frac{6X_L E_2^2}{E_1^2}$ for alternating-current short-circuit. Since the current coordinates are in terms of J_K derived from the latter value and the regulation is calculated from the former, the voltage

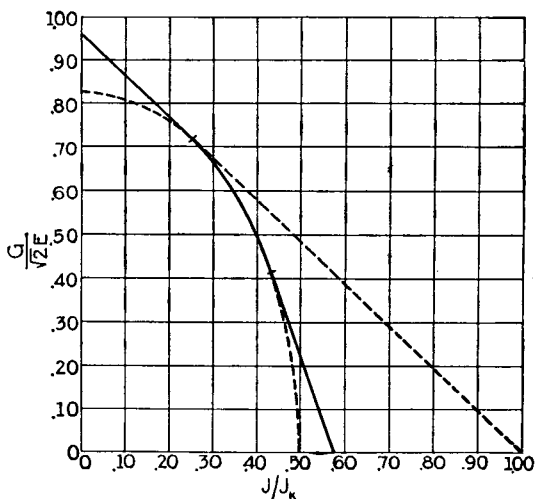

FIGURE 120.—Regulation curve of six-phase rectifier circuits with reactance in the supply lines (delta-connected primaries) or in star-connected primary windings.

will fall only one-sixth as rapidly as in the case of secondary reactance. From Table VII it is seen, therefore, that the voltage at no load will be $\frac{3\sqrt{2}E}{\pi}$, or $0.955\sqrt{2}E$, and that if the line is extended it will cut the current axis at J_K , as shown in figure 120.

Throughout the second section of the regulation curve, the starting of an anode is delayed because of the commutation of preceding anodes. Let ϕ be the angle of delay which will increase with the load. At the start of the section, as shown in figure 113, ϕ will be zero and it will increase to

30 degrees at the end of the section, as indicated in figure 114. The output voltage will, therefore, be given by

$$\begin{aligned}
 \frac{G}{\sqrt{2E}} &= \frac{\sqrt{3}}{2} \cdot \frac{3}{\pi} \int_{\phi}^{60^{\circ} + \phi} \cos \theta d\theta, \\
 &= \frac{3\sqrt{3}}{2\pi} \left\{ \sin (60^{\circ} + \phi) - \sin \phi \right\}, \\
 &= \frac{3\sqrt{3}}{2\pi} \left\{ \frac{1}{2} \sin \phi + \frac{\sqrt{3}}{2} \cos \phi - \sin \phi \right\}, \\
 &= \frac{3\sqrt{3}}{2\pi} \left\{ \frac{\sqrt{3}}{2} \cos \phi - \frac{1}{2} \sin \phi \right\}, \\
 &= \frac{3\sqrt{3}}{2\pi} \sin (60^{\circ} - \phi). \tag{42}
 \end{aligned}$$

It will be seen from the current wave forms that the maximum value of the current to an anode is equal to the output current, and that all that is necessary to calculate the output current is to determine the increase in current due to the commutating voltage during a period of 60 degrees. In figure 113 the commutating voltage starts with zero value, but in figure 114, the starting has been delayed 30 degrees, and the commutating voltage is therefore 30 degrees further advanced at the time commutation begins. The output current obtained in this manner is

$$\begin{aligned}
 J &= \frac{\sqrt{2} E_1^2}{2X_L E_2} \left\{ \cos \phi - \cos (\phi + 60^{\circ}) \right\}, \\
 &= \frac{\sqrt{2} E_1^2}{2X_L E_2} \left\{ \cos \phi - \frac{1}{2} \cos \phi + \frac{\sqrt{3}}{2} \sin \phi \right\}, \\
 &= \frac{\sqrt{2} E_1^2}{2X_L E_2} \left\{ \frac{1}{2} \cos \phi + \frac{\sqrt{3}}{2} \sin \phi \right\}, \\
 &= \frac{E_1^2}{\sqrt{2} X_L E_2} \cos (60^{\circ} - \phi). \tag{43}
 \end{aligned}$$

Comparison of equations (42) and (43) immediately indicates the elliptical nature of the second section of the curve. The nominal short-circuit output current is $6\sqrt{2}$ times the

root-mean-square alternating short-circuit current per secondary on complete short-circuit and is $\frac{\sqrt{2}E_1^2}{X_L E_2}$.

Therefore,

$$\frac{J}{J_K} = \frac{1}{2} \cos (60^\circ - \phi). \quad (44)$$

In the third and final section of the curve there is no time at which the entire load current is carried by one anode. In order to determine the output it is, therefore, necessary either to integrate the anode current over a cycle or take the sum of the anode currents at any instant. Following the latter course, assume that one of the anodes has been carrying current for a time equal to the period of short-circuit ψ . Only one other anode will be active at this time, and it will have carried current through the angle $(60^\circ + \psi)$, as can be seen by inspection of figure 115.

The current to the first anode will be the increment due to the short-circuit current. The magnitude and phase of this current can be obtained from Table IX, and it is seen that the first anode is carrying a current equal to

$$\frac{\sqrt{2}E_1^2}{\sqrt{3}X_L E_2}(1 - \cos \psi).$$

The current to the second anode is equal to the current to the first plus the increment obtained during the 60-degree interval separating the two. In passing through this 60-degree interval there is first a period when only two anodes carry current, and this is followed by another period of temporary short-circuit. While only two anodes carry current, the current change is due to the voltage between phases and the increment due to this is

$$\frac{E_1^2}{\sqrt{2}X_L E_2} \sin (60^\circ - \psi).$$

During the short-circuit period which follows, the increment is

$$\frac{\sqrt{2}E_1^2}{X_L E_2} \{ \sin (60^\circ + \psi) - \sin 60^\circ \}.$$

The magnitude and phase of the current producing this change can be obtained from Table IX.

The output current is the sum of the two anode currents or

$$J = \frac{2\sqrt{2}E_1^2}{\sqrt{3}X_L E_2}(1 - \cos \psi) + \frac{E_1^2}{\sqrt{2}X_L E_2} \sin (60^\circ - \psi) \\ + \frac{\sqrt{2}E_1^2}{X_L E_2} \left\{ \sin (60^\circ + \psi) - \frac{\sqrt{3}}{2} \right\},$$

which when reduced to simpler form becomes

$$J = \frac{1}{\sqrt{2}\sqrt{3}} \frac{E_1^2}{X_L E_2} \{1 + \sin (30^\circ + \psi)\}, \quad (45)$$

or in terms of J_K

$$\frac{J}{J_K} = \frac{1}{2\sqrt{3}} \{1 + \sin (30^\circ + \psi)\}. \quad (46)$$

The voltage during the final section consists of the average of small portions of sine waves which have an amplitude $\frac{\sqrt{3}}{2}$ times that of the secondary open-circuit voltages. The output voltage is therefore given by

$$\frac{G}{\sqrt{2}E} = \frac{\sqrt{3}}{2} \cdot \frac{3}{\pi} \int_0^{60^\circ - \psi} \sin \theta d\theta, \\ = \frac{3\sqrt{3}}{2\pi} \{1 - \cos (60^\circ - \psi)\}, \\ = \frac{3\sqrt{3}}{2\pi} \{1 - \sin (30^\circ + \psi)\}. \quad (47)$$

Since both voltage and current are linear functions of $\sin (30^\circ + \psi)$, a straight-line relation between G and J throughout the final section of the curve is obtained.

Regulation Curve with Reactance in Y-connected Primary.

It has already been shown that the wave shapes obtained with reactance in a Y-connected primary, as in figure 119, are the same as those obtained with reactance in the supply

lines. It now remains to compare the magnitude of the commutating and short-circuit currents and show that they are in the same ratio in both cases. This is done in Table XI and the identity of the two regulation curves is thereby established.

TABLE XI
COMPARISON OF CURRENT COMPONENTS, SIX-PHASE RECTIFIERS

	Reactance in supply lines (pri- mary delta connected)	Reactance in star- connected primaries	
Commutating current for two otherwise unconnected phases (root-mean-square).	$\frac{E_1^2}{2X_L E_2}$	$\frac{3E_1^{2*}}{2X_1 E_2}$	
Alternating components of temporary short-circuit current (root-mean-square).	$\left\{ \begin{array}{l} \text{Leading} \\ \text{and trail-} \\ \text{ing anodes.} \\ \text{Central} \\ \text{anode} \end{array} \right.$	$\frac{E_1^2}{\sqrt{3}X_L E_2}$	$\frac{\sqrt{3}E_1^2}{X_1 E_2}$
		$\frac{E_1^2}{X_L E_2}$	$\frac{3E_1^2}{X_1 E_2}$
Alternating short-circuit current (root-mean-square) per phase for all six phases short-circuited.	$\frac{E_1^2}{6X_L E_2}$	$\frac{E_1^2}{2X_1 E_2}$	

* E_1 is taken as the voltage to neutral when the primaries are connected in Y.

Experimental Verification of Results.

Figure 121 shows an experimental regulation curve obtained with a rectifier circuit having reactance coils in the supply lines. Agreement with the calculated curve is quite satisfactory. The small difference is probably due to the arc-drop which can distort the wave shapes at the low output voltages obtained. Figure 122 is an oscillogram showing line current, secondary voltage, and anode current. The conditions shown correspond to a load slightly less than that at which the regulation curve starts to follow an ellipse. The wave shapes obtained, therefore, lie between those of figures 112 and 113. Figure 123 is an oscillogram obtained well along on the ellipse and corresponding closely to figure 114. It will be noticed that the resistance losses or arc-drop have become of sufficient relative magnitude to give a measurable secondary voltage

during the period when the theory based on reactance alone says it should be zero. The general character of the wave shapes is not seriously affected, however.

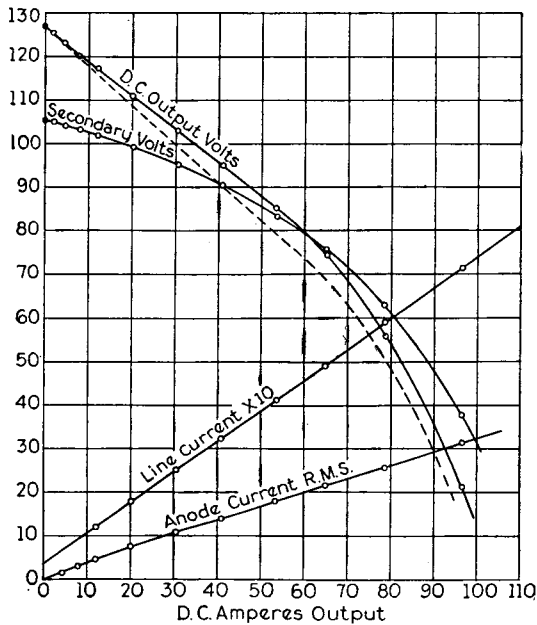

FIGURE 121.—Experimental regulation curve of a six-phase rectifier circuit with reactances in the supply lines (Delta-connected primaries). Calculated short-circuit output current, neglecting arc-drop and resistance losses, 120.4 amperes. Dotted line shows calculated output voltage. Nominal secondary voltage, 110.

Six-phase Rectifier with Reactance in Delta-connected Primary.

A six-phase rectifier with reactance in delta connected primaries has characteristics different from the other six-phase cases discussed. A circuit of this type is shown in figure 124. Operation occurs first on one or two and then on two or three anodes in much the same manner as though the reactance were located in the anode leads. The voltage of the idle phases is disturbed, however, being held equal and opposite to that of the group of phases carrying current, and this makes it impossible for a fourth phase to

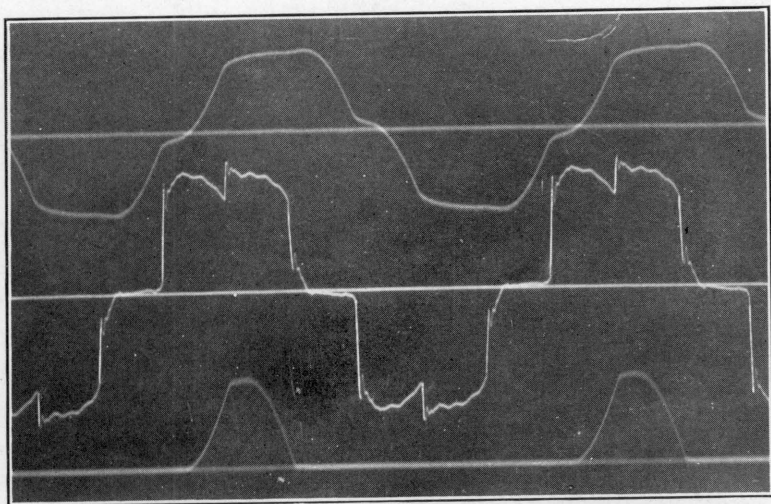

FIGURE 122.—Oscillogram corresponding to load of 30.5 amperes (figure 121). Upper trace shows line current, center trace shows voltage across one transformer secondary, and lower trace shows corresponding anode current.

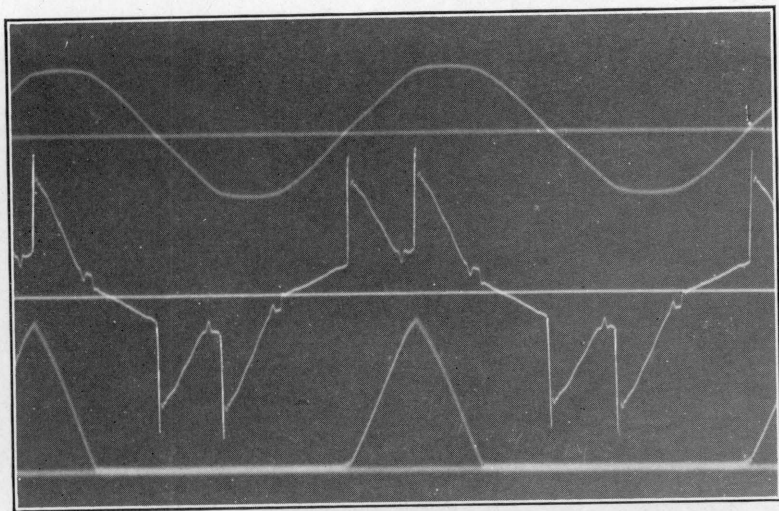

FIGURE 123.—Oscillogram corresponding to load of 96.5 amperes (figure 121). Upper trace shows line current, center trace shows voltage across one transformer secondary, and lower trace shows corresponding anode current.

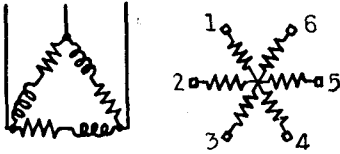

FIGURE 124.

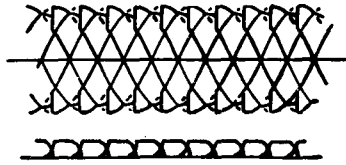

FIGURE 125.

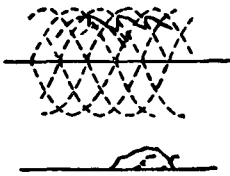

FIGURE 126.

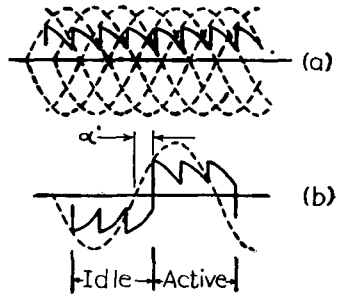

FIGURE 127.

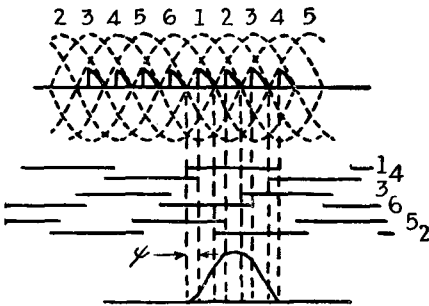

FIGURE 129.

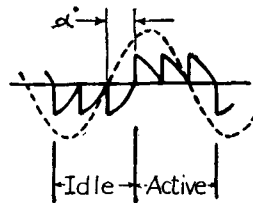

FIGURE 128.

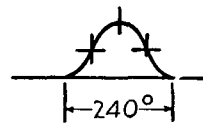

FIGURE 130.

FIGURES 124 to 130.—Six-phase circuit with reactance in delta-connected primary windings and resultant wave forms.

enter the conducting group under the same conditions as the third. Figure 125 shows operation with one or two phases carrying current simultaneously, and figure 126 shows two or three phases carrying the current. Increasing the load beyond the value resulting in the wave shapes of figure 126 causes a gradual lengthening of the time during which an anode carries current until each anode is carrying current for a period of 180 degrees. Under this condition the current will always be carried by three anodes, and at 60-degree intervals one anode will drop out of the conducting group and its mate, on the same transformer leg, will immediately enter it. Figure 127*a* shows the output voltage wave and figure 127*b* shows the voltage of one transformer secondary.

For heavier loads the period of conductivity of the anodes does not change but suffers a lag in phase until the instant of starting has been delayed by an angle of roughly 15 degrees. The voltage of the active phases then touches zero at several points, as shown in figure 128, and heavier loads are carried with temporary short-circuits and a longer period of conductivity for each anode, as shown in figure 129.

The temporary short-circuits are fairly simple in their nature. Just before phase 1 enters the conducting group (figure 129) the current is carried by phases 4, 5, and 6. While these three secondaries are on the three legs of the transformer, phase 5 has the wrong polarity to give three short-circuit currents 120 degrees apart. When, however, phase 1 enters the conducting group, it is possible for phases 4, 5, and 6 to carry the unrestrained alternating short-circuit currents of the three phases. The sum of these three currents will be twice that of phase 5. This current cannot pass through the rectifier because of the choke, but an equal and opposite current can flow through phases 1 and 4 in parallel, making the total variation of all the anode currents equal to zero. Thus, there is no restraint on the current carried by secondary windings on three of the legs and yet the total current change is zero.

Figure 130 shows the anode-current wave form derived from the temporary short-circuit currents when the output voltage is zero.

Calculation of Regulation Curve of Six-phase Rectifier with Reactance in Primary Windings.

The reactance presented to the commutating currents throughout the first and second portions of the regulation curve is only half the value limiting the current flow on

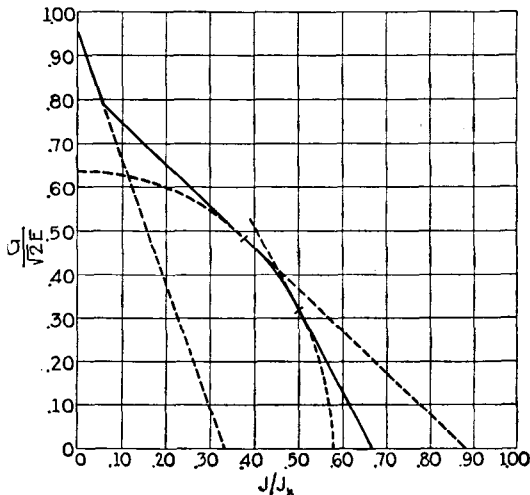

FIGURE 131.—Regulation curve of a six-phase rectifier circuit with reactance in delta-connected primary windings.

complete short-circuit of the transformer. The two straight lines comprising these sections will, therefore, drop only half as rapidly as in the case of secondary reactance when the outputs are expressed in terms of the nominal short-circuit current J_K .

The third section of the regulation curve consists of an ellipse, as shown in figure 131. In this case it is convenient to calculate the output current by the use of equation (34) derived for use when the reactance is in the anode leads. The equivalent value of the primary reactance is $X_1 \left(\frac{E_2}{E_1} \right)^2$ and the angle α which is determined under con-

ditions where no coupling between windings is present to affect the starting can be replaced by the angle α' , as shown in figure 127. This results in

$$\begin{aligned} JX_1 \left(\frac{E_2}{E_1} \right)^2 &= 2 \cdot 2 \cdot \sqrt{2} E_2 \sin \left(\alpha' + \frac{\pi}{6} \right) \sin \frac{\pi}{6} \\ &\quad + 1 \cdot 2 \cdot \sqrt{2} E_2 \sin \left(\alpha' + \frac{\pi}{2} \right) \sin \frac{\pi}{6} - \frac{2\pi \cdot 3 \cdot 2}{6 \cdot 2} G, \\ &= 2\sqrt{2} E_2 \cos \alpha' + \sqrt{2} \sqrt{3} E_2 \sin \alpha' - \pi G. \end{aligned} \quad (48)$$

The output voltage is given by

$$\begin{aligned} \frac{G}{\sqrt{2} E_2} &= \frac{3}{\pi} \int_{\alpha'}^{\alpha' + 60^\circ} \frac{2}{3} \sin (\theta + 60^\circ) d\theta, \\ &= \frac{2}{\pi} \left[-\cos (\theta + 60^\circ) \right]_{\alpha'}^{\alpha' + 60^\circ}, \\ &= \frac{2}{\pi} \{ \cos (\alpha' + 60^\circ) - \cos (\alpha' + 120^\circ) \}, \\ &= \frac{2 \cos \alpha'}{\pi}. \end{aligned} \quad (49)$$

And by substituting the value of G thus obtained in equation (48)

$$\begin{aligned} JX_1 \left(\frac{E_2}{E_1} \right)^2 &= 2\sqrt{2} E_2 \cos \alpha' + \sqrt{2} \sqrt{3} E_2 \sin \alpha' \\ &\quad - 2\sqrt{2} E_2 \cos \alpha' = \sqrt{2} \sqrt{3} E_2 \sin \alpha'. \end{aligned} \quad (50)$$

Comparison of equation (50) with equation (49) shows immediately the elliptical nature of this section of the regulation curve.

The final portion of the regulation curve may also be calculated by the method used in the case of reactance in the anode leads. Allowance must be made, however, for the fact that during the first temporary short-circuit through which an anode passes while carrying current, it does not carry its own current but that of a preceding anode reversed, and that during the last temporary short-circuit it carries this current in addition to its own. Taking the anode current at the end of the first temporary short-

circuit and at points 60 and 120 degrees further along and remembering that there will be no average direct voltage during the first short-circuit period, there results

$$\begin{aligned}
 J &= 3\sqrt{2}\frac{E_1^2}{X_1E_2} (1 - \cos \psi) \\
 &+ 2\sqrt{2}\frac{E_1^2}{X_1E_2} \{\sin (30^\circ + \psi) - \sin (-30^\circ + \psi)\} \\
 &+ \sqrt{2}\frac{E_1^2}{X_1E_2} \{\sin (90^\circ + \psi) - \sin (30^\circ + \psi)\} \\
 &- \frac{\pi G}{X_1} \left(\frac{E_1}{E_2}\right)^2 \\
 &= \frac{\sqrt{2}E_1^2}{X_1E_2} \left\{ 3 - \frac{1}{2} \cos \psi - \frac{\sqrt{3}}{2} \sin \psi \right\} - \frac{\pi GE_1^2}{X_1E_2^2}, \\
 &= \frac{\sqrt{2}E_1^2}{X_1E_2} \{3 - \sin (30^\circ + \psi)\} - \frac{\pi GE_1^2}{X_1E_2^2}.
 \end{aligned}$$

The nominal short-circuit output current J_K is $\frac{3\sqrt{2}E_1^2}{X_1E_2}$;

hence,

$$\frac{J}{J_K} = 1 - \frac{\sin (30^\circ + \psi)}{3} - \frac{\pi G}{3\sqrt{2}E_2}. \quad (51)$$

The output voltage is given by

$$\begin{aligned}
 \frac{G}{\sqrt{2}E_2} &= \frac{2}{3} \cdot \frac{3}{\pi} \int_0^{60^\circ - \psi} \sin \theta d\theta, \\
 &= \frac{2}{\pi} [-\cos \theta]_0^{60^\circ - \psi}, \\
 &= \frac{2}{\pi} \{1 - \sin (30^\circ + \psi)\}. \quad (52)
 \end{aligned}$$

A relation between J and G free from ψ is obtained by solving equation (52) for $\sin (30^\circ + \psi)$ in terms of G and substituting the value obtained in equation (51). Thus,

$$\sin (30^\circ + \psi) = 1 - \frac{\pi G}{2\sqrt{2}E_2}$$

and

$$\frac{J}{J_K} = \frac{2}{3} - \frac{\pi G}{6\sqrt{2}E_2}, \quad (53)$$

or

$$\frac{G}{\sqrt{2}E_2} = \frac{6}{\pi} \left(\frac{2}{3} - \frac{J}{J_K} \right). \quad (54)$$

Experimental Regulation Curve with Primary Reactance.

Figure 132 shows an experimental regulation curve for a small six-phase rectifier with reactance in the primary

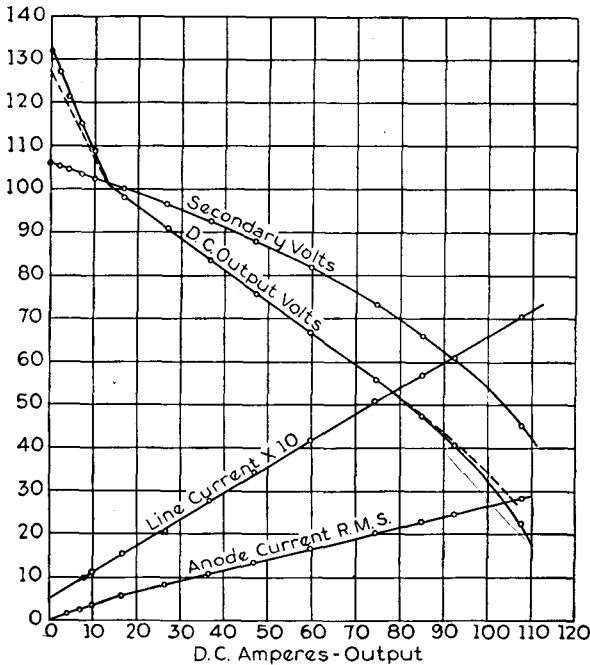

FIGURE 132.—Experimental regulation curve of a six-phase rectifier circuit with reactance in delta-connected primary windings. Calculated short-circuit output current, neglecting arc-drop and resistance losses, 143.3 amperes. Dotted line shows calculated output voltage. Nominal secondary voltage, 110.

windings. The agreement with the calculated curve is very good. Figures 133, 134, and 135 show oscillograms corresponding to output currents of 7, 47, and 108 amperes, respectively. The upper trace shows the line current, the

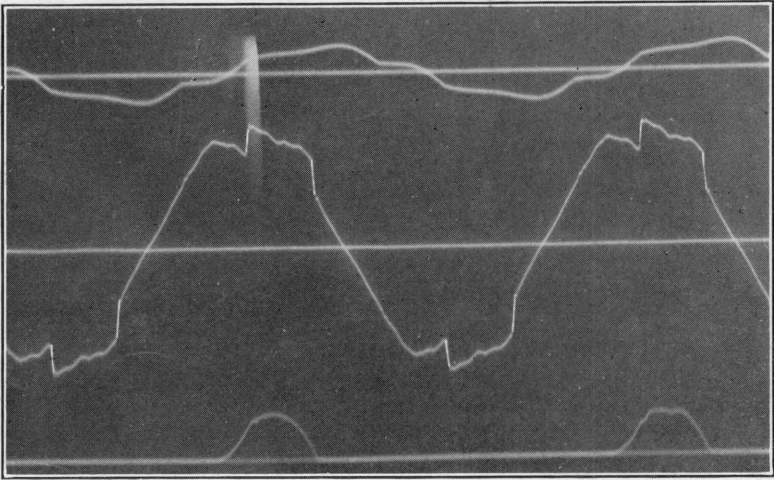

FIGURE 133.—Oscillogram corresponding to load of 7 amperes (figure 132). Upper trace shows line current, center trace shows voltage across one transformer secondary, and lower trace shows corresponding anode current.

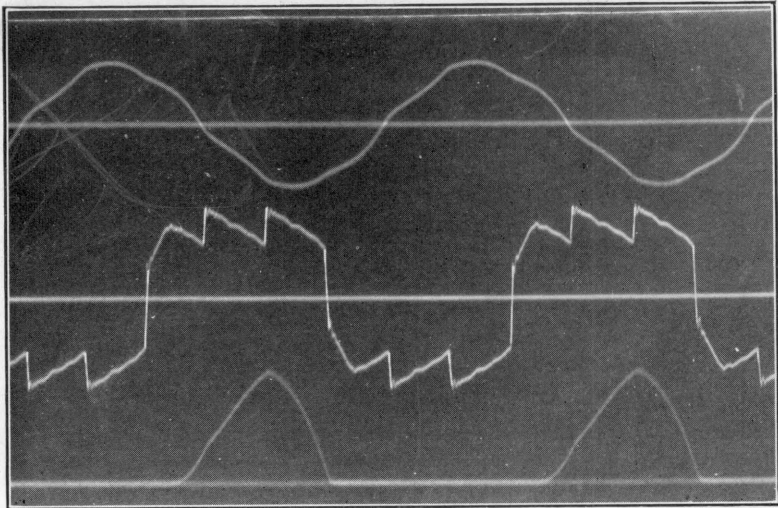

FIGURE 134.—Oscillogram corresponding to load of 47 amperes (figure 132). Upper trace shows line current, center trace shows voltage across one transformer secondary, and lower trace shows corresponding anode current.

next shows the voltage of a secondary winding, and the lower trace shows the corresponding anode current. Comparison of these wave shapes with the theoretical ones shows very close agreement.

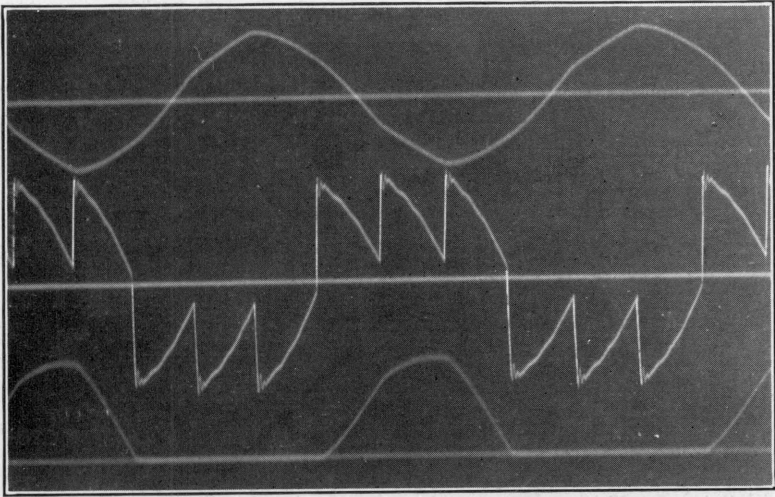

FIGURE 135.—Oscillogram corresponding to load of 108 amperes (figure 132). Upper trace shows line current, center trace shows voltage across one transformer secondary, and lower trace shows corresponding anode current.

CHAPTER XII

SPECIAL REGULATION PROBLEMS AND COMPOUNDING OF RECTIFIERS

As with other electrical apparatus, the regulation of mercury arc rectifiers assumes great importance when parallel operation is required. Furthermore, there will be two distinct types of parallel operation, for the rectifier proper may operate in parallel with another, or a complete rectifier including the transformer may be required to operate in parallel with other apparatus.

Negative Resistance Characteristic of Mercury Arc.

In the first part of this book it is shown¹ that the arc-drop in the rectifier proper decreases with an increase in current over a considerable part of the working range. This is mathematically equivalent to a negative resistance and makes it impossible for two rectifiers to operate in parallel without additional apparatus.

The most obvious means of obtaining stability is to insert a small resistance in series with each anode so that the total voltage drop will increase as the current increases. This is very satisfactory when making measurements in the laboratory, but in commercial applications is undesirable because of the losses involved.

Current-dividing Compensators.

Since the anode currents are of a pulsating nature, it is possible to use reactances to force the proper current division. Where two anodes are to operate in parallel, these reactances may be combined, as shown in figure 136, so that current enters at the center of a winding and flows to anodes connected at either end. In this case no appreciable voltage

¹ Chapter V, figure 23.

is induced in the windings unless a change occurs in one anode current without an equal change in the other. Under normal operating conditions the voltage drop is only the slight amount due to the leakage reactance of the windings but, when an unbalance occurs, the full exciting reactance of the compensator is available to force proper current division. As the direct component of the current is flowing in opposite directions in the two halves of the winding, no saturation of the iron will occur and this means a substantial saving in the material required to build the compensators. A further economy can also be attained by building them in polyphase groups.

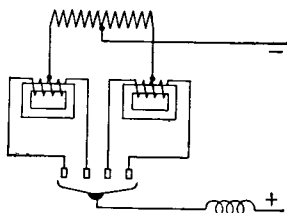

FIGURE 136.—Current-dividing compensators.

Parallel Operation of Complete Rectifiers.

Due to the loss in voltage which occurs during the period of commutation, the output voltage of complete rectifier units—consisting of rectifier and transformer—will always be found to decrease with increase of load unless special means are taken to prevent it. For this reason complete units are inherently stable when connected in parallel, and the problem is to arrange the slope of the regulation curve of each rectifier so that it will always take its proper share of the total load.

It has already been seen¹ how the slope of the first section of the regulation curve can be calculated if the reactance presented to the commutating currents is known. This quantity can be determined by measurement of the short-circuit current obtained by connecting two adjacent secondaries, or by calculation from the dimensions of the transformer and paths of the short-circuit currents. The latter method, however, involves a considerable knowledge of transformer design, and is beyond the scope of this book.

¹ Chapter VIII.

One point still remains to be considered. This is the determination of the load at which the end of the first section of the regulation curve is reached, for it will usually be desirable to have this correspond to a load somewhat above the rated output.

Maximum Loads Which Can Be Carried with Straight-line Regulation Curves.

The straight-line regulation curve is obtained when a phase always starts to carry current at the same point in the cycle and each phase has an effective reactance which may be considered as though lumped in the anode leads. If more than two phases carry current simultaneously and the reactance is distributed throughout the transformer, the second requirement usually will not be fulfilled because of the coupling between phases.

At very light loads current will start to flow to an anode when its open-circuit voltage is equal to that of the preceding phase, and the phase angle will be the same as that determined for the case of secondary reactance in Chapter IX. With distributed reactance the end of the first straight line portion of the regulation curve will usually be reached when the voltages of the idle anodes are so affected by coupling with other phases that they no longer enter the conducting group at this time. If preliminary arcs are prevented from starting, as shown in figure 113, however, the output voltage will be unaffected. This might be expected, for it was shown in the case of secondary reactance that these arcs represented a transition between straight lines and had no effect on output until the period of the preliminary arc extended so as to leave no gap between itself and the main arc.

In the three cases considered in Chapter X, double three-phase rectifiers with reactance in primaries connected in Y or Δ , or reactance in the supply lines, the conditions for straight-line regulation are fulfilled until the period of commutation reaches 60 degrees. For heavier loads, the voltage of the phases which are idle is so affected that they

no longer commence to carry current at the same point in the cycle. At the transition point, the output voltage is $0.75G_0$, where G_0 is the no-load value, as can be readily calculated after inspection of figure 90. If part of the reactance were in the secondary leads, the voltage of the phases while inactive would not be distorted so much, but the period of the distortion would be the same, and the case of distributed reactance, therefore, has the same limit as the cases of primary or line reactance. If all the reactance were in the secondary leads, the straight line would extend to lower voltages, as shown in figure 84, but this case is not likely to be met in practice.

With a six-phase rectifier with reactance in Δ -connected primaries or in the secondary windings the first straight line extends only as far as is shown in figure 84. By solving the equations of Table VII for the two cases where $n = 2$ and $n = 3$, it is found that they intersect when $\frac{G}{\sqrt{2E}} = 0.786$, and as G_0 is 0.955, the ratio of the output voltage at the end of the first straight line to that at no load is 0.823. If it can be assumed that all the reactance is in the supply lines in the case of delta-connected primaries, or that it is in Y-connected primary windings of a transformer with a reactanceless tertiary winding, it will be found that the ratio of the output voltages at the two ends of the straight-line regulation curve is 0.75, but these conditions are not likely to be realized in practice. The ratio 0.823 is a conservative figure to apply to the usual case in which the reactance is distributed, even though it is possible for reactance in series with the supply lines to interfere with the transition from the conditions when $n = 2$ to those when $n = 3$.

Voltage Control by Anode Reactors.

In cases where it is desired to have a drooping output-voltage characteristic, it is convenient to add reactance in the anode leads. This not only increases the rate at which the voltage decreases with load, but may also be used to

obtain stable division of current when several rectifiers are operating in parallel from the same transformers. It has already been seen how the reactors for two anodes which are to operate in parallel may be combined on one core and thus avoid both saturation of the iron and reactive drops. It is now desired, however, to obtain a voltage across the reactors for use in producing regulation.

This may be accomplished by a scheme such as shown in figure 137, illustrating a double three-phase transformer bank supplying two rectifiers in parallel. Saturation of the cores is avoided by having two windings wound in

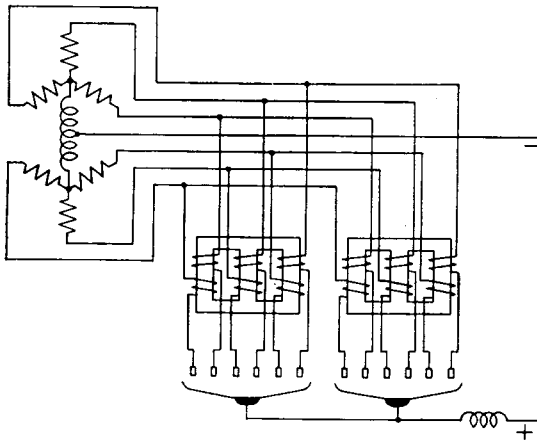

FIGURE 137.—Use of anode reactors in a double three-phase circuit.

opposite directions on each leg, but the currents through these windings are 180 degrees out of phase instead of being in phase as before. Considerable reactance is therefore presented to them. Under normal loads only one anode on a leg is active at any time and, hence, the effect of one anode on the other consists of a disturbance of its voltage while it is not conducting current. This can have no effect on the output characteristics. Under short-circuit conditions, however, the anodes carry current for longer periods of time, and the mutual reactance of the windings becomes an additional factor in limiting the current.

Voltage Control by Tap Changers or Potential Regulators.

Since mercury arc rectifiers have an inherently constant ratio of direct to alternating voltage which varies only because of the drops in the resistances and reactances of the circuit, it is necessary to use additional apparatus if an output voltage which increases with load is desired. This is often accomplished by means of potential regulators which vary the alternating voltage, or tap changers which vary the transformer ratio. Such devices can be controlled by voltage regulators and thus made automatic in their action, but the resulting complication is not entirely desirable from the standpoint of either reliability or cost.

Possibility of Compound Rectifiers.

While each rectifier circuit has a fixed voltage ratio, this ratio is not the same for different types of circuits. If, then, the scheme of connections can be changed gradually due to some action of the load current as it increases, from a circuit giving a low voltage ratio to one giving a high ratio, compound operation is attained. Taking a specific case, let it be assumed that some means are available for gradually passing from a double three-phase connection to a six-phase connection as the load is increased. The output voltage would then be that of a three-phase rectifier at no load and approach that of a six-phase rectifier when fully loaded. The difference in the two is sufficient to overcome the losses due to resistance and reactance and give a flat regulation curve or even one in which the voltage increases slightly with load.

Smooth transition between the two connections requires a gradual elimination of the action of the interphase transformer. This can be accomplished by eliminating its effect for part of the cycle and making this inactive period increase in length as the load is applied. Consideration of the wave forms of the voltage applied to the interphase transformer and the resultant currents indicates how this can be achieved.

Figure 138 shows the output voltage waves of the rectifier when operating with either the double three-phase or six-phase connection and neglecting resistance and reactance losses. The voltages of the two three-phase groups when separated are represented by e_1 and e_2 which are averaged to e_a by the interphase transformer, and e_6 shows the output voltage with six-phase operation. The voltage across the interphase transformer is the difference between e_1 and e_2 and is shown as e_d . This voltage causes a current to flow through the interphase transformer, its exciting current, which is shown as i_d . In order that this current

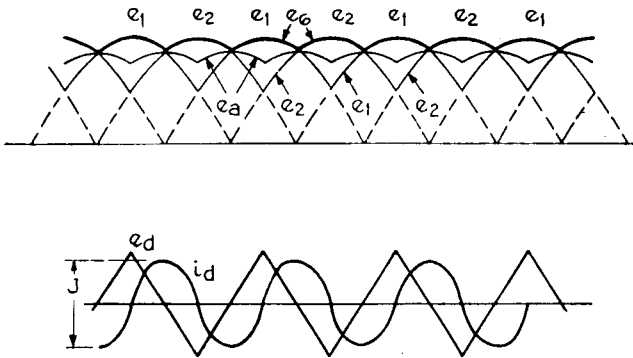

FIGURE 138.

may flow, however, the output current of each half of the rectifier must be as large as or larger than the amplitude of the exciting current, for otherwise the total current from one three-phase group would have a tendency to reverse in sign. With load currents greater than the total swing (positive to negative) of the exciting current, then, operation will be as a double three-phase rectifier, but if the amplitude of the exciting current increases to the point where it can draw the total current of half of the interphase transformer down to zero, no further current change can take place to induce voltage in the interphase transformer. Operation as a double three-phase rectifier then takes place for only part of the cycle and is supplemented by operation as a

six-phase rectifier during those portions of the cycle for which the interphase transformer is out of action.

Figure 139 shows the wave shapes under this condition. A value of exciting current has been used which has an amplitude equal to the entire rectified current J . With this value, the load current is divided between the two three-phase rectifiers half the time and carried by one for half the time. While both rectifiers are carrying current, the output current is being transferred from one group to the other due to the exciting current i_a caused by the difference in voltage between the groups. When this transfer is

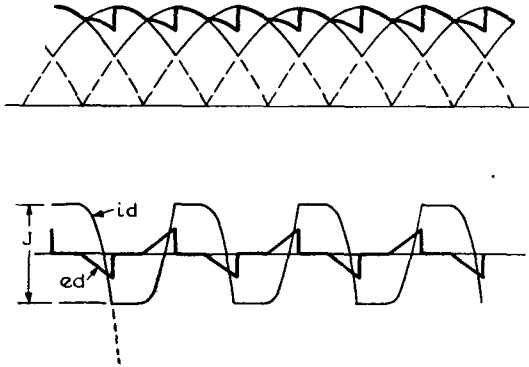

FIGURE 139.

completed, the exciting current can no longer flow and the potential of both groups assumes the value corresponding to the one carrying the current.

Saturation of the core of the interphase transformer is a ready means of altering its exciting current as desired. Figure 140 is a diagrammatic representation of a saturation regulator adapted for this use. It consists of a four-legged core on which two sets of windings are placed. One winding consists of two circuits surrounding the two central legs individually and so connected that the upper and lower halves of each will function as the two halves of the interphase transformer circuit L_1 and L_2 , respectively. The flux produced by the exciting current circulates in

these two central legs and does not traverse the other two. The second winding, used to saturate the core, surrounds both central legs. The flux linkages are thus so arranged that current changes in the interphase transformer winding induce no voltage in the saturating winding. The direct current required to saturate the core may be obtained from the rectifier output, in which case a compound rectifier results, or it may be obtained from a separate source controlled by a voltage regulator. The circuit diagram for compounding on load is shown in figure 141.

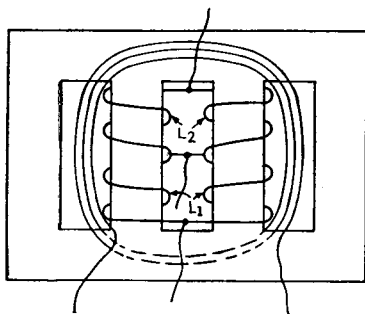

FIGURE 140.—Saturated-core interphase transformer.

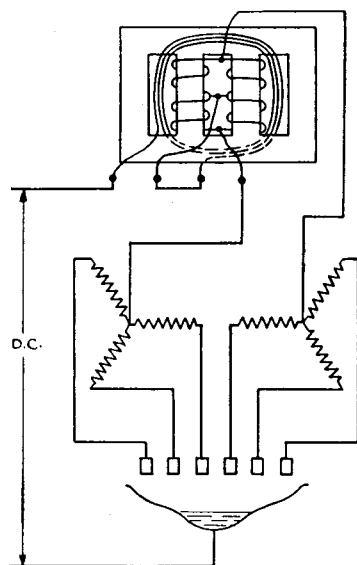

FIGURE 141.—Compound-rectifier circuit.

Voltage Control Obtainable with Compounding.

The voltage control obtainable with compounding is dependent, to a large extent, on the design of the main transformer, but it is possible to show approximately what results can be obtained.

Assume that the transformer used will have a 4 per cent drop in voltage when carrying an ordinary sine wave alternating-current load equal to its rating W for use with a rectifier. The reactance per phase to the commutating current can then be estimated and the regulation calculated as in previous chapters. Assuming that the reactance

in the double three-phase case is 50 per cent of the value obtained on an alternating-current load and that it is 40 per cent in the case of the six-phase rectifier, the curves of figure 142 are obtained. The output current is here expressed for convenience in terms of $\frac{W}{G_0}$, which is approximately equal to full-load current (G_0 is the open-circuit voltage).

The regulation curve for the compound rectifier will fall between the curves for the six- and the three-phase

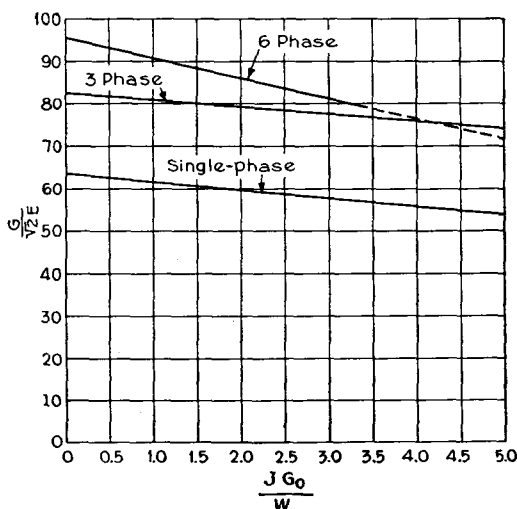

FIGURE 142.—Voltage range available for compounding

rectifiers. By increasing the saturation of the interphase transformer as the load is increased, it may be made to give high reactance at low loads and small reactance at heavy loads. As a result, the output voltage will approach that of a six-phase rectifier under heavy loads and will be nearer to that of a three-phase rectifier under light loads. It will be seen that the range of voltage available for compounding is somewhat limited if only the three- and six-phase circuits are used. It is probable, however, that the limits are sufficiently wide for the great majority of applications. A much larger variation can be obtained by going

from the single- to the six-phase connection. This transition is entirely practical but uses slightly more material than the three- to six-phase case and is, therefore, not desirable as long as the latter arrangement can be made to give the required characteristics.

Regulation Curve of Compound Rectifier.

Under extremely light loads the direct current through the interphase transformer will be so small that it would be impractical to supply a transformer having sufficient exciting reactance so that its exciting current would always be smaller than the load current. The effect, therefore, of the interphase transformer will be lost as zero load is

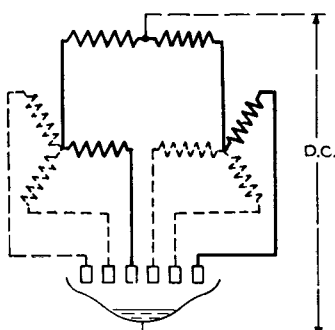

FIGURE 143.—Paths taken by commutating currents under six-phase operation.

approached and the no-load voltage will be that corresponding to six-phase operation.¹

As long as the instantaneous current in either side of the interphase transformer does not fall to zero, its reactance does not appear in the alternating-current circuits. As soon as the current in one branch of the interphase transformer is actually interrupted, however, this transformer acts as though it were inserted in the anode leads. Figure 143 shows the circuit through which the transient current flows which accomplishes the commutation of the output current between anodes. The exciting inductance of the interphase transformer is added to the leakage reactance of the windings of the main transformer to obtain the value of reactance used in calculating the regulation. For very light loads the result will therefore be a six-phase regulation curve dropping much more rapidly than that corresponding to the main transformer alone. The rapidity with which

¹ This rise in voltage is avoided in practice by arranging to have some small load always carried by the rectifier.

the voltage decreases will be dependent upon the exciting reactance of the interphase transformer.

After sufficient load current is flowing so that the interphase transformer is carrying current continuously, the output voltage will be that corresponding to the three-phase rectifier. As more load is applied, the output current flowing through the saturating winding of the interphase transformer will decrease the reactance of its main circuit. The exciting current will then rise until it is as large as the load current and continuous choke action will be lost. The

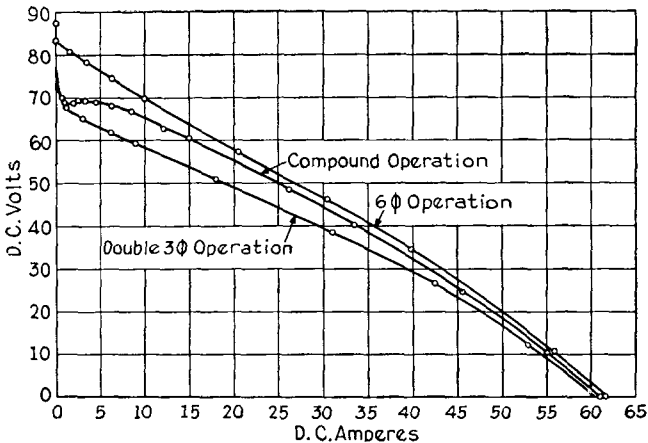

FIGURE 144.—Regulation curves of a small experimental rectifier.

voltage will then be displaced from the three-phase value in the direction of the potential corresponding to six-phase operation. By this means the voltage may be held constant over the greater part of the load range or may even be made to increase slightly with load.

Figure 144 shows the experimental regulation curves of a small compound rectifier which was arranged with sufficient reactance so that it could be short-circuited without danger. In figure 144 the load is increased to short-circuit under three conditions, with no saturation of the interphase transformer, with the compounding apparatus in operation, and with the interphase transformer short-circuited.

Although the compound curve never equals the six-phase curve except at short-circuit, the six-phase voltage is approached sufficiently to give flat compounding from light load to $6\frac{1}{2}$ amperes, which is 10 per cent of the current under short-circuit.

Figure 145 shows the results of tests on a 1000-kilowatt, 600-volt, twelve-phase rectifier, and figure 146 shows the

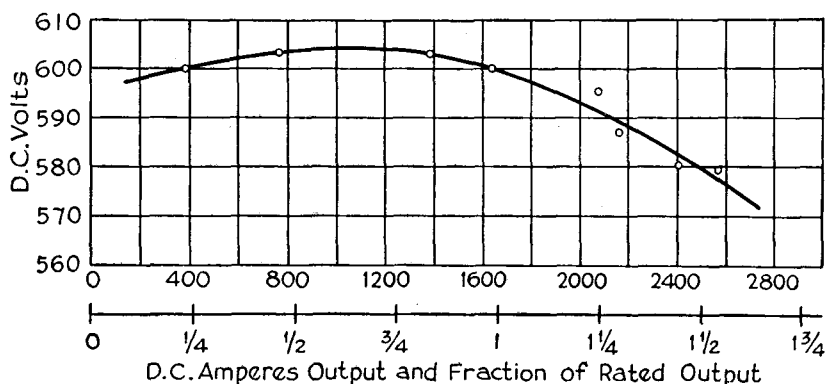

FIGURE 145.—Regulation curve of a 1000-kw. compound rectifier.

interphase transformer. Since the set is twelve-phase, there are three interphase units. The lower units each combine two groups of three phases and have direct-current saturating windings. The small top unit combines the two six-phase groups into one twelve-phase unit.

Wave Shapes Obtained with Compound Rectifiers.

Figure 147 shows the wave shapes obtained with an oscillograph when an experimental rectifier was operating as two separate three-phase units connected in parallel through an unsaturated interphase transformer. At time t_1 the secondary voltage of the phase being measured became equal to that of the preceding phase in the same three-phase group, and it began to conduct current. Between t_1 and t_2 both phases were conducting current and the reactive drops caused by the changing currents averaged the induced voltages of the two phases so that their terminal voltages

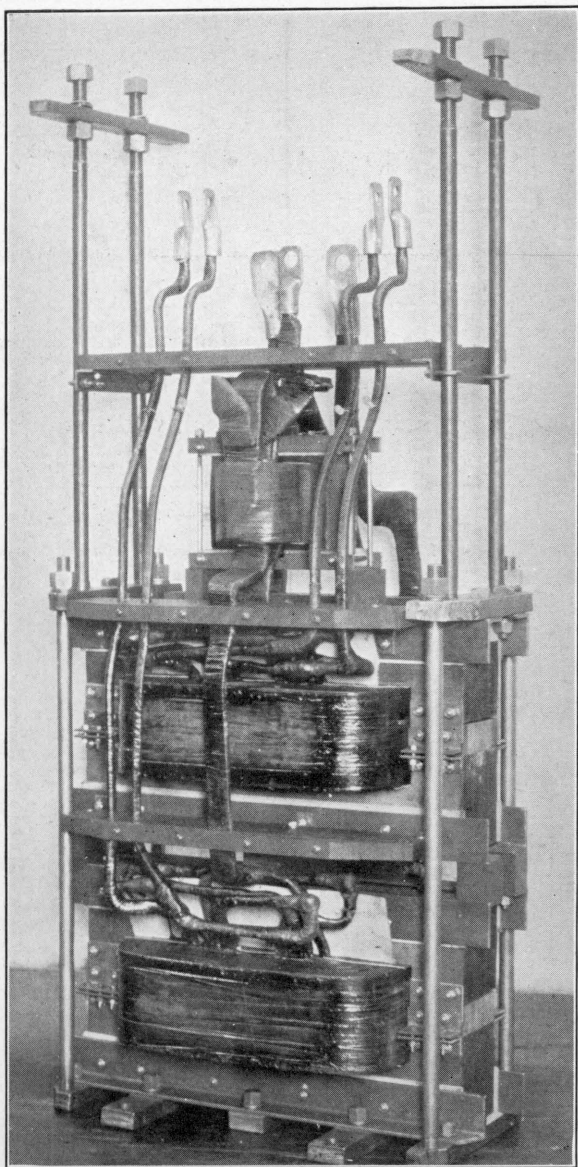

FIGURE 146.—Interphase transformer for a 1000-kw. compound rectifier.

were nearly constant. At time t_2 the current transfer was completed and the terminal voltage of the incoming phase again became equal to its induced voltage. Between

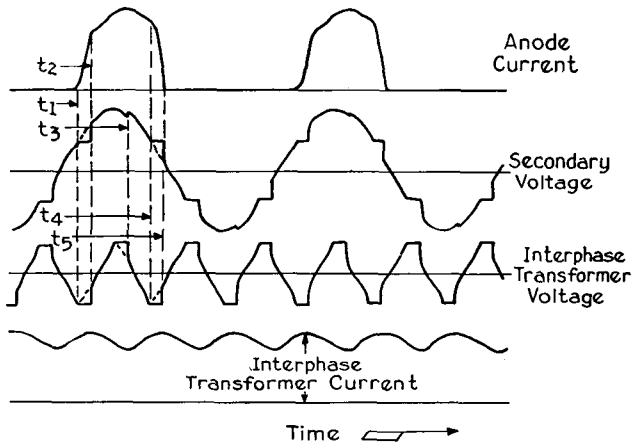

FIGURE 147.—Wave shapes obtained with interphase transformer unsaturated.

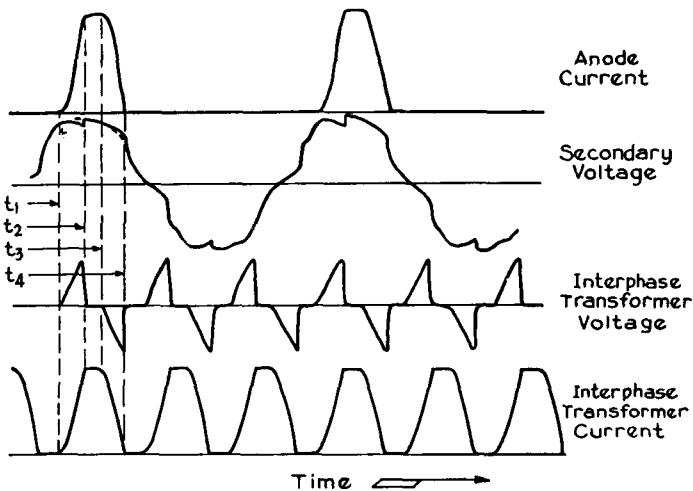

FIGURE 148.—Wave shapes obtained with interphase transformer saturated.

t_4 and t_5 the current left the phase under observation, and this time the reactive drop prevented the terminal voltage of the phase from falling as rapidly as the induced voltage until after the transfer was completed. The dotted lines

indicate the form of the secondary voltage and interphase transformer voltage waves if they had not been distorted by the reactive voltages during current transfer. The slight irregularity in the secondary voltage wave at time t_3 was caused by commutation of currents in the second three-phase group of windings and was present because of the coupling between the two groups through the transformer primary windings.

Figure 148 shows the wave shapes obtained with the core of the interphase transformer saturated. The operation is now that of a six-phase rectifier. Current is building up in the phase under observation between t_1 and t_2 and decreasing between t_3 and t_4 . No more than two anodes carry current simultaneously, and between t_2 and t_3 only one anode is conducting. The interphase transformer now carries pulses of current of the same shape as the anode pulses, but, since it carries the current of all the anodes, the pulses will be closer together. There is a voltage across the interphase transformer, through which transfer must occur, only during the time the current is transferring between anodes. As the reactance of the interphase transformer influences the period of commutation, it is apparent that the output voltage can never rise to the six-phase voltage corresponding to that of the transformer by itself. Instead, the output voltage will approach this value as the reactance of the choke is decreased by saturating it more and more, but can never reach it.

CHAPTER XIII

EFFECT OF RESISTANCE ON WAVE SHAPES, INTER-PHASE TRANSFORMER AND CHOKE EXCITING CURRENTS

In the preceding chapters the effect of resistance on the performance of rectifiers has been treated only by means of approximations which assumed that the current wave shapes were unaffected by its presence. Also, the interphase transformers and chokes have generally been assumed to have zero exciting current. It is the purpose of this chapter to consider what the effects of circuit resistance and choke-system exciting currents really are, so that the magnitude of the errors involved in the assumptions which have been used may be more clearly indicated.

Effect of Resistance on the Transfer of Current between Anodes.

When reactance alone is considered, the potential of a single anode carrying a steady current is the same as the open-circuit voltage as long as only the simpler cases without coupling between phases are considered. If there is also resistance in the circuit, the anode potential will be lowered by the drop in it due to the passage of the current and will, therefore, be less than the open-circuit value. The potentials of the inactive phases, however, will be unaffected by the resistance, and a phase, for this reason, will begin to conduct current at a time t_1 slightly in advance of the time t_0 at which the open-circuit voltages are equal, as shown in figure 149.

At the time the second phase starts carrying current, the induced voltages differ by an amount equal to the resistance drop in the phase carrying current, which makes the potentials of the two anodes equal. The voltage causing

the current to transfer between phases is the difference in the open-circuit potentials as before, but the commutating current is now limited by both resistance and reactance and will consist of a sine wave about a displaced axis having a logarithmic decrement, such as shown by figure 57. In addition, the phase of the current will be affected by the resistance. (It will be remembered that, when reactance alone is considered, the displaced current axis suffers no decrement and the commutating current lags the voltage by exactly 90 degrees.)

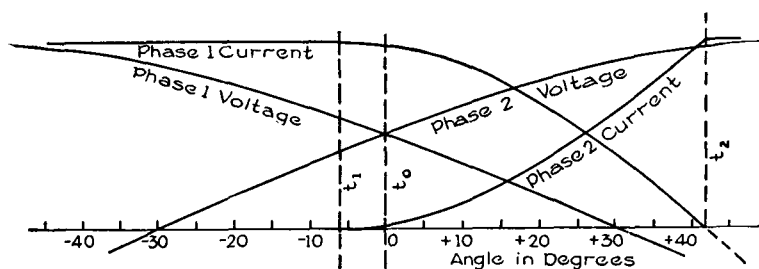

FIGURE 149.—Effect of resistance on transfer of anode currents.

The voltage between phases is $2\sqrt{2}E \sin \frac{\pi}{p} \sin \omega t$ where E is the voltage of each secondary and ωt is measured, as shown in figure 149. If the effective resistance of each phase is r and the circuit is of a type where the entire load current J is carried by one winding at a time, commutation will begin when

$$2\sqrt{2}E \sin \frac{\pi}{p} \sin \omega t_1 = -Jr,$$

$$t_1 = \frac{1}{\omega} \sin^{-1} \left(\frac{-Jr}{2\sqrt{2}E \sin \frac{\pi}{p}} \right) \quad (55)$$

The alternating current which flows will be

$$i_{a.c.} = \frac{\sqrt{2}E \sin \frac{\pi}{p} \sin \left(\omega t - \tan^{-1} \frac{X}{r} \right)}{\sqrt{r^2 + X^2}}, \quad (56)$$

where $X = \omega L$ is the equivalent reactance per phase, and the damped direct current for the incoming phase will be

$$i_{d.c.} = \left\{ -\frac{J}{2} - \frac{\sqrt{2}E \sin \frac{\pi}{p} \sin \left(\omega t_1 - \tan^{-1} \frac{X}{r} \right)}{\sqrt{r^2 + X^2}} \right\} e^{\frac{-r(t-t_1)}{L}}. \quad (57)$$

The term $\frac{-J}{2}$ arises from the fact that at the time commutation commences there may be considered to be a current $\frac{J}{2}$ flowing from each anode through the choke in the output circuit and another current $\frac{J}{2}$ flowing from the active anode and entering the one just commencing to carry current. The two components which leave the anodes and pass through the choke will be held constant by its action, but the component of direct current passing through the circuit in which commutation is taking place will have a decrement. The second term of equation (57) represents the transient due to the starting of the alternating current given by equation (56).

Adding the current components, there results for the two anode currents

$$i_1 = \frac{J}{2} - \frac{\sqrt{2}E \sin \frac{\pi}{p} \sin \left(\omega t - \tan^{-1} \frac{X}{r} \right)}{\sqrt{r^2 + X^2}} + \left\{ \frac{J}{2} + \frac{\sqrt{2}E \sin \frac{\pi}{p} \sin \left(\omega t_1 - \tan^{-1} \frac{X}{r} \right)}{\sqrt{r^2 + X^2}} \right\} e^{\frac{-r(t-t_1)}{L}}, \quad (58)$$

$$i_2 = \frac{J}{2} + \frac{\sqrt{2}E \sin \frac{\pi}{p} \sin \left(\omega t - \tan^{-1} \frac{X}{r} \right)}{\sqrt{r^2 + X^2}} - \left\{ \frac{J}{2} + \frac{\sqrt{2}E \sin \frac{\pi}{p} \sin \left(\omega t_1 - \tan^{-1} \frac{X}{r} \right)}{\sqrt{r^2 + X^2}} \right\} e^{\frac{-r(t-t_1)}{L}}. \quad (59)$$

It will be seen that, for values of resistance small in comparison with the reactance, very little error is introduced by neglecting its effect on the wave forms.

Interphase Transformer and Choke Voltages and Exciting Currents.

The voltages which are applied to the interphase transformers and chokes under light-load conditions have already been considered in Chapter VII. As soon, however, as the loads become heavy enough so that commutation of the currents requires considerable time, these voltages will change. Inasmuch as the shapes of the output voltage waves can be readily determined, it is not very difficult to arrive at a close value for the voltage applied to the choke system in any particular case. A lengthy discussion of the problem, therefore, will not be attempted. By analyzing the voltage into an harmonic-series form and calculating the currents due to the different components, a satisfactory value for the exciting current can usually be obtained using only one or two terms.

Effect of Interphase-transformer and Choke Exciting Currents on Regulation.

The interphase-transformer and the choke exciting currents can affect regulation in several ways. By drawing a variable current from the active phases, the voltage of these phases is disturbed, which will cause a slight change in the time at which the phases enter and leave the conducting group, as well as affecting the average value of their voltage during the conducting period. Also, the various losses in the choke system must be compensated for in some manner and this will have its effect on the output voltage.

The exciting currents for the choke system meet the exciting reactance of the interphase transformer and choke, and the leakage reactance of the phases carrying current. As the latter reactance will be quite small compared with the former, it is apparent that most of the ripple in the output voltage will appear across the choke system and that only a small part of it will fall across the main transformer windings. The effect on the wave shapes of the anode voltages will therefore be small and the error resulting from neglecting it will be very slight. The current

wave shapes will often be found to have a noticeable distortion but the discussion is based on wave forms which result in a given average value and this is not affected by the ripple. Also the transfer of current between anodes will not be materially affected, hence the effect of the current ripple due to incomplete choke action is of little moment.

The losses in the choke system are of several varieties. First, there is the loss due to the steady direct current, and there can be no question of how this should be treated.

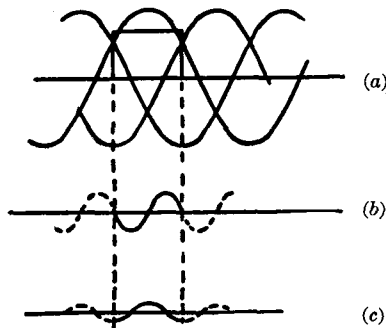

FIGURE 150.

Then there are the excitation losses which may be divided into iron and copper losses. The passage of the exciting current through the main transformer windings will also cause a small loss there. Against these losses there can be balanced a possible increase in input, for the exciting current will flow through the main transformer windings by first one path and then another, depending on which anodes happen to be active, and the integral of instantaneous power input from the alternating-current lines may be a positive quantity, even though the frequencies are different.

Figure 150 illustrates this point. The wave shapes of a three-phase rectifier, neglecting the effect of transformer reactance on the current wave, are shown in *a*. The principal component of the choke exciting current is shown by *b* and it is obvious that the integral of the instantaneous

product of this current and the voltage of the conducting phase is zero. There should be, however, a small component of the exciting current in the phase shown in *c*. This represents an input of power from the alternating-current source.

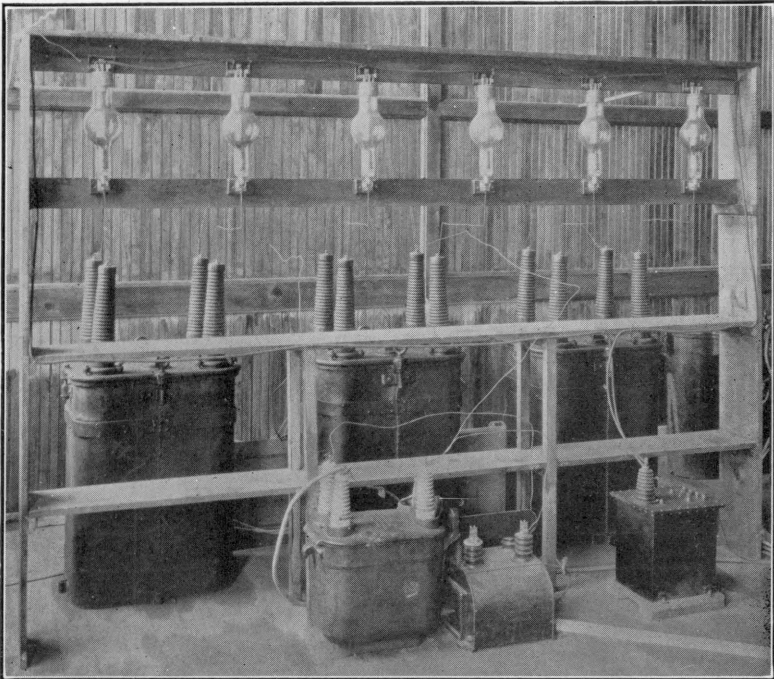

FIGURE 151.—Kenotron rectifier set, 20 kilowatts.

Example of Circuit Calculations in Which Resistance and Choke-system Exciting Currents Are Considered.

The calculation of the performance of a kenotron rectifier of the type used in supplying high-powered radio sets provides a good example of many of the points discussed in this chapter. The apparatus is shown in figure 151 and the connections are double three phase, as shown in figure 152.

In figure 151 the six kenotrons appear at the top of the picture, and the three high-tension transformers which

supply the power are beneath the rectifiers and slightly behind them. In the foreground, from left to right, are the interphase transformer, a potential transformer used in measuring its voltage, and a small transformer used to light the filaments of the kenotrons.

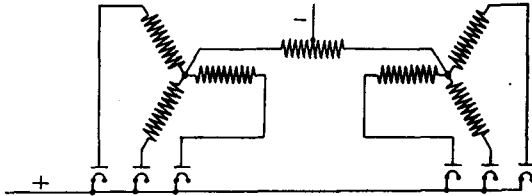

FIGURE 152.

The anode-current waves were calculated from equations (58) and (59) and are shown in figure 153 for different load currents. These waves were then analyzed by a process of step-by-step integration, as illustrated in Table XII, and final calculations made, as shown in Table XIII. The output is determined by deducting the losses from the input, and the output voltage is obtained by dividing the

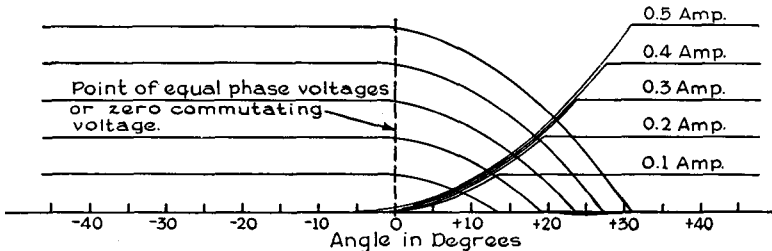

FIGURE 153.—Anode current waves of circuit shown in figures 151 and 152.

power by the current. The calculations of the effect of the interphase-transformer exciting current are only rough approximations, but the accuracy is sufficient for the needs of the case and the table shows the different things which may be considered and indicates roughly their relative importance. Figures 154 and 155 show the calculated performance and the results obtained by tests, and it will be seen that they are in close agreement.

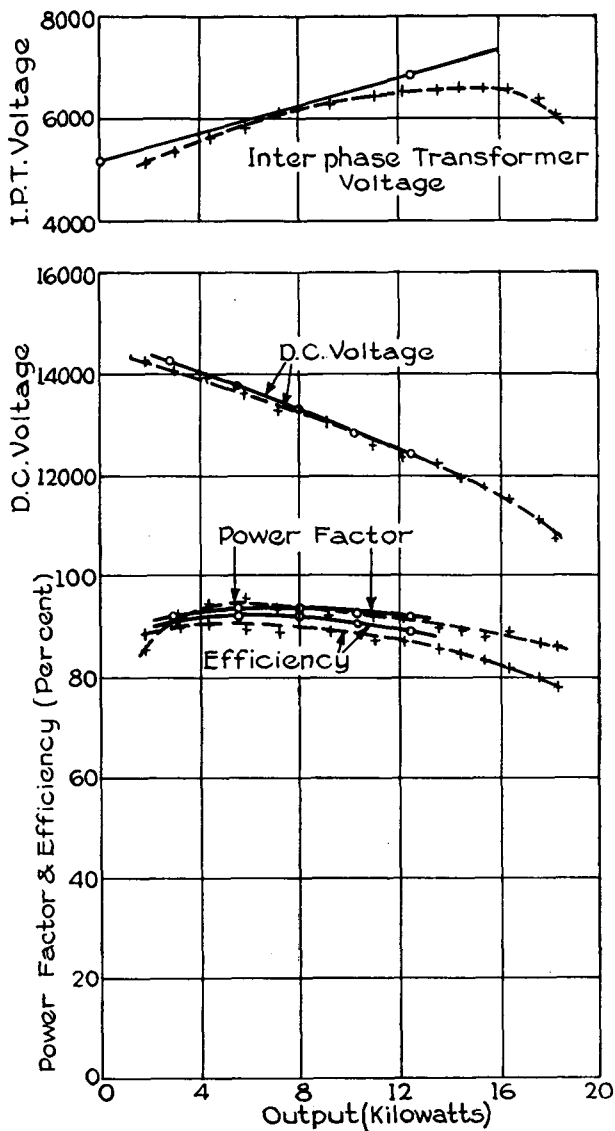

FIGURE 154.—Characteristics of rectifier shown in figure 151.

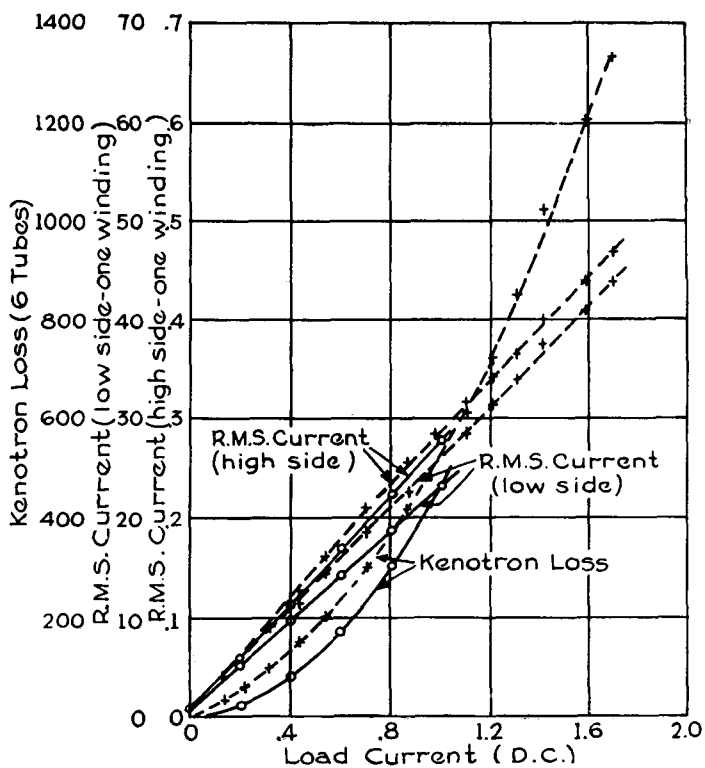

FIGURE 155.—Characteristics of rectifier shown in figure 151.

TABLE XII
ANALYSIS OF RECTIFIER PLATE CURRENTS
Load 0.4 Ampere (for Each 3 ϕ Group)

θ	Sin ($\theta + 30^\circ$)	i	$i \sin$ ($\theta + 30^\circ$)	i^2	
0	0.500	0.008	0.004	0.000	<i>High-tension (secondary) side</i>
6	0.588	0.039	0.023	0.002	Unity power-factor component
12	0.669	0.100	0.067	0.010	= $0.1044 \times \sqrt{2}$
18	0.743	0.194	0.144	0.038	= 0.1476 ampere root-mean-square
24	0.809	0.313	0.253	0.098	Total current = $\sqrt{0.04958} = 0.2227$
30	0.866	0.400	0.346	0.160	ampere root-mean-square
36	0.914	0.400	0.366	0.160	Direct current = 0.1333 ampere
42	0.951	0.400	0.380	0.160	Wattless alternating current
48	0.978	0.400	0.391	0.160	= $\sqrt{0.04958 - 0.1332^2 - 0.1476^2}$
54	0.995	0.400	0.398	0.160	= 0.1003 ampere root-mean-square
60	1.000	0.400	0.400	0.160	Power factor = $0.1476 \div 0.2227 =$
66	0.995	0.400	0.398	0.160	66.3 per cent
72	0.978	0.400	0.391	0.160	<i>Low-tension (primary) side</i>
78	0.951	0.400	0.380	0.160	Unity power-factor component =
84	0.914	0.400	0.366	0.160	0.2952 ampere root-mean-square
90	0.866	0.400	0.346	0.160	Total current = $\sqrt{0.09916} = 0.3149$
96	0.809	0.400	0.324	0.160	ampere root-mean-square
102	0.743	0.400	0.291	0.160	Direct current = 0
108	0.669	0.400	0.268	0.160	Wattless alternating current
114	0.588	0.400	0.235	0.160	= $\sqrt{0.09916 - 0.2952^2}$
120	0.500	0.392	0.196	0.154	= 0.110 ampere root-mean-square
126	0.407	0.360	0.147	0.130	Power factor = $0.2952 \div 0.3149 =$
132	0.309	0.299	0.092	0.095	93.7 per cent
138	0.208	0.202	0.042	0.041	(Notice that in calculating the primary
144	0.105	0.082	0.009	0.007	currents no allowance has been made
150	0	0	0	0	for the transformation ratio.)
156	-0.105	0	0	0	
354		0	0	0	
Sum.....	7.989	6.263	2.975		
Average.....	0.1333	0.1044	0.04958		

TABLE XIII
CALCULATION OF RECTIFIER PERFORMANCE

Alternating potential (primary).....	110 volts
Transformer ratio.....	114:1
Resistance of each high-tension winding.....	1280 ohms
Resistance of two low-tension windings in parallel.....	0.034 ohms
Resistance of each kenotron (approximate).....	1000 ohms
Leakage inductance (from high potential side, one winding).....	12.2 henries
Exciting current at 110 volts (3 ϕ).....	1.97 amperes
Exciting power at 110 volts (3 ϕ).....	166 watts
Zero power-factor component of exciting current at 110 volts (3 ϕ).....	1.765 amperes
Resistance of interphase transformer.....	33 ohms
Filament loss.....	1060 watts

Neglecting Interphase Transformer and Excitation Losses

Output current (amperes).....	2m*	0.200	0.400	0.600	0.800	1.000
Root-mean-square current (secondary, one winding).....	0.578m	0.0567	0.1126	0.1683	0.2227	0.2773
Loss (secondary, six circuits including tubes).....	4,580m ²	44	174	387	678	1,052
Root-mean-square current (primary, two windings).....	93m	9.14	18.16	27.15	35.9	44.75
Loss (primary, all circuits).....	883m ²	8.53	33.7	75.2	131.5	204
Total I^2R losses.....	5,463m ²	52.5	208	462	810	1,256
Unity power-factor amperes (primary, two windings).....	88.9m	8.78	17.35	25.7	33.65	41.6
Zero power-factor amperes (primary, two windings).....	27.1m	2.575	5.36	8.78	12.54	16.53
Input at 110 volts (three transformers).....	29,300m	2,900	5,725	8,480	11,100	13,730
Output.....	29,300m	2,847.5	5,517	8,018	10,290	12,474
Output voltage.....	14,650	14,238	13,780	13,350	12,860	12,474
Line current (unity power-factor).....	154m	15.22	30.05	44.5	58.25	72.0
Line current (zero power-factor).....	47m	4.46	9.28	15.22	21.7	28.62
Line current (root-mean-square).....	161.2m	15.84	31.45	47.0	62.2	77.5
Power factor.....	95.6	96.0	95.5	94.7	93.7	93.0
Efficiency.....	100 %	98.2	96.3	94.7	92.7	90.9

TABLE XIII.—(Continued)

Including Interphase Transformer and Excitation Losses

Estimated interphase-transformer voltage.....	5,190	5,522	5,854	6,186	6,518	6,850
Interphase-transformer excitation loss...	60	67.5	75.0	83.0	93.0	102
Interphase-transformer copper loss.....	0	1.3	5.3	11.9	21.2	33
Unity power-factor current drawn to cover interphase-transformer excitation loss (secondary).....						0.00089
Zero power-factor current drawn from alternating-current side for interphase-transformer excitation (line value).....		0.99	1.05	1.10	1.165	1.22
Additional power drawn to cover interphase-transformer excitation loss.....		67†	67†	67†	67†	67
Additional losses in main transformer circuits due to interphase-transformer excitation current.....		1.0	1.1	1.2	1.4	1.5
Resultant net loss in output.....		2.8	14.4	29.1	48.6	69.5
Resultant drop in output voltage.....		14	36	48.5	61	69.5
Output voltage.....		14,224	13,742	13,301	12,799	12,404
Total input (including iron losses in main transformers).....	166	3,133	5,958	8,713	11,333	13,963
Total output.....	0	2,845	5,503	7,989	10,241	12,404
Efficiency.....	0	90.8	92.3	91.7	90.3	88.9
Unity power-factor component of line current.....	0.87	16.45	31.25	45.7	59.45	73.25
Zero power-factor component of line current.....	1.77	7.22	12.10	18.09	24.64	31.61
Root-mean-square value of line current.....	1.97	17.98	33.5	49.1	64.3	79.8
Power factor.....	44.2 %	91.5	93.3	93.1	92.5	91.8

Including Filament Losses

Total input.....		4,193	7,018	9,773	12,393	15,023
Total output (as before).....	0	2,845	5,503	7,989	10,241	12,404
Efficiency.....	0	67.8 %	784	81.8	82.7	82.6

* m is an infinitesimal.

† Rough estimate.

INDEX

	PAGE
A	
ANODE REACTORS	
voltage control by	201
ANODES	
conditions of ionization at	43
no interference between in mercury arc	24
ARC DROP	
effect on parallel operation	50
experimental curve	47
instantaneous value	49
ARC STREAM	
losses in	42
ARC-BACK	
below normal value of load	57
connection with size of tube	55
effect of wave form and frequency on	69
of mercury arc rectifiers	54, 64
point in cycle at which arc-back occurs	71
prediction of arc-back	80

B

BATTERY-CHARGING RECTIFIERS	
description of	117
effect of arc drop	133
effect of primary reactance	124
for Edison batteries	135
for lead storage batteries	131
heating value of current	133
operation with reactance in anode leads	118
regulation with reactance in anode leads	122, 123
regulation with primary reactance	126, 129
short circuit output current	123

	PAGE
BATTERY-CHARGING RECTIFIERS	
transformers for	130
voltage dependent on type of load	130
BREAKDOWN	
effect of electrode shapes and spacing on	78
of mercury vapor	74
C	
CATHODE SPOT	
as source of electrons	23
instability of	41
mechanism of	38
COMMUTATION	
effect on output voltage	111
effect on transformer heating	114
of anode currents	108
COMPOUND RECTIFIERS	
possibility of	203
regulation of	208
voltage obtainable	206
wave shapes of	210
CONDENSING CHAMBER	
design of	46, 55
function of	44
COOLING	
effectiveness of various means of	61
of glass	60
of rectifiers	59
CURRENT WAVES	
analysis of	93
CURRENT-DIVIDING COMPENSATORS	
description of	198

D

DOUBLE THREE-PHASE CIRCUIT	
description of	99
regulation of	154, 167
voltage rise under light loads	155

	PAGE
E	
EMISSION OF ELECTRONS	
from hot metals.....	6
from mercury.....	23
F	
FADING	
nature of.....	58
FAILURE OF MERCURY ARC RECTIFIERS	
arc-back at higher voltages.....	54
at low voltages.....	51
FILAMENTS	
emission.....	6
heating loss.....	12
in tungar rectifiers.....	20
material.....	5
FLASHING	
akin to arc-back.....	57
H	
HEATING	
effect of commutation on transformer heating.....	114
of battery chargers.....	133
of transformers for rectifier service.....	95
rate of heating of glass rectifier bulbs.....	62
I	
INFINITE PHASE RECTIFIER	
characteristics of.....	139
description of.....	136
INTERPHASE TRANSFORMER	
description of.....	102
INVERSE CURRENT	
of mercury arc rectifiers.....	66
IONIZATION	
conditions at anodes.....	43

	PAGE
IONIZATION	
movement of ions and electrons in tungar rectifier.....	18
of argon.....	16
recombination of ions and electrons.....	17
IRON TANK RECTIFIERS	
arrangement of parts.....	33
development of.....	29
insulation of cathode.....	33
porcelain anode seals.....	31
without clamped joints.....	37
K	
KENOTRON RECTIFIERS	
characteristics of.....	11
description of.....	3
field of usefulness.....	13
L	
LIFE	
of glass rectifier tubes.....	59
LOSSES	
anode losses.....	44
effect on regulation.....	151
in arc stream.....	42
M	
MERCURY ARC RECTIFIERS	
development of.....	25
development of iron tanks.....	29
field of usefulness.....	23
life of glass tubes.....	59
no interference between anodes.....	24
seals for glass rectifiers.....	26
MERCURY VAPOR	
breakdown of.....	74
O	
OPERATING CONDITIONS	
of rectifier tubes.....	64

	PAGE
OUTPUT VOLTAGE	
ripple in.....	90
table of voltage ratios.....	91
value from fundamental wave shapes.....	89

P

PARALLEL OPERATION	
effect of arc drop on.....	50, 198
of complete rectifiers.....	199
POWER FACTOR	
nature of.....	98
value of.....	98

R

RECTIFIER CHARACTERISTICS	
table of.....	99, 100, 101, 103
REGULATION	
correction for arc drop and resistance losses.....	151
general methods used in calculating.....	116
maximum loads carried with straight line regulation curves.....	200
negative resistance of mercury arc.....	198
of battery chargers.....	122, 123, 126, 129
of compound rectifiers.....	208
of double three-phase rectifiers with reactance in pri- maries or supply lines.....	154, 167
of rectifiers with reactance in secondary windings.....	136, 148
of six-phase rectifiers with reactance in primaries or sup- ply lines.....	176, 183, 192
straight line regulation curve.....	112
voltage control by anode reactors.....	201
voltage rise under light loads.....	155
RESISTANCE	
correction of regulation for.....	151
effect of on wave shapes.....	214
RIPPLE	
in output voltage.....	90

	S	PAGE
SEALS		
cathode insulation.....		33
for glass rectifier bulbs.....		26
glass, for iron tank rectifiers.....		37
porcelain anode seals.....		31
SINGLE PHASE RECTIFIER		
with direct-current choke.....		85
without direct-current choke.....		84
SIX PHASE CIRCUIT		
regulation of.....	176, 183,	192
SPACE CHARGE		
description of.....		7
law of.....		8
loss due to.....		11
T		
THREE-PHASE RECTIFIER		
fundamental wave shapes.....		87
TRANSFORMERS		
heating of.....		95
reactance of.....		113
TRIPLE SINGLE PHASE CIRCUIT		
description of.....		104
TRIPLE-STAR CIRCUIT		
description of.....		106
TUNGAR RECTIFIERS		
description of.....		15
performance of.....		21
U		
UTILITY FACTOR		
definition of.....		98
V		
VACUUM		
signs of poor vacuum and high vapor pressure.....		52
testing glass tubes for.....		53

INDEX

233

W

PAGE

WAVE SHAPES

fundamental wave shapes of rectifiers..... 83

Y

Y-STAR CIRCUIT

description of..... 105

Y-STAR-TERTIARY CIRCUIT

description of..... 106