

TRANSISTOR TECHNIQUES

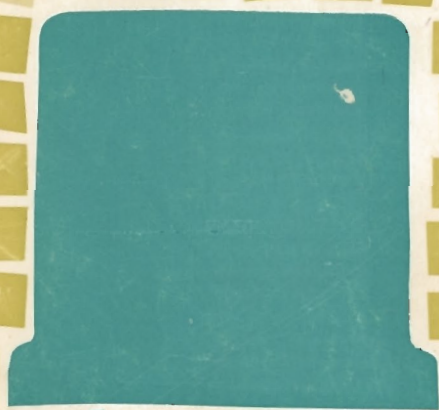

muneef alwan

paperback
library no. 61



\$1.50

52



TRANSISTOR TECHNIQUES

published by gernsback library, inc. new york, n. y.

First Printing—November 1956
Second Printing—July 1958
Third Printing—March 1959
Fourth Printing—February 1960



© 1956 Gernsback Library, Inc.
All rights reserved under Universal,
International, and Pan-American
Copyright Conventions.

Library of Congress Catalog Card No. 56-10946

contents

chapter

page

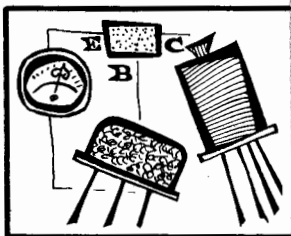

1

Protecting transistors

Construction of a control panel for testing transistors. Current drain. Operating values. Effect of temperature. Protecting transistor leads. Battery Polarity. Layout board. Technique used to identify transistors. Simple resistance measurements on transistors. Current limitations.

9

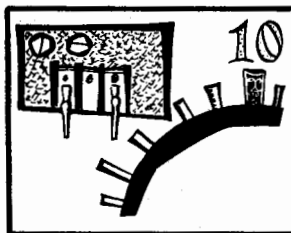

2

Testing transistors

Current gain. Alpha. Beta. Basic operation of grounded base and grounded emitter circuits. Junction transistor checker. Calibration and use of transistor checker. Transistor checker test patterns. Testing transistors with an ohmmeter. Transistor check circuit. Transistor check procedures.

17

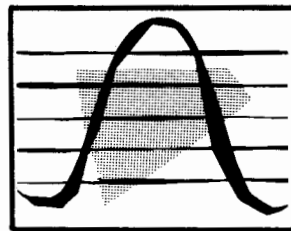

3

Transistor performance

Stabilizing the transistor. Current and voltage feedback. Collector load line. Low-frequency transistor circuits. Alpha and beta cutoff. The tetrode transistor. Measuring tetrode transistor dc characteristics. Measuring small-signal current gain tetrodes. Tetrode amplifier. Tetrode oscillator.

33

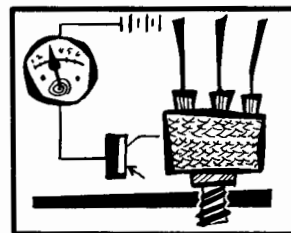

4

Transistor measurements

Transistor characteristics. Leakage current. Current gain. Output impedance. Test Methods. Measuring dc leakage. Incremental dc current gain. Germanium junction transistors. Transistor noise. Duality. Output impedance. Power transistors. Silicon junction transistors.

45

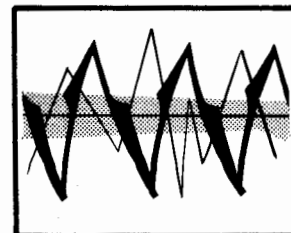

5

Oscillators and triggers

Analogous vacuum-tube and transistor circuits. Phase inversion. Transistorized multivibrator. Two-terminal sine-wave generator. Combined multivibrator and sine-wave generator. Trigger circuits. Bistable multivibrator. One-shot multivibrator. Blocking oscillator.

59

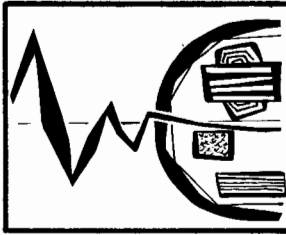

6

Transistor dc transformer

Advantage of the dc transformer. How a dc transformer functions. Schematic of the transistorized dc transformer. Load tests. Optimum output power. Ripple. Filtering the ripple. Applications of the dc voltage multiplier.

71

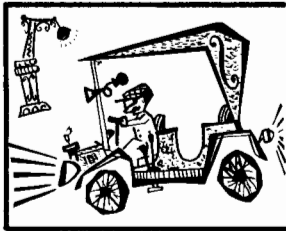

7

Auto-light control

Automation of automobile headlights, parking lights, tail and dash lights. Schematic for transistor auto-light control. Relay operation. Control box assembly. Circuit components. Characteristics of the CK722. Wiring of the light control box. Mounting the selenium photocell.

77

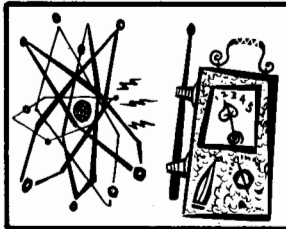

8

Geiger counter

Circuit operation of the transistorized geiger counter. Construction details. Need for voltage regulation. Polarity of the G-M tube. Rebuilding the transformer. Using the Geiger counter. Underchassis view showing the major parts. Expected operating life of the unit.

87

Index

93

introduction

THERE has been, and still is, a tendency on the part of electronics technicians and engineers to make comparisons between vacuum tubes and transistors. While such comparisons are inevitable, they may lead to the completely erroneous conclusion that transistors can be treated just as vacuum tubes are, that vacuum-tube techniques are synonymous with transistor techniques. While useful analogies can be made between vacuum-tube and transistor circuits, yet the transistor is not an outgrowth of vacuum-tube work. It is an entity in itself. It is separate and independent, and must be treated as such.

Transistors have their own peculiarities. In many instances they possess considerable advantages over vacuum tubes, but at the present state of the art transistors have very definite limitations. It is the function of this book to help the reader become familiar with some of the behavior characteristics of transistors. Thus, the chapters that follow describe transistor performance, transistor tests and checks.

The small size of transistors and their very economical power requirements make their use in certain types of circuitry practically obvious. In devices where weight is an important factor and where the size of battery units must be kept small, the transistor has joined forces admirably with miniaturized components. As an example, in hearing aids the transistor has practically superseded vacuum-tube operation. Another logical source of employment for transistors is in portable receivers.

The argument has been set forth that transistors will replace vacuum tubes. That may or may not be the case. At one time it was thought that the radio receiver would make all phonograph equipment obsolete. Television was supposed to have completely eliminated movies. It may very well be that transistors will supple-

ment, not supplant vacuum tubes, and that each type, vacuum tubes and transistors, will perform those jobs for which they are especially well fitted.

In any event, the transistor is here to stay. And since that is so, then electronics technicians and engineers must learn how to work and live with transistors, and become as familiar with them and understand them as well as they do vacuum tubes.

No claim is made that this small book can tell you everything there is to know about transistors, nor could we do so if this book were three times as large. Transistor electronics is probably one of the fastest growing branches of this industry. It is inevitable that new manufacturing techniques will be developed. New transistor types are being released regularly. But while this book cannot possibly be complete, yet the editors believe that it is a step in the right direction. To the man who has learned something of transistor theory, practical applications and use of transistors is the next logical step. And it is the job of this book to help the reader take that step.

The publishers gratefully acknowledge the courtesy of The Institute of Radio Engineers for permission to include part of an article taken from Proceedings of the IRE on the tetrode transistor amplifier and oscillator (written by R. L. Wallace, Jr., L. G. Schimpf and E. Dickten). The material appearing in this book is a collected group originally appearing in RADIO-ELECTRONICS Magazine. The authors are: Edwin Bohr, Joseph Braumbeck, Henry A. Kampf, Thomas G. Knight, Edward D. Padgett, Sol D. Prensky, I. Queen, Harold Reed, Stan Schenkerman, J. R. Steen, and Rufus P. Turner.

Gernsback Library, Inc.
New York, N. Y.

transistor techniques

The experience gained in working with vacuum tubes does not always carry over into the realm of transistors. While transistor circuits can be designed and used based on the principle of analogy to vacuum tubes, yet transistors must be handled in their own way, must be wired, tested, protected and operated in a manner often at complete variance to vacuum-tube techniques. The four chapters that follow describe how to use the new methods and techniques that are required by transistors.

protecting transistors

TRANSISTORS are easily ruined, but you can eliminate all possible conditions that might prove disastrous to transistors when used in untried experimental circuits. This is done by having complete variable control over all battery potentials applied to transistors. This is especially desirable if the battery voltages are near or above the maximum rating of the transistor. This condition is satisfied by the setup shown in Fig. 101-a. A variation using two controls, providing individual adjustment of the positive and negative potentials of the battery is shown in Fig. 101-b.

Construction of the control panel

The small 4 x 2 $\frac{1}{4}$ -inch bakelite panel (Fig. 102) on which is mounted the on-off switch, variable control, fuse holder and terminals, is equipped with two small angle brackets, slotted at one end so they may be slipped under the battery binding posts. The supply leads from the battery have spade lugs that also slip under the battery posts. Thus, with the 5308 Burgess battery, used in this instance, the supply potential is variable from 0 to 22.5 or 45 volts. When the battery is run down, the panel and lugs may be slipped onto a new battery of the same type. Also, the polarity of the output terminals of the panel can be reversed simply by slipping the slotted brackets and lead lugs under the battery binding posts from the opposite side of the battery. The small fuse in the circuit is of the instrument protection type. Available in many different sizes, it should be chosen according to the maximum current rating of the transistors in the circuit.

Current drain

The current drain on the battery, limited by the 250,000-ohm control at 22.5 volts, will be about 90 microamperes; at 45 volts, 180 microamperes. Actual measured currents are a little under these Ohm's-law figures. A heavy-duty battery of the type shown is usually not required for transistor applications. However, this type has a capacity that is adequate for most experimental work. This same idea, of course, is applicable to any type battery available and even lower current drain can be obtained with a higher resistance control. With a 500,000-ohm potentiometer across 45 volts, the current drain will be around 90 microamperes; while using the 22.5-volt tap, the current will be under 45 microamperes.

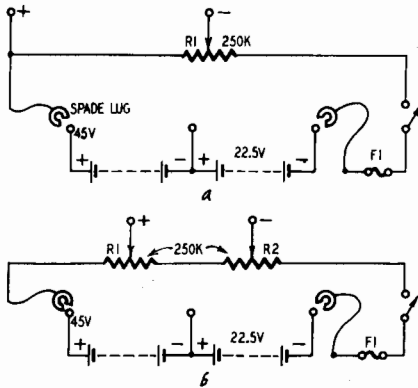

Fig. 101-a.-b. Shown above are two circuits that can be used for obtaining variable battery voltages for transistors.

If the transistor circuit being tested is to be developed into a permanent device, after the correct operating potentials are established, small batteries with voltages near the correct values may then be substituted for the test battery.

In dealing with untried transistor circuits, particularly when working near maximum rated values, it is unwise to obtain these values instantaneously. Approach them gradually.

Operating values

It is necessary to know all the operating values of a circuit, not just the current flowing through a single path in the transistor. A vacuum-tube voltmeter should be used to check battery voltages; dc voltmeters of at least 1,000 ohms-per-volt can be used if the voltage drop due to loading can be tolerated. When working close

to the maximum voltage rating, be careful that this rating is not exceeded when the load of the voltmeter is removed from the circuit. Low-range milliammeters or microammeters are inserted in the three current paths of the transistor to give constant indica-

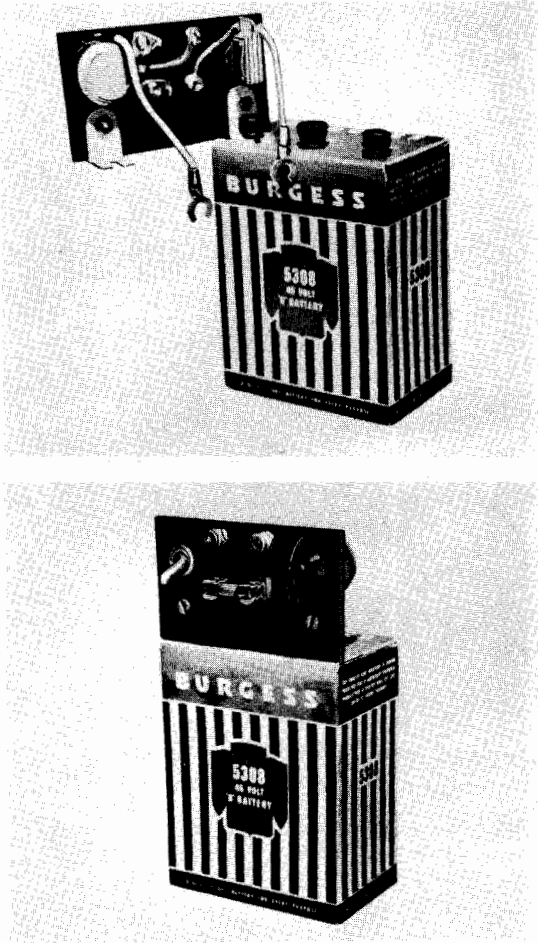

Fig. 102. These photos are front and rear views of the voltage-control unit illustrated in Fig. 101-a. The unit is mounted directly on the battery.

tion of the operating conditions with changes in component parts of the circuit and adjustments.

The layout used in developing a transistor audio amplifier (see Fig. 103) is a typical haywire breadboard setup. Nevertheless, the transistors are protected.

Effect of temperature

Radio technicians and experimenters are aware of the devastating effect of extremely high temperatures on germanium diodes because they have been widely used. Transistors are similarly affected. Heat from the soldering iron must be dissipated so it is not carried into the transistor via the leads. If the transistor is being wired into a circuit permanently, each lead may be gripped between the iron and transistor by a pair of long-nose pliers to

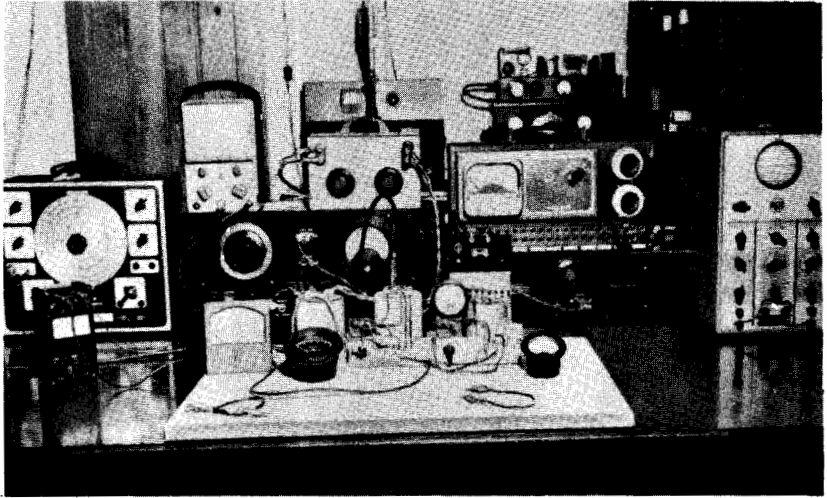

Fig. 103. Layout used for transistor experiments. It may seem haywire-looking, but it serves the purpose and it saves transistors.

reduce heat transmission. Where transistors are to be used repeatedly in experimental circuits, the mountings shown in Fig. 104 may prove helpful.

To the left is shown a Raytheon CK722 diffused junction, p-n-p transistor with its 2 x .016-inch leads and a miniature socket (Cinch Nos. 14148 or 14273 may be used). Even with a socket a small soldering iron should be used quickly. Two methods used to protect the CK722 in numerous experimental circuits are shown at the right of the picture. One way is to use the full length of the leads, threading them down through and under a narrow strip of insulating material, then up through the opposite end, fanning the ends for soldering into any circuit, and applying cellulose cement to obtain rigidity. This also prevents breakage of the leads where they enter the transistor. Should they break at the end of the insulating strip, additional leads can be soldered on without

damage to the transistor. The other mounting shown is a square of bakelite with three relatively large soldering terminals. The transistor leads are cut to suitable size, covered with spaghetti tubing and soldered to the terminals. The bakelite square is always mounted so that the terminals are above the transistor leads to minimize heat transfer to the transistor.

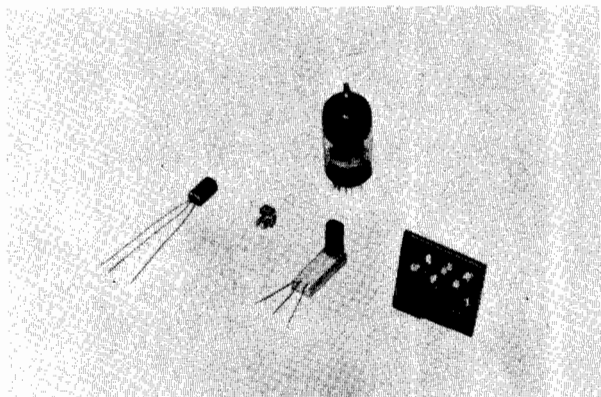

Fig. 104. This photo shows (left to right) a CK722 transistor, a Cinch socket and two methods of mounting transistors. The miniature tube in the photo indicates relative sizes.

Battery polarity

When soldering the transistor leads into a circuit, *observe battery polarity*. Incorrect polarity can easily damage a transistor permanently.

Layout board saves time

When experimenting with transistor circuits you will find that the breadboard layout in Fig. 105 will save you hours of work soldering and unsoldering connections.

Cut a 4-inch square from sheet bakelite, $\frac{3}{16}$ or $\frac{1}{4}$ inch thick. Drill eight holes for the Fahnestock clips and four holes for the mounting feet. The holes for the transistor mounting clips are 120° apart on the circumference of a circle having a radius of $\frac{7}{8}$ inch. Assemble the clips and feet as shown in Fig. 105. This panel provides for straightforward wiring. In a matter of seconds you can change any part of the wiring. By reorienting the socket you can change the basic circuit from grounded-base to grounded-collector or grounded emitter. Transistor socket leads should be spaced 120 degrees apart so that they will fit directly into the clips.

You can use General Cement No. 6302 clips, $\frac{3}{4}$ inch long. Fahnestock No. 533 clips are the same size and may also be used. If you have larger clips on hand, you can put them to work on a little larger panel.

By following these suggestions many tried and untried transistor circuits can be investigated with no transistor tragedies.

Identifying transistors

The transistor industry has grown rapidly with new processes developed daily and new types of transistors being put on the market

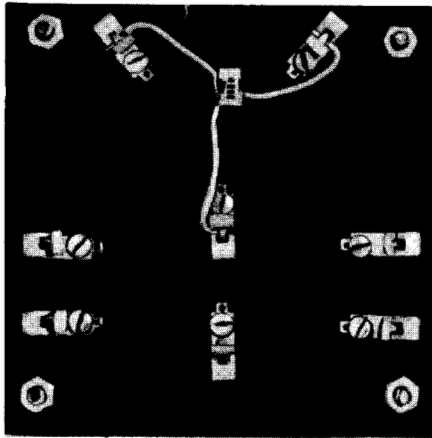

Fig. 105. *This experimental layout is a work and time saver.*

every few weeks. However, very little energy has been directed at standardizing transistor types or lead designation with the result that almost every manufacturer has a different way of identifying his transistors. This necessitates having a complete manufacturers' data sheet for each type of transistor before it can be used.

In many instances the transistors have been available while their data sheets were, for some reason or another, not to be had for any price. This usually happens if the manufacturer decides to discontinue the transistor type and it becomes obsolete. These transistors can still be used by applying the method described here to determine the lead connection and transistor type. This will provide the starting point for measuring the other transistor characteristics should they be required.

The following information may be obtained:

1. The base lead

2. Polarity (p-n-p or n-p-n)
3. The emitter and collector leads
4. Type (point contact or junction)

The procedure listed here requires 10 simple resistance measurements made using an ohmmeter similar to the Simpson model 260 VOM (20,000 ohms-per-volt). See Fig. 106. Any given pair of leads of the transistor will show diode action; the resistance measured with the ohmmeter connected one way will be much lower than with the leads reversed. The low resistance is called the forward resistance, the high the back or reverse-bias resistance. The re-

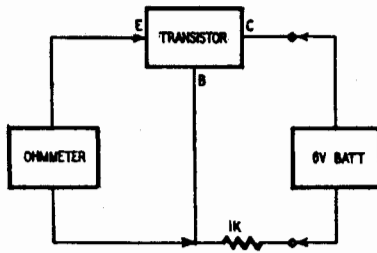

Fig. 106. Simple technique for determining the type of transistor.

sistance measurements should be made with an ohmmeter whose lead polarity is known. If the ohmmeter leads are not marked, they can be determined by using another voltmeter.

CAUTION: Do not permit a current larger than 1 ma to flow through the transistor. If the current delivered by the ohmmeter is not known, it should be checked with a milliammeter. Some ohmmeters use currents as high as 100 ma. The Simpson model 260 is satisfactory if only the two highest resistance ranges are used.

1. The first lead determined is the base lead of the transistor, found by measuring the three forward resistances of the transistor from lead to lead. The highest *forward* resistance is that between the emitter and collector. Therefore, the unused lead is the base lead of the transistor.

2. The transistor may now be classified as to polarity, p-n-p or n-p-n. With the negative lead of the ohmmeter connected to the base, connect the positive terminal of the ohmmeter alternately to the other two transistor leads. If forward-resistance measurements are obtained, the transistor has a p-n-p polarity. Note that the real positive lead of an ohmmeter may be the nominal negative (common). Check the leads with a dc voltmeter.

3. The emitter and collector leads have been identified as a pair

and can now be individually identified. Connect the ohmmeter to them to read the forward resistance and note the position of the positive lead. If the polarity of the transistor is p-n-p, the positive lead will be at the emitter; if the transistor is an n-p-n type, the positive ohmmeter lead will be at the collector.

4. A point-contact transistor can easily be distinguished from a junction transistor by its negative emitter-base resistance. Connect the ohmmeter as shown in the diagram to measure the emitter-base forward resistance. (The positive lead is connected to the emitter for p-n-p polarity.) Momentarily connect the 6-volt battery so that it will give a reverse bias to the collector. The emitter-base forward resistance for a *junction* transistor will drop to about one-half its value when the reverse bias is connected to the collector. However, if the transistor is a point-contact type, the resistance indication will go past the zero point and indicate a negative resistance when this reverse bias is applied.

testing transistors

BECAUSE individual transistors vary tremendously in their initial characteristics, a transistor checker is far more important to transistor circuitry than tube testers are to vacuum-tube circuits.

A type number is given to a transistor when it falls within certain maximum and minimum values called a production spread. This spread, for practical reasons, is large. Production techniques for maintaining rigid, uniform characteristics have not been developed. Often, the better transistors—with high current gain—are selected from a production run and given one type number while the lower gain units are given another. High-gain transistors are thus picked and marked for sale at a higher price.

Data sheets for lower-price transistors usually give only an *average* value of current gain without specifying any minimum. This is a “pig in a poke” situation where the buyer cannot be very sure about the quality of what he is getting.

Of two similar transistors purchased “off the shelf” one may operate well into the megacycle region; yet, the other may be good to only a few kilocycles. The purchaser of transistors must recognize these facts and realize that they exist even in brand new units that have never been connected to a circuit. The experimenter will find it highly advisable to measure the gain of his transistors even before they are put into service. By doing this he can then reasonably judge the capabilities of the transistor and thus use it in circuits where it will perform most efficiently.

Adding to these initial unit-to-unit variations are the changes caused by the transistor’s electrical and physical environment, such

as excess humidity, careless overheating, and exceeded ratings. Wrong socket insertion, the surge of a charging capacitor, and excess supply voltage are just a few of the things that can cause harmful changes or permanent transistor damage.

It is a good idea to keep a record of a transistor especially when it is used in different circuits. An occasional gain check can reveal any transistor damage and isolate the cause.

Current gain

Current gain is the most useful single transistor measurement. This gain varies with the transistor's type of operation. For grounded-base operation, the current gain is termed *alpha* and is always less than 1 but approaches 1 for the junction transistor. Alpha is the ratio of collector current change to emitter current change for a fixed collector voltage. This is sometimes referred to as the short-circuit gain since it does not take impedance change into account. Manufacturers usually express the gain of their transistors in terms of alpha.

However there is another term that expresses current gain for grounded-emitter operation. This grounded-emitter gain is called *beta* and bears a simple mathematical relation to alpha. If you know one you can easily find the other.

While alpha is always a decimal fraction less than 1, beta is expressed in small numbers greater than 1. With the beta measurement it is possible to glance at the gain and quickly know just how much better one transistor is than another. Alpha is not always so obvious. For example, how much better is a transistor with an alpha of 0.98 than a transistor with a 0.94 alpha?

The meaning and relationship between alpha and beta can be seen by observing the electron flow in the grounded-emitter and grounded-base circuits. These two circuits are shown in Fig. 201.

Suppose, as in Fig. 201-a, a signal change of 1 ma is applied to the emitter and this produces a 0.95 ma change in collector current. Alpha then must have a value of 0.95 because it is the change of collector current divided by the change of emitter current. Since the current flowing into a point must equal the current flowing out, the base current change is 0.05 ma.

If the same transistor is connected as a grounded emitter, a 0.05-ma signal applied to the base will create a 0.95-ma collector change. The gain in this case is the change in collector current divided by the change in base current. This is the beta gain, and it has a

numerical value of 19 for this transistor (Fig. 201-b). It is this gain that the checker measures.

The arrows in Fig. 201 indicate electron flow to the connections of a p-n-p junction transistor. Delta (Δ) means "a small change of" and the numerical relation of alpha to beta is:

$$\beta = \frac{\alpha}{1-\alpha}$$

Circuit

We can check junction transistors with a "null balance" instrument that measures the current gain by comparing the transistor

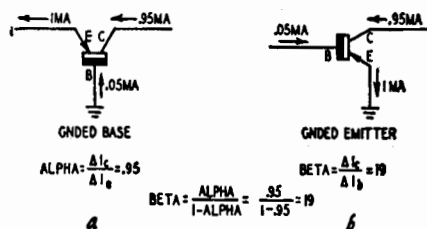

Fig. 201. Basic operation of the grounded base and grounded emitter circuits.

input and output signals (Fig. 202). The circuit is simple and its accuracy is limited mainly by the care with which the balance dial is calibrated and the accuracy of R1.

A 60-cycle signal is applied to the transistor base through R1, R4, R5, and C1. The emitter is grounded to point A, the neutral point for the checker. Capacitor C1 prevents the dc bias on the base of the transistor from flowing into the measuring circuits. The input signal is provided by a small stepdown transformer T1.

The signal to the base is called "constant current" because the high values of R4 and R5 almost completely determine the signal current flowing between the base and emitter terminals. The base-to-emitter resistance can vary from zero to several hundred ohms without appreciably affecting the transistor signal current.

Parts for transistor checker

Resistors: 3—100,000 ohms, $\frac{1}{2}$ watt; 1—5,000 ohms, 1% (precision); 1—1,000 ohms, potentiometer (linear).

Miscellaneous: 1—.02- μ f, 1—.05- μ f, 600

volts, capacitors; 1—stepdown transformer, 25,000 ohms c-t to 3-4 ohms; (Stancor A-3857); 1—push-button switch, normally open, s.p.s.t.; 1—4.5 volt battery; 1—power cord; 1 transistor socket; 1—chassis; terminals, terminal strips.

Signal current flowing in the emitter-base loop generates a small voltage across R1 directly proportional to the signal current. Thus

the current is indicated by the voltage generated across R1.

Since quantities are compared in a balance circuit, the absolute value of the signal current is not too important—the voltage from

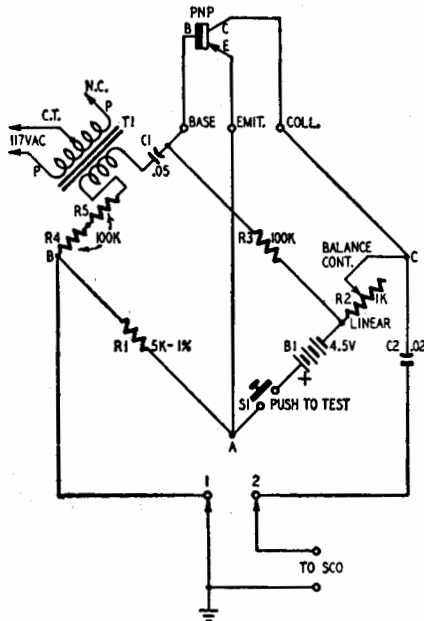

Fig. 202. The junction transistor checker is a "null balance" instrument.

T1 may vary without affecting the accuracy—but the accuracy of the comparison standard R1 is important. Resistor R1 must be a 1% precision unit.

A dc bias current, larger than the signal current, must be supplied to the base for class-A operation. The 4.5-volt collector battery supplies this current through R3.

The changing base input signal produces a larger collector-current output. This current flows through balance control R2, generating an output voltage proportional to the current. The voltage across R2 is opposite in phase to the voltage across R1. If they are equal in amplitude, they will cancel and no signal difference will exist between points B and C.

To measure transistor gain some null detector must be connected to the checker—an oscilloscope or audio amplifier will do—and R2 is adjusted until the 60-cycle output is zero or minimum. In this position the ratios of R1 and R2 are in the same proportion as the

transistor input and output signals. The gain then can be read from the calibrated balance control.

Construction

Almost any reasonable layout is suitable for the checker. The original unit used breadboard type construction on sheet bakelite

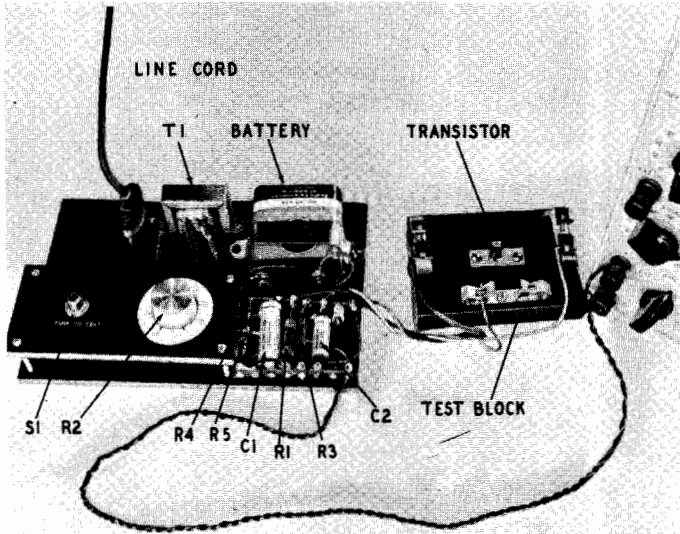

Fig. 203. The transistor checker uses a separate transistor mounting board. The battery is a 4.5-volt unit. It can be a single battery or 3 flashlight cells may be used. The code numbers given here correspond with those used in Fig. 202 on the facing page.

(see Fig. 203). However, this is not necessarily the best scheme of things. Bakelite is sometimes expensive and difficult to obtain.

The parts will fit under any 5 x 7 inch, or larger, chassis base. The terminals and balance-control dial could be mounted on top. This probably would be a good-looking and simple way to assemble the parts. To keep the cost of the transistor checker down most of the components consist of standard parts.

Several transistor test sockets mounted on bakelite can be used "outboard" and connected to the checker by three short lengths of hookup wire. Otherwise, it might probably be more convenient to mount the socket on the checker.

Since the socket is used frequently, it is advisable to use the hearing-aid 5-pin socket. This type is considerably more rugged than some of the currently available sockets. The two unused pins can be pushed out and the holes plugged.

Step-down transformer T1 is an output transformer with half of the primary connected across the 117-volt ac line and with the voice-coil winding providing the test voltage. The transformer used matches 25,000 ohms plate-to-plate center-tapped, to a 3-4 ohm voice coil. Any brand of transformer with similar specifications should be satisfactory.

Filament transformers can be used for T1 by changing the total value of R4 and R5. The sum of R4 and R5 should be 100,000 ohms for each volt of the filament transformer. Thus, a 2.5 volt transformer would require 250,000 ohms.

Two components, R1 and R2, must be chosen with care. Either a deposited-carbon or metal-film resistor is satisfactory. These resistors are nominally rated at 1%, but stock resistors can be used if they are carefully checked.

TABLE I—BETA AND BALANCE CONTROL RELATIONSHIP

Beta Value	R2 Setting (ohms)
5	1,000
6	833
7	714
8	622
9	555
10	500
11	455
12	417
13	385
14	357
15	333
16	313
17	294
18	287
19	263
20	250
25	200
30	167
35	143
40	125
50	100
60	83.3
70	71.4
100	50.0
Infinity	00.0

Ordinary replacement carbon controls should not be used for R2. However, molded composition potentiometers such as the Ohmite type "AB" are satisfactory. These controls cost more than twice as much as radio replacement units; but their superior characteristics make the additional cost worth while. Several mail-order houses stock this type control.

Most wire-wound controls can be used. Even the dollar-or-less

wire-wound controls are stable enough to be dial-calibrated for R2. The wire-wound laboratory potentiometers found on the surplus market are excellent for the checker.

Low checker impedances keep stray 60-cycle pickup problems to a minimum. The leads to the oscilloscope can be unshielded; and no shielding of any of the checker components is necessary. The ground terminal post from the oscilloscope is connected to terminal 1 and the input wire of the scope goes to terminal 2.

If the checker is built in a metal box or chassis, the chassis should be grounded to point A.

A television-type power connector is used to connect the 110-volt input. These TV connectors and cords make a very neat and inexpensive power-disconnect for experimental and commercial electronic equipment.

The collector battery can be any 4.5-volt battery. Three flashlight cells in series are also satisfactory.

Calibration

Beta markings on the balance dial correspond to specific resistance settings of R2. These values are given in Table 1. The maximum resistance of 1,000 ohms is equal to a beta reading of 5 since this resistance is $1/5$ of R1. Minimum resistance of course indicates infinite gain.

One way to calibrate the dial is to connect an ohmmeter and rotate R2 to each of the resistance values in the table. At each of these points mark the beta value on a dial made from some firm material that can be conveniently marked on.

If the control is sufficiently linear, the dial shown in Fig. 204 may be used. Most experimenters will find this dial sufficiently accurate for their particular purpose.

Use of checker

Connect the oscilloscope, the transistor socket, and the 117-volt ac plug. Set the oscilloscope's vertical gain to maximum.

The horizontal deflection may be turned off. This gives straight-line vertical deflection, in which case the balance knob is rotated for minimum deflection when the transistor is checked.

Alternately, the horizontal deflection may be turned on and the scope may be synchronized with the line frequency. This procedure permits observation of the signal waveform in the transistor circuits. If the scope does not have a 60-cycle position on the sync switch, set the sync selector to "external" and run a jumper from

the 60-cycle "test" terminal to the external sync terminal. Synchronizing the scope with the line, rather than the internal signal, makes the horizontal sync very stable and independent of both the phase and amplitude of the vertical deflection.

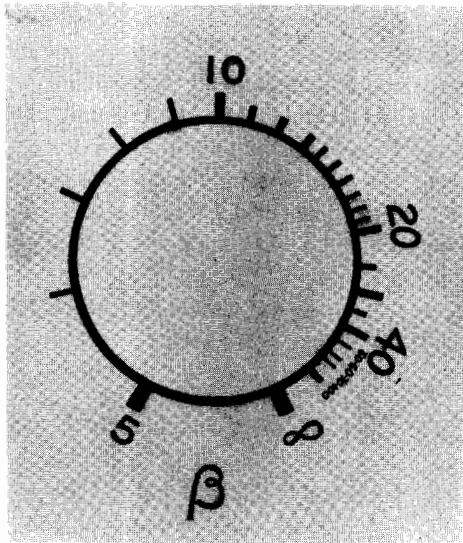

Fig. 204. *The calibrated balance-control dial.*

While S1 is open, the oscilloscope input floats and there is large 60-cycle pickup from strays (Fig. 205-a). With the transistor in place and S1 still open, the stray pickup will be clipped since the transistor functions as a simple rectifier.

When S1 is pushed, the scope display indicates how close to balance the checker is. The patterns either side of and at balance are shown in Figs. 205-b,-c,-d.

Because the signal from the checker is in the order of millivolts, the deflections with S1 closed will be small but large enough for use with even the lowest gain scopes. Do not expect large deflections.

If an oscilloscope is not available, the output from the checker can be fed into the microphone or variable-reluctance phono input of an audio amplifier. Rotate R2 until a minimum hum level is heard. Do not use an amplifier that does not have a transformer power supply.

To check n-p-n transistors, simply reverse the connections to the 4.5-volt battery. This is the only necessary change.

A total of 13 new transistors have been tested on the checker. The average beta should be 9 according to the data sheet. One transistor had a gain of 14, while three units measured gains dangerously close to 5. The remainder of the transistors had betas of about 7 or 8. Of course it is not implied that this was a representative

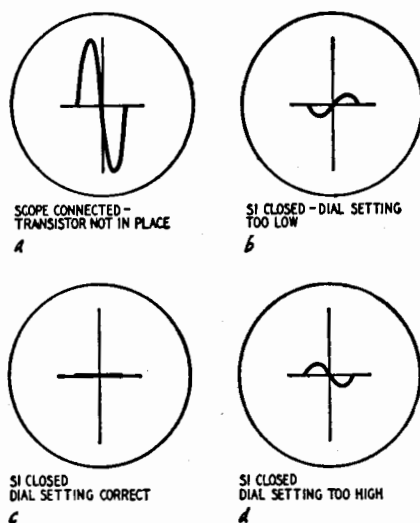

Fig. 205. Test patterns that will be obtained when the oscilloscope is connected to the "null balance" transistor checker.

group of transistors; but it does point up the earlier statement about variations that must be expected.

Testing transistors with an ohmmeter

Another technique (in addition to the one just described) that can be employed for testing transistors uses an ohmmeter. The conventional ohmmeter check measures the forward and back resistances between two of the transistor elements taken at a time, as if it were a double diode with a common base. Although this method reveals an open, short or other extreme kind of transistor failure, it furnishes no evidence that the transistor may be unsatisfactory when operating as a triode. For example, in testing whether a transistor had been damaged by soldering heat, the conventional diode-check method might easily pass the transistor because it may show a much higher back than forward resistance. Actually, it can be very poor in triode performance. Thus, it is important to be able

to get some indication of triode action, if only a rough one. This test unit provides just such an indication. It registers a substantial change in meter reading, indicating a large change in output collector current resulting from a small change applied to the input base circuit of the transistor under test. In short, even though it is a simple check, it adds the highly desirable feature of checking the transistor as a triode.

Aside from the newness of the transistor art the main obstacle to a simple and straightforward test is the fact that the transistor is highly sensitive to the choice of its dc operating point. Even if we ignore the various other factors that transistor operation depends upon—temperature, impedance matching and the like—widely different results for current amplification are likely to be obtained for slightly different operating points. For a power transistor, for example, the operating point may be very different than for a general-purpose unit.

Despite these difficulties, it is still feasible to cut through many test qualifications by keeping firmly in mind that our object at the moment is to check a transistor's condition, and not make a comprehensive test of transistor characteristics. For our purposes, we can concentrate on the following two questions:

Is the test safe and simple enough to be practical?

Do the results reveal a defective transistor?

As to being practical, the test unit (see Fig. 206) requires only a few fixed resistors, a toggle switch and a terminal strip for mounting. When used with the proper multimeter scale, both meter and transistor are protected from damage by the current-limiting provisions built into the multirange meter. Used under these conditions, the largest voltage that can be applied to the transistor is 1.5 (or, for some meters, up to 4.5 volts) and there is no necessity for switching ranges. The entire operation is no more complicated than taking two ohmmeter readings.

As to its ability to detect a faulty transistor, the test unit not only detects the more obvious resistance defects that would show up in a diode resistance check but also reveals faulty triode action by indicating relative current changes resulting from the amplifying ability of the transistor. Keep in mind that these readings are not intended for comparing the merits of different makes or configurations of transistors, but rather as a practical means of comparing the action of a questionable transistor with that of a good one of the same type.

Transistor check circuit

The test unit (Fig. 207) operates with the transistor in a ground-emitter hookup. This circuitry provides one of the most significant clues to the condition of a transistor—its ability to amplify small changes in its base current. To do this, the test takes advantage of the circuitry in conventional service type multimeters on

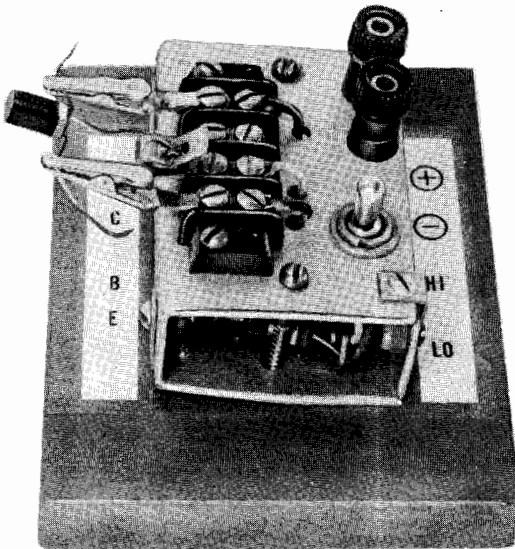

Fig. 206. *The transistor test unit. The connection points are easily identified.*

their resistance ranges (shown in dashed lines). This section already contains a 1.5-volt cell for the voltage supply, a sensitive meter and a series limiting resistor R_s which protects both the meter and the transistor under test. Using these, the test circuit boils down to providing a means of indicating changes in current as the transistor is checked.

The first meter reading is taken with the spdt toggle switch in its LO position, corresponding to zero base current bias. The toggle switch is then thrown to HI. This sends a small dc bias current through the base of the transistor, causing a much larger current to flow in the collector circuit. The increase in meter reading indicates the relative current-amplifying ability of the transistor under dc conditions. The difference between the high and low reading is then compared with the meter-swing increase caused by a good

transistor of the same type. This provides a check on the condition of the transistor.

No attempt is made to measure ac signal performance since this is more properly a manufacturing measurement. It is more the function of a transistor check to detect those signs that point to possible deterioration or failure. Passing over the more obvious defects—

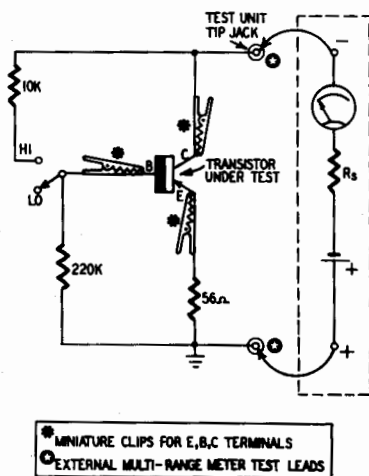

Fig. 207. Setup for transistor check.

opens or shorts—that show up immediately, there remain two major indications of possible deterioration: (1) a marked increase in the relative I_c , the amount of collector current that flows at zero base current, indicated by the meter reading in the LO position; (2) a substantial decline in the transistor's current-amplifying ability, the difference between the HI and LO meter readings.

Transistor check procedures

Since the transistor, like other semi-conductors, is a nonlinear device, its effective resistance may vary widely, depending on the voltage across it. Thus, different ohmmeters, or more important, different ranges of the same ohmmeter, will result in noncomparable readings. This need not present any serious difficulties as long as only one ohmmeter and one resistance range of that meter is used, but it is well to understand the limitations. The meter used here is a Precision model 120. On its X100 resistance range it uses a 1.5-volt cell and has a center scale of 2,000 ohms. Any ohmmeter, using not more than 4.5 volts and having a center-scale reading of between

1,000 and 3,000 ohms is also suitable, with the proper allowance made for expected readings as compared with those of a good transistor.

The polarities shown in the circuit diagram are for p-n-p transistors. *The positive polarity does not necessarily coincide with the red lead of any particular ohmmeter.* In the Precision 120, as in

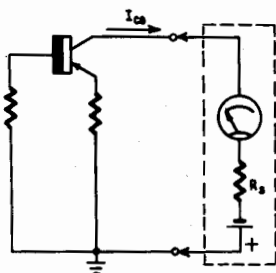

Fig. 208. Check circuit in LO position.

many others, the red lead is connected to the negative terminal of the ohmmeter battery. It is a simple matter to check this polarity on a voltmeter. It can even be checked on a diode, known to be good, by observing which polarity gives the conventional easy current flow for forward resistance.

For the p-n-p transistor check, a negative polarity is applied to the collector. With the switch at LO there is zero base current and the meter indicates the so-called saturation current (I_c) flowing in the collector circuit (Fig. 208). When the switch is thrown to HI (Fig. 209), the base is connected to a sufficiently negative point on the voltage divider (R_1 and R_2) so that a small bias current (about $50 \mu\text{a}$) flows through the base circuit. This results in a greatly increased collector current for the second reading. The difference in the two readings indicates the approximate relative effectiveness of the transistor for current amplification.

Strictly speaking, the second reading is made up of more than just the collector current; it is the sum of the collector current and the currents flowing in the base and the voltage-divider circuits. The situation does not introduce any serious inaccuracies, since, in the case of a typical transistor, the amounts of base current (around $50 \mu\text{a}$) and bleeder current (around $6 \mu\text{a}$) together form only a small part of the total reading (around $500 \mu\text{a}$). Thus, the HI reading is made up of collector current for the most part (around 90%) and, therefore, a large difference between the HI and LO readings gives a sufficiently valid indication of the current-amplifying

ability of a transistor. The emitter resistor provides stabilization for the dc operating point used.

There is an incidental benefit derived from using the ohmmeter connection as shown. If an n-p-n transistor is to be tested, reverse the ohmmeter leads. The simple flipover automatically insures that the bias and collector circuits are connected to their proper polar-

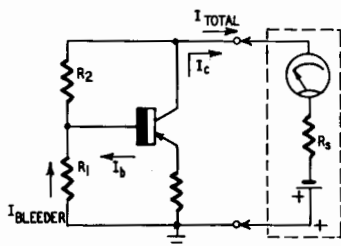

Fig. 209. Check circuit in HI position.

ities for the n-p-n transistor. The meter will still read in the forward direction and readings will be equally valid for this type of transistor.

Table 2 gives a summary of results obtained with good transistors (and two defective ones, as noted), using the test unit connected to a Precision 120 meter. In all, more than 30 transistors were tried, divided by types into three groups.

After the first column of the table, identifying the transistor group, typical meter readings are given in the next two columns for the LO and HI positions of the test switch. The difference between these two gives the *net change*, a measure of *relative sensitivity*.

If some other meter is used, the results of the table can easily be adapted, provided the meter's X100 resistance scale is reasonably sensitive. The internal battery of the meter on this range should be between 1.5 and 4.5 volts and the center scale for the same range should read between 1,000 and 3,000 ohms.

The following example relates the table's meter readings to another meter having a center scale of 1,000 ohms and a 3-volt internal battery on its X100 resistance range: The full-scale sensitivity of such a meter on this range can be calculated to be 3 volts divided by the center-scale reading of 1,000 ohms, giving a full-scale deflection (with the test leads shorted) of 3,000 μ a or 3 ma. This compares with 1.5 volts divided by 2,000 ohms or 750 μ a for the Precision 120

used in the table. Thus, the substitute meter has a sensitivity of only one-fourth that of the meter used and it can therefore be expected that the readings obtained for the average transistor will be approximately one-fourth that of the readings shown in the table.

TABLE 2—SUMMARY OF CHECK RESULTS

<i>Average meter readings—good transistors</i>			
Transistor Group	Lo	Hi	Net Change
	Based on scale of 60		
General Purpose	6	40	34
Rf	3	38	24-40*
Af	5	43	35
			34-37*
			38
			37-39*
<i>Average meter readings—bad transistors</i>			
General Purpose			
Sample 1†	6	18	12
Sample 2‡	1	7	6
<p>* Range of individual net change in this group. † Had been exposed to excessive soldering heat. Still showed satisfactory back-to-forward resistance. ‡ Excessively high resistance in both forward and reverse directions. NOTE: For a workable minimum, a transistor should give a net change of at least 50% of the net-change figure to be considered good.</p>			
<i>Transistors Used in Above Checks</i>			
<i>(p-n-p unless otherwise noted)</i>			
General Purpose	Rf	Af	
Amperex 0C71	HydroAire HF1	Amperex 0C72	
Germanium Products (n-p-n) 2N103, 2N99	Raytheon CK760	G-E 2N44	
HydroAire CQ1	Texas Instruments (n-p-n) 223-536	Transitron 2N44, 2N85	
Raytheon CK722			
Transitron 2N34, 2N35, 2N65			

The more sensitive meter will discriminate more between good and bad transistors, but there is sufficient latitude in the check method to spot a poor transistor even with the less sensitive one. As a corollary, if the constructor wishes to build an independent transistor checker with a battery and milliammeter, he will be well advised to use a meter having 1-ma full-scale deflection, for convenience in calculations.

Before checking a transistor as a triode, check each B to E and B to C diode of the transistor for forward and back resistance. This eliminates transistors having obvious defects involving short, open or erratic (intermittent) readings.

Parts for transistor checker

1—56, 1—10,000, 1—220,000 ohms, 1/2-watt resistors; 1 terminal strip, double-screw

type, three terminals; 3—alligator clips (solder to soldering lug for mounting on terminal strip), midget type; 1—chassis; 1—spdt switch; 2—tip jacks.

Because of the rugged construction and the long operating life of transistors in general, be cautious about blaming the transistor for poor circuit operation. This is a vastly different approach from the method we have been accustomed to in tube circuits, where the tube turns out to be the culprit perhaps 90% of the time. In normal use, a transistor does not damage or deteriorate easily although it does not take much to damage a transistor through excessive voltages or excessive heat. Even polarity reversals need not harm the transistor as long as the maximum voltage and current ratings are not exceeded.

transistor performance

TEST methods and specifications are necessary for the proper evaluation of transistors because they are temperature-sensitive devices whose characteristics and parameters vary over wide ranges. Consequently, the operating point of a transistor will vary unless it is "stabilized."

Vacuum tubes operate with constant plate and grid voltages, while transistors operate with constant collector voltage and con-

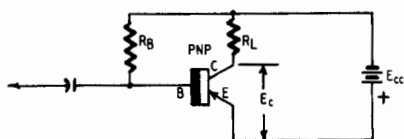

Fig. 301. *This transistor circuit operates on fixed bias.*

stant base current. And, like a tube, a transistor operates along a load line. The slope of the collector load is $1/R_L$. The operating point of a transistor can be established either with fixed or self bias. For fixed bias (fixed base-current bias) operation, resistor R_B is connected between the supply voltage and base electrode. (Fig. 301). This resistor should be large enough so it will supply a *constant* current to the base.

When the operating point is determined by self bias, resistor R_B is connected between collector and base electrodes (Fig. 302). The base biasing current is determined by Ohm's law. That is, base current I_b is determined by collector operating voltage E_c .

and R_s . If E_c is 10 volts and R_s is 400,000 ohms, the base current is $I_b = E_c/R_s = 10/400,000 = 25$ microamperes.

The collector load line (dc load line) is determined by the values of collector supply voltage E_{cc} and R_L (Fig. 303). The bias line is included since the base current is known (from the Ohm's law example) for various values of E_c and R_s . The dc operating point is given by the intersection of the biasing and collector load lines.

Since transistor characteristics vary with temperature, a shift in the I_c - E_c curves occurs; that is, the spacing between curves changes with temperature. We know that transistor parameters such as current gain and output impedance vary with temperature (also, tran-

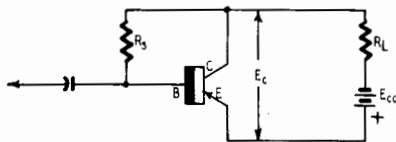

Fig. 302. Circuit for self-bias operation.

sistor parameters vary because of small changes in physical conditions occurring during the manufacturing process). This means that the transistor operating point shifts when the spacing between I_c - E_c curves changes.

All of these deviations contribute to variations in collector current and voltage from unit to unit of a given transistor type. This can lead to a serious situation unless design practices are good. For example, suppose that a defective collector load resistor decreases in value. If this happens, the collector current can increase beyond the rated value. The excessive dissipation would ruin a transistor (even though the collector voltage is well within safe limits). Similar damage could occur if the leakage currents (I_{co} or I_{cbo}) increased beyond safe limits because a customer left his transistor radio in the hot sun at the beach (and this most certainly will happen!).

Stabilizing the transistor

Consequently, adequate methods for *stabilizing* the operating point must be used if transistors are to be regarded as reliable electronic devices. Fortunately, several methods of stabilization are available, and are simple to apply.

Stabilization is obtainable in several ways: with current feed-

back, combinations of current feedback and fixed bias or current and voltage feedback. Combination current and voltage feedback is shown in Fig 304. Current feedback is obtained from emitter resistor R3 and resistor R2 connected between base and ground.

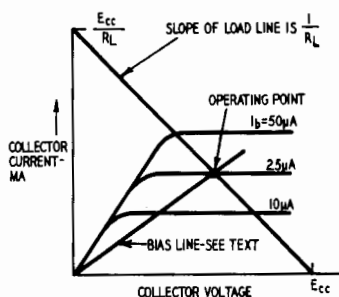

Fig. 303. Typical collector load line. The slope of the load line is inversely proportioned to R_L .

Resistor R2 provides reverse base bias; R1, between collector and base electrodes, supplies voltage feedback. Self-biasing resistor R1 (like R_s in Fig 302) supplies forward base bias to establish the operating point.

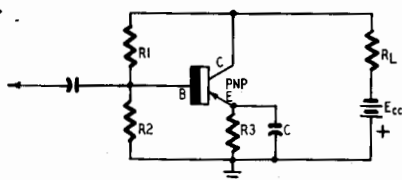

Fig. 304. Stabilization is obtained by using a combination of current and voltage feedback.

R. F. Shea¹ has established a mathematical criterion for stabilization of transistor amplifiers. Fig. 305 shows an R-C-coupled amplifier. It will be stabilized if:

$$S_f = \frac{\Delta I_c}{\Delta I_{co}} = \frac{1 + \frac{R_3}{R_1} + \frac{R_3}{R_2}}{\frac{1}{1 + \beta} + \frac{R_3}{R_1} + \frac{R_3}{R_2}}$$

where β is the current gain of a grounded-emitter stage; S_f is an expression of the ratio of changes in collector current ΔI_c and leakage current ΔI_{co} . The numerical value of S_f should be small (in gen-

¹R. F. Shea, *Principles of Transistor Circuits*, p. 103, Wiley & Sons, 1953.

eral values from about 1 to 7 give satisfactory stabilization). Additional stability is obtained by *derating* the transistor (collector current and voltage reduced below rated values) and reducing the I^2R losses in the stabilizing resistors.

To look at stabilization from a practical viewpoint, consider the following circuit: Fig. 306 shows a *stabilized* amplifier using her-

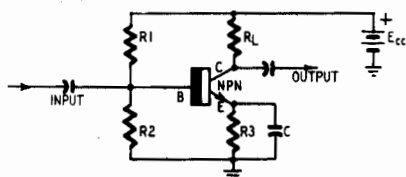

Fig. 305. Circuit for determining the stabilization of transistor amplifiers.

metically sealed silicon junction transistors. In the first stage resistors R3 and R2 provide current feedback, while the *parallel resistance* of R1 and R2 controls the amount of stabilization. The *ratio* of R1 and R2 determines the operating bias.

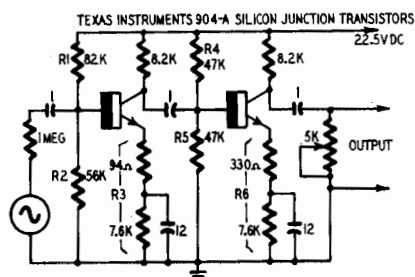

Fig. 306. Stabilized transistor amplifier.

A similar situation exists for the second stage: R6 and R5 supply current feedback, the parallel value of R4 and R5 controls the amount of stabilization, the ratio of R4 and R5 determines the bias. Also, the S_T factor is small, and the supply voltage has been derated 25%.

The performance of this amplifier is better than many vacuum-tube amplifiers in several respects. The frequency response of a stabilized silicon junction amplifier, for two different ambient temperature conditions, is shown in Fig. 307. Fig. 308 shows an unstabilized amplifier for comparison with the stabilized unit. It is an R-C-coupled amplifier operating with fixed bias, with some degeneration present because of the resistors in the emitter circuits.

The performance of this amplifier is unsatisfactory and unpredictable since it is unstabilized.

It is interesting to note that hermetically sealed type 904-A silicon junction transistors (Texas Instruments) show an increase in gain

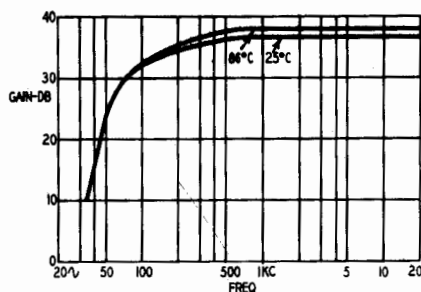

Fig. 307. Response of stabilized amplifier using silicon junction transistors.

at higher temperatures (even when a high percentage of humidity is present) as shown in Fig. 307.

Low-frequency transistor circuits

The low-frequency response of an R-C-coupled amplifier depends on the values of coupling capacitor, coupling resistors and the load resistor (Fig. 309). The coupling resistors reduce current amplification at lower frequencies because the input (base) resistance of most junction transistors (stage two) is small. Also, the imped-

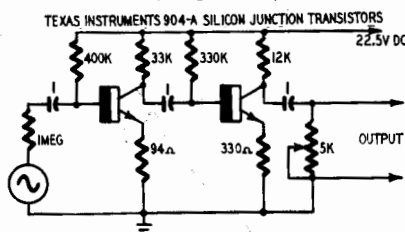

Fig. 308. Unstabilized amplifier circuit.

ance of the coupling capacitor is much greater than the input resistance of this stage at lower frequencies. For a bird's-eye view of this, assume coupling resistor R_1 equals load resistor R_L . The frequency at which the response is 3 db down from the mid-frequency value is given by:

$$f = \frac{1 (R_1 + R_L)}{(2\pi C) (R_1 + R_L)}$$

If C is $1\ \mu\text{f}$ and $R_1 = R_L = 10,000$ ohms, the response is down 3 db at approximately 33 cycles.

Low-frequency transistor circuits are reliable and practical. In designing low-frequency amplifiers, it is convenient to have available some general "rules of thumb" to use as a check. The *conductance* (and current gain) of the first stage should be large; this requires the use of a *grounded-emitter* stage. Sometimes a *grounded*

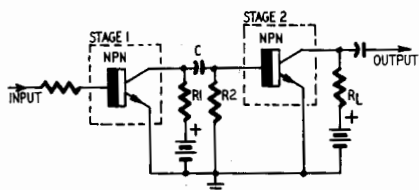

Fig. 309. Resistance-capacitance coupled amplifier stage.

collector (emitter follower, analogous to a cathode follower) is used as the first stage, especially if the generator (source) impedance is large. The grounded emitter is usually used for intermediate stages because the current amplification should be as large as possible.

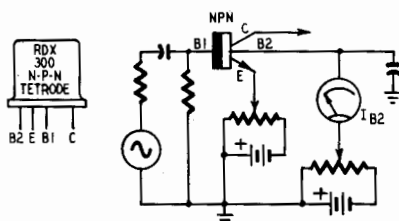

Fig. 310. Tetrode using base 1 input.

The final stages require the use of power transistors or stages designed for *maximum power gain*. Single-ended or push-pull grounded-emitter power stages are used here. Sometimes the *grounded-base* configuration is used if the load impedance is large. Low-powered, hermetically sealed, germanium transistors suitable for this are the 2N34, 2N43A and 2N38. Suitable silicon transistors are the hermetically sealed 900 series of Texas Instruments. A satisfactory hermetically sealed germanium power transistor is the Minneapolis-Honeywell 2N57. A satisfactory hermetically sealed silicon power unit is the Texas Instrument type X-15.

The high-frequency response of transistor circuits is complex—it depends on solid-state parameters, collector-junction capacitance (area), phase shift and other variables. Consequently, high-

frequency circuits are difficult to design and give less reliable performance. The high-frequency response of a transistor is described on most data sheets by the phrases "alpha cutoff frequency" or "beta cutoff frequency." This language refers to a condition when the high frequency response is 3 db down from the mid-frequency

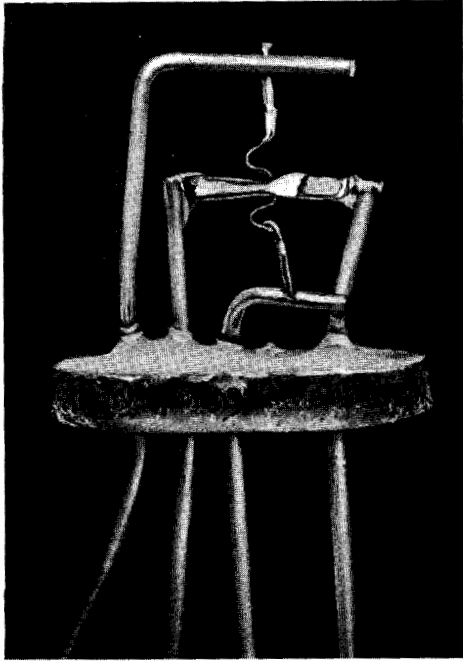

Fig. 311. Internal construction of the RDX-300-A (3N23-C) germanium tetrode transistor. The addition of the fourth electrode, combined with proper biasing, effects a considerable reduction in the base resistance of the transistor. Lowering the base resistance increases the frequency range at which the transistor will operate.

value. For conventional low-powered junction transistors this point is somewhere between 1 and 9 mc.

The tetrode transistor

One of the most promising devices for obtaining improved high-frequency operation is the tetrode transistor. The RDX-300-A (3N23-C) germanium tetrode, made commercially by Germanium Products Corp., Jersey City, N. J., is a hermetically sealed, n-p-n, grown-junction transistor with four electrodes. A tetrode has an emitter electrode, a collector electrode and two base electrodes.

The emitter and collector are n type material. Bases 1 and 2 (Fig. 310) are connected to opposite sides of a thin p type layer of germanium. The internal design of this tetrode is shown in the photograph, Fig. 311.

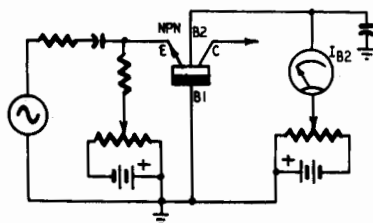

Fig. 312. *Tetrode using emitter input.*

There are several reasons for the improved high-frequency response of the n-p-n tetrode. This type of design decreases the area of the collector junction, the use of thin layers of p type mate-

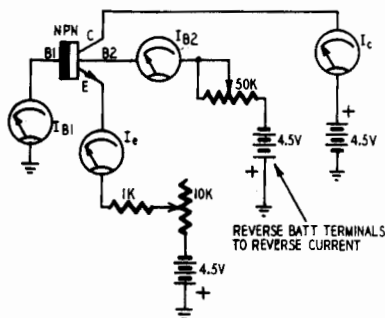

Fig. 313. *Circuit used for measuring tetrode transistor dc characteristics.*

rial increases the high-frequency range, reduction of the base resistance improves the high-frequency response.

In general, the operation of the tetrode transistor is as follows. Base 2 usually is used as the biasing electrode. Base 1 can be used in two ways. It can be the input electrode for grounded-emitter operation (Fig. 310). Or, if emitter input is used, base 1 is grounded (Fig. 312). When a satisfactory bias is applied to base 2, it confines the current flow to the neighborhood of base 1. This action reduces the intrinsic base resistance by an appreciable amount, increasing the upper-frequency response of the tetrode. Fundamentally, a tetrode is a "twin-based triode."

Selected RDX-300-A tetrodes have been used as sine-wave oscillators at frequencies near 100 mc. Also, they have been used as

tuned amplifiers at frequencies near 50 mc. No doubt tetrodes will be used in future television sets as if amplifiers.

The dc leakage currents I_{co1} and I_{co2} (emitter open and leakage measured from collector to base 1 and then from collector to base 2) of a tetrode must be less than $10 \mu\text{a}$ each, at room temperature, with 4.5 volts on the collector. In I_{cbo} leakage current (current between collector and emitter with bases open-circuited) should be less than $150 \mu\text{a}$ with 4.5 volts on the collector. These leakage currents are uncomfortably high in presently available tetrodes.

A circuit for the measurement of the dc characteristics of tetrodes

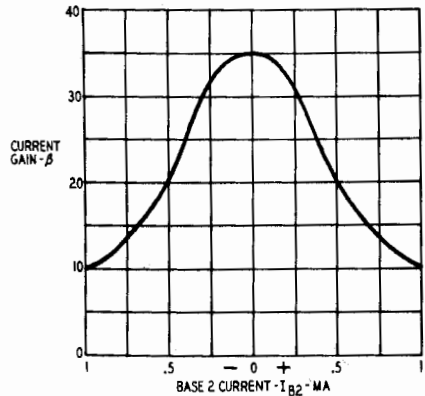

Fig. 314. Beta (current gain) vs. base 2 current.

is shown in Fig. 313. Although this circuit can be used to obtain the usual collector current *vs.* voltage characteristics, it can also be used to obtain other valuable data such as collector current *vs.* base 2 bias current (for a constant emitter current—1 ma—and collector voltage, 4.5). Such characteristics are similar in shape to series resonance curves (when circuit resistance is large) or somewhat similar in shape to the curve in Fig. 314.

The small-signal current gain β of a tetrode may be obtained with the circuit of Fig. 315. In this case the tetrode is operated with E_c at 4.5 volts, I_e is set at -2 ma and an input frequency of 1 kc is used. Beta is read directly from the vtvm and is derived as follows:

$$\beta = \frac{di_c}{di_b} = \frac{\frac{E2}{10^2}}{\frac{E1}{10^4}} = \frac{(10^4) (E2)}{(10^2) (E1)} = (10^4) (E2) = 10,000 E2$$

since E1 was set at unity. For example, if the vtvm reads .004 volt, beta is 40.

Tetrode bandpass amplifier

The low values of output capacitance and resistance of a grounded-base stage suggest the possibility of building reasonably

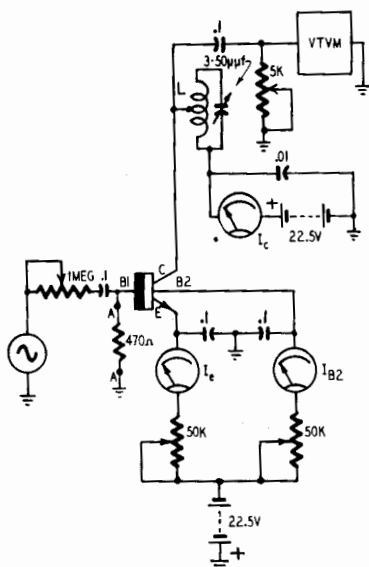

Fig. 316. Circuit of experimental tuned high-frequency tetrode amplifier.

wide bandpass amplifiers without much sacrifice in gain. To illustrate this, the circuit shown in Fig. 317 was designed to pass a 9-mc

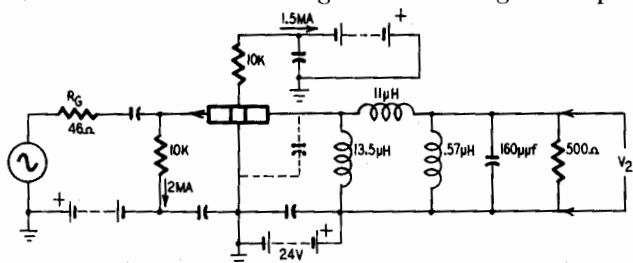

Fig. 317. Tetrode transistor amplifier with 9-mc bandpass.

band of frequencies centered around 32 mc. The measured response curve is shown in Fig. 318, from which it can be seen that the gain is 15 db. The other response curves shown in Fig. 318 were measured with a coupling network similar to that shown in Fig. 317, but deliberately designed for smaller bandwidths at lower frequencies.

Tetrode sine-wave oscillator

The circuit of Fig. 319 has been used to observe the performance of tetrode transistors as oscillators at high frequencies. It resembles a conventional Hartley circuit, with the exception that provision is made for adjusting the value of the capacitance in the feedback path to the emitter.

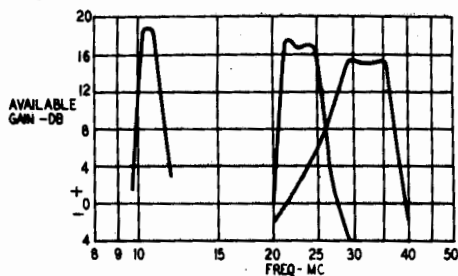

Fig. 318. Response of amplifier in Fig. 317.

At the higher frequencies the input impedance at the emitter tends to become inductive, and it is necessary to adjust this capacitor. Used in this circuit, most of the tetrodes which have been

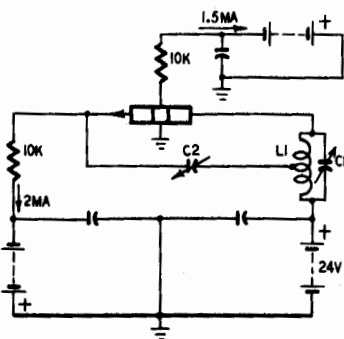

Fig. 319. Tetrode sine-wave oscillator.

made will produce sinusoidal oscillations up to frequencies as high as 80 to 100 mc. Four or five have been capable of oscillating at frequencies above 100 mc and two will oscillate at 130 mc.

Power output of this oscillator has been measured as a function of frequency for one transistor. Between 40 and 75 mc the measured output was approximately 1 mw. At 100 mc the output is 0.25 mw and at 115 mc, 0.06 mw. The collector dissipation was held to about 30 mw during these measurements.

transistor measurements

TRANSISTORS are current amplifiers. Their greatest limitation is that they are *temperature-sensitive*. That is, their characteristics vary with temperature. Important transistor characteristics are described by the symbols: I_{co} , I_{cbo} , β and R_{out} . I_{co} , I_{cbo} are leakage currents; β is current gain. R_{out} is the output impedance of a common (grounded) emitter transistor.

Test methods

Test methods for these parameters are important because these measurements are the most economical way to identify satisfactory transistors. Usually there is no need to measure other parameters. For instance, base resistance r_b and emitter resistance r_e are relatively unimportant in general service work (unless either is open- or short-circuited, in which case replacement is obviously required) and need no further discussion. The general specifications for good transistors are that r_b shall be less than 1,000 ohms and r_e less than 50 ohms, at room temperature, when emitter current is 1 ma and collector voltage is 6.

To simplify measurement use the common (grounded) emitter connection and divide transistors into two groups according to the kind of semiconductor used: germanium and silicon junction transistors. Tests for point-contact transistors are omitted because these units have negligible commercial value. Engineers in industry feel that junction transistors eventually will replace point-contact units in most applications.

Measuring I_{co} and I_{cbo}

Fig. 401 shows I_{co} , the dc leakage between collector and base when the emitter is open-circuited. I_{co} increases with temperature, and should be smaller than I_{cbo} —the smaller it is, the “cleaner” the transistor. Clean transistors have longer life because they are relatively free of contaminating materials.

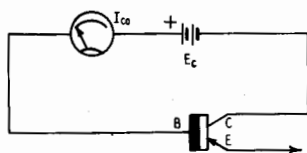

Fig. 401. Measuring dc leakage current between collector and base. Emitter is open circuited.

Fig. 402 shows I_{cbo} , the dc leakage between collector and emitter when the base is open-circuited. I_{cbo} increases with temperature. It is a measure of collector efficiency—the smaller it is, the higher the efficiency.

Both I_{co} and I_{cbo} increase with age. The tests in Figs. 401 and 402 are the first step in determining whether a transistor can still be used or if replacement is necessary. If I_{co} and I_{cbo} are erratic, or larger than specified, the transistor should not be used.

Current gain in common-emitter transistors is described in three ways. By current gain (dc), $\beta = I_c/I_b$; by incremental current gain (dc), $b = \Delta I_c/\Delta I_b$; and small signal current gain, beta or $\beta = di_c/di_b$. The ratio I_c/I_b is often used to describe current gain (dc) in power transistors. It is substituted for ac measurements when the huge current passed through some high-power units exceeds the rating of available radio components. Incremental current gain b is the ratio of incremental changes in collector and base dc (for constant collector voltage V_c). Small-signal (ac) current gain β is the gain from collector to base with the output short-circuited (for constant E_c). The latter two items describe gain for medium- and low-powered transistors.

R_{out} is the output impedance of a common-emitter transistor. It should be large because it decreases with increasing temperature.

Germanium junction transistors

Early plastic-encapsulated transistors were unreliable. Moisture and impurities, trapped during the encapsulation process, “poisoned” the germanium *heart* of the transistor. This slow

killing process caused unstable operation and failure. Several important facts were learned during the evaluation of plastic-coated transistors. First, transistors must be assembled under surgically clean conditions. Second, rigorous factory tests were necessary if quality and performance were to be maintained. Third, the units had to be enclosed in hermetically sealed containers. For example, transistors encapsulated in plastic had relatively large I_{co} and I_{cbo} readings. When the same units were assembled under surgical

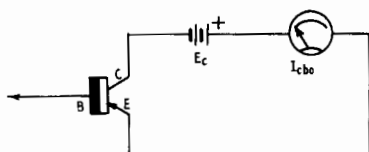

Fig. 402. Measuring dc leakage current between collector and emitter. Base is open circuited.

conditions and mounted in hermetically sealed cases, these current readings dropped appreciably.

The I_{co} reading (Fig. 401) for most hermetically sealed, small-signal transistors should be less than $18 \mu\text{amp}$ at room temperature, with -22.5 volts between collector and base. The manufacturer of 2N43 and 2N43A p-n-p transistors specifies that I_{co} shall be less than $10 \mu\text{amp}$ at room temperature, with -45 volts between collector and base. This should become an industry-wide standard.

The I_{cbo} reading (Fig. 402) for most hermetically sealed, small-signal transistors should be less than $125 \mu\text{amp}$ at room temperature, with -6 volts between collector and emitter.

Both I_{cbo} and I_{co} increase when a warm soldering iron is held near a transistor or even if the unit is held in the fingers while making measurements. This is another way of emphasizing that current increases with temperature. It is illustrated in graphs of I_{co} versus temperature on data sheets that accompany most transistors. If current increases slightly with temperature, there is no cause for alarm unless the current is unsteady. This often means defective junctions.

To investigate this further use the circuit in Fig. 403, with an oscilloscope in the dc position and a slow sweep (approximately 200 to 500 μsec per centimeter). Two switches (S1, S2) are used so you can see both the collector-to-base and emitter-to-base patterns on the scope. When either switch is flipped off-on-off, the dc voltage across the resistor deflects the scope beam. Set S3 and the scope

gain so the pattern jumps about 1 inch. Good transistors generate patterns that are well-defined step functions (a). If the pattern has poor rise (b) or fall time (c) or is unstable or shows appreciable noise (d), the transistor has a faulty junction.

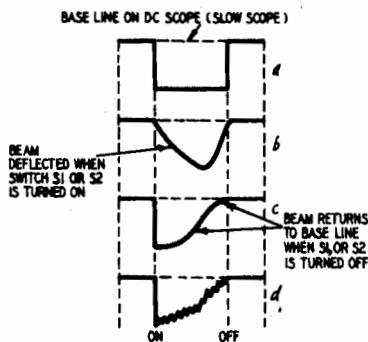
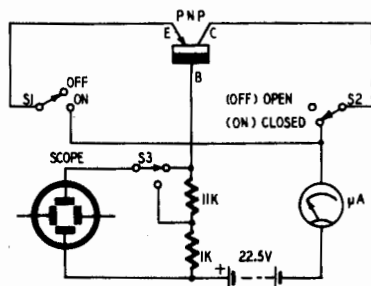

Fig. 403. Circuit tests *p-n-p* junctions. Scope is in dc position with slow sweep.

Transistor noise

Let's clarify the confusion that exists about transistor noise. The confusion began only because the point-contact unit appeared on the market before the junction type. Point-contact transistors have poor noise properties—a great disadvantage. Junction transistors have excellent noise properties. Noise in many junction transistors measures only 3 or 4 db above theoretical (Johnson) noise. Compare this with about 8 db of noise from the 1620 vacuum tube—the best tube as far as noise is concerned. But tube noise increases when the electrodes are subjected to vibration or shock. In junction transistors, noise is related to the ratio of the sizes of collector

and emitter junctions. Hence, noise for a given transistor is fixed and does not change appreciably with vibration or shock. Nominally, noise in good junction transistors is from about 10 to 20 db.

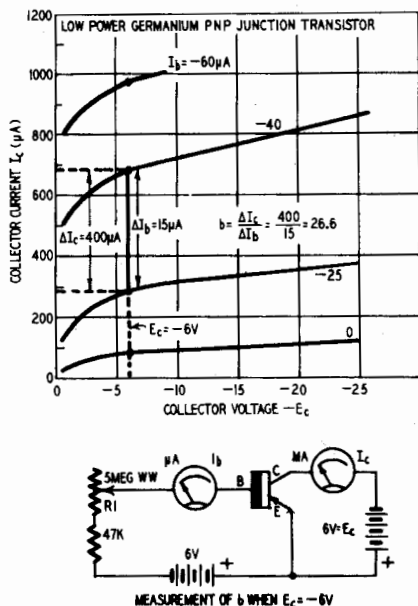

Fig. 404. Drawing at the top shows transistor static characteristics. The circuit diagram below it illustrates a method of measuring incremental current (dc) gain b .

Duality

The duality concept is useful when comparing transistors and vacuum tubes. Base current bias is the dual of grid voltage bias; collector current the dual of plate voltage and collector voltage replaces plate current. In other words, current and voltage functions are interchanged when comparing static characteristics of transistors and tubes.

Fig. 404 shows part of a set of transistor static characteristics. The diagram shows how to measure incremental dc current gain. R1 adjusts base bias current from about 1 to 130 μ amp. With E_c at -6 volts, adjust R1 so that I_c is about 0.3 ma. Note the values of I_c and I_b . Then change R1 slightly and note the new readings in I_c and I_b . Differences in readings are the incremental changes ΔI_c and ΔI_b . Values of b vary widely for various transistors of a given type. For this test, practical working limits for b are from about 18 to

140. If b is less than 18, insufficient gain will be obtained. If it is greater than 140, the transistor probably is unstable.

The small-signal current gain β in low-powered transistors is the dual of μ in a triode vacuum tube. A circuit for the measurement of β is shown in Fig. 405. The choke should be a UTC HQB-6 or equivalent, and the capacitors pyranol or equivalent non-polarized. The beta factor is defined as collector-to-base current gain with the output short-circuited. Adjust R1 so that I_c is 1 ma. Set E1 to 1 volt at 1 kc. Resistor R2 essentially shorts out the output.

Values of β vary widely for various transistors—from about 15 to more than 200. However, if a designer or experimenter learns to

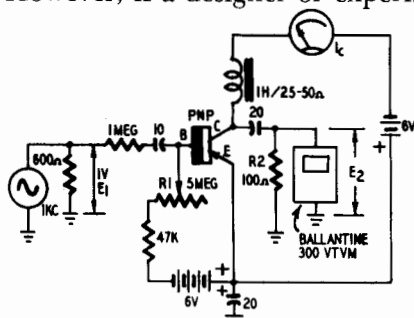

Fig. 405. Circuit for measuring beta. Values of beta vary widely.

use transistors with an interim β spread, say 18 to 36 (some designers like 25 to 50), which is good practice, and designs accordingly, the service technician or experimenter can replace or interchange transistors without much difficulty if he uses units with the same β spread. If the original design requires transistors with very low or very high β factors, replacements cannot be made indiscriminately. Such circuits require especially selected transistors as replacements; otherwise the circuits do not function. The problem of having to *select* transistors with special characteristics has been a headache in servicing many preamplifier circuits.

The alpha factor (collector-to-emitter current gain for the common-base transistor) need not be measured for two reasons. First, alpha can be calculated if beta is known; that is,

$$a = \frac{\beta}{\beta + 1}$$

Secondly, beta magnifies or amplifies transistor properties more accurately. For example, reconsider the problem of having to

select transistors to make an amplifier work. Specifying a beta spread from about 25 to 50 to obtain reliable amplification describes the situation more adequately than an alpha spread of from about 0.961 to about 0.980.

Output impedance

The output impedance R_{out} of a common-emitter transistor (the dual of a grounded-cathode triode tube) is the other parameter about which information is needed to determine transistor reliability. The value of R_{out} should be large because it decreases with

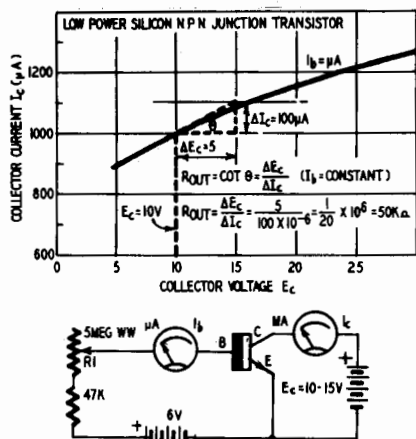

Fig. 406. Measuring output impedance. Impedance values for transistors cover a wide range with an average of about 40,000 ohms.

increasing temperature, high collector currents and voltage and with age.

There are several circuits for measuring impedance, but most of them are lacking in one or more respects. Probably the most economical way to establish the magnitude of R_{out} is to take data for a given transistor and plot the $I_c - E_c$ common-emitter characteristic and then determine R_{out} when I_c is 1 ma and E_c is 10 volts. Fig. 406 shows the process for an n-p-n transistor. R_{out} is the cotangent of the angle θ or the ratio of $\Delta E_c / \Delta I_c$, and varies widely from transistor to transistor. Practical working limits are from about 25,000 to 65,000 ohms, with an average value of about 40,000.

Power transistors

Germanium power transistors have a different design than the

small-signal units just described. Essentially, power units have a larger collector junction area. And since large amounts of heat are liberated in this area (about 1/50 square inch in the Minneapolis-Honeywell type 2N57 p-n-p power transistor), adequate cooling must be provided. Otherwise, the junction would overheat and be destroyed. The 2N57 is cooled by mounting the collector junction on a copper stud. Then the stud (Fig. 407) is attached to a metal chassis (heat sink) to permit rapid dissipation of heat. The photograph, Fig. 408 shows a 2N57 attached to a chassis. Because of this design, the 2N57 is rated at a dc collector dissipation of 20 watts, of

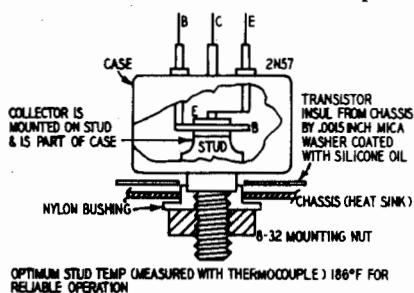

Fig. 407. Diagram shows how to attach 2N57 power transistor to the chassis. This mounting method permits rapid dissipation of heat.

which 6 watts theoretically, can be converted to useful ac output power.

Measurements of I_{co} and I_{cbo} for power transistors are made with the circuits of Figs. 401 and 402. But a milliammeter is substituted for the microammeter and a larger battery is used. The manufacturer specifies that I_{co} for the 2N57 shall be less than 5 ma with -70 volts between collector and base at room temperature, and I_{cbo} shall be less than 27 ma with -70 volts on the collector.

Since available radio components will not handle the large currents passed by some high-power transistors, probably the best gain parameter to measure is current gain (dc). For example, attach a 2N57 to a chassis in the common-emitter circuit (Fig. 409). With E_c at 2.5 volts, adjust R1 until I_c is 100 ma. The current gain,

$$\beta = \frac{I_c}{I_b}$$

should fall between the limits of 10 and 20 for good transistors. For the dc current gain measurement of other power transistors,

check the data sheets for the upper limit of I_c and I_b to avoid damaging the transistors or test equipment by excessively large currents (up to 5 amperes in some high-power transistors).

The collector load resistance for most germanium power transistors is determined by the upper design limits of collector voltage and current. For the 2N57 these limits are 60 volts peak, and 0.8 ampere. Thus, collector load resistance for maximum power is $60/0.8 = 75$ ohms. High-powered units rated at 50 to 60 watts dc collector dissipation ($I_c = 5$ amperes) will require load resistances of about 10 ohms.

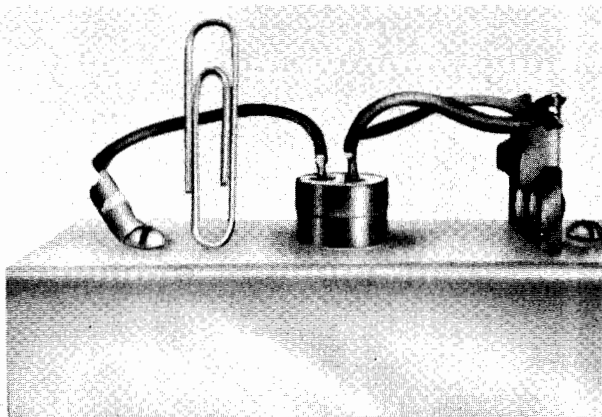

Fig. 408. A 2N57 attached to a chassis. The paper clip furnishes an indication of comparative sizes. The useful ac output power of this transistor is approximately six watts. The mounting technique is an important factor in heat dissipation.

Silicon junction transistors

Available silicon junction transistors are of the n-p-n grown junction type. Their principal value is that they can be used at higher temperatures—around 150° C for example. This is because silicon has a higher energy gap (1.1 electron volts) than germanium (0.72 electron volt). So since the energy gap between filled and conduction bands is large, the intrinsic contribution to conductivity is reduced greatly.

As far as test methods are concerned, we are interested in the same parameters mentioned earlier. The same test circuits can be used (except that battery and meter connections must be reversed for n-p-n transistors).

At room temperatures, I_{co} and I_{cbo} for low- and medium-powered units should be less than $2 \mu\text{amp}$ with 22.5 volts on the collector.

When a silicon unit is operated at 100°C , I_{co} should be less than $12\ \mu\text{amp}$. Noise in silicon units is slightly higher than in germanium units, but is objectionable only in units with high beta factors.

Since β adequately describes the performance of available silicon

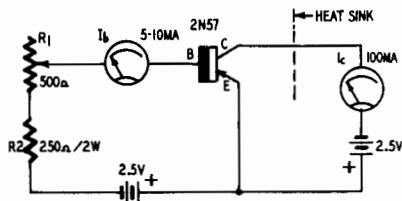

Fig. 409. Measuring current gain (dc).
The current gain (beta) should be between 10 and 20.

units, and since leakage currents are so small, the dc and incremental dc current gain tests can be postponed until high-power (10 watts or greater) units are available.

The spread in β for both low- and medium-powered silicon units is from about 4 to more than 75. There is no official recommendation regarding practical working limits. Some designers and service technicians use an unofficial rule of thumb from about 18 to 36 (as

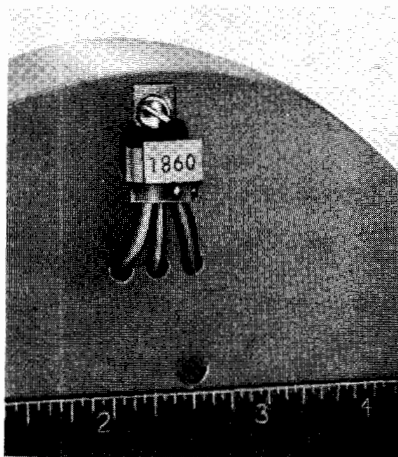

Fig. 410. Silicon junction power transistor attached directly to metal chassis.

measured with 6 volts on the collector).

Output impedances (Fig. 406) of between 15,000 and 80,000 ohms (common-emitter circuit) give satisfactory results. R_{out} varies widely from unit to unit.

The I_{co} and I_{cbo} readings of silicon medium-power units are small. One experimental unit has readings of less than $10 \mu\text{amp}$ at room temperature with 45 volts on the collector. These I_{co} and I_{cbo} readings for the Texas Instrument type X-15 power unit (rated at 1 watt) should be less than $5 \mu\text{amp}$ at room temperature with 45 volts on the collector. A silicon junction transistor attached to a chassis (heat sink) appears in Fig. 410.

Heat sink

A practical consideration worth noting is the requirement for heat removal from the power transistor. Transistor manufacturers' specifications differ widely with respect to the maximum power

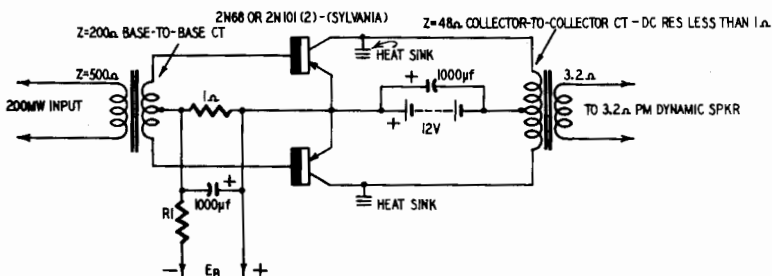

Fig. 411. A power-transistor output amplifier.

which can be dissipated safely in free air. At higher levels, the transistor must be mounted in close contact with a metallic mass (heat sink or dissipator) which will remove heat generated by normal operation. In some instances, a satisfactory heat sink is obtained when the the transistor is bolted to the chassis, provided the chassis has sufficient area and thickness. However, the cooling structure of most power transistors is connected internally to one of the electrodes, usually the collector, and push-pull transistors accordingly cannot be mounted without at least a thin mica insulator between their shells and chassis, otherwise their collectors would be short-circuited by the chassis.

Dc voltage requirements

An attractive feature of the power transistor is its low dc voltage requirement. However, it is as true of power transistors as of other matters that one does not receive something for nothing. High current is the price paid for this low voltage. The high direct

currents of the power transistor impose rather severe requirements on the design of the coupling transformers and on that of the power supply. While on this subject, it should be mentioned that standard, catalogued transformers are unsatisfactory at the low-impedance and high-current levels met in the power transistor. At present, both input and output transformers must either be obtained on special order or built by the user.

The diagram in Fig. 411 shows a typical class-B power-transistor output amplifier stage. Resistor R1 and the battery voltage are selected for a total no-signal collector current of 1 ma. Heavily bypassed emitter stabilization resistors are required if collector current shows a tendency toward "runaway." A typical heat sink would consist of a 25-square-inch chassis, 1/16 inch thick. The maximum-signal current of this stage is 550 ma and maximum power output is 5 watts.

transistor applications

Transistors are finding new and ever-increasing uses. Some of the circuits in which transistors are being applied are well-known through prior employment in conjunction with vacuum tubes. The applications shown in the chapters which follow illustrate some of the more unique ways in which to take advantage of the desirable properties of transistors. The circuits that are described are practical, have been built, tested, and are now in use.

oscillators and triggers

THOUGH transistors generally demand their own circuitry, there are some good vacuum-tube circuits that function nicely when transistors are substituted. As the phase relations of a grounded-emitter transistor resemble those of a grounded-cathode vacuum tube, it is possible to use junction transistors for vacuum tubes in most oscillator circuits.

The multivibrator and the two-terminal sine-wave generator perform well with junction transistors, with the transistorized two-terminal L-C having a great advantage over other transistor oscillators. As with vacuum tubes, the circuit oscillates on higher frequencies than single-transistor oscillators with the same components. While transistors must be selected for other oscillators, most transistors, even those not oscillating in single oscillators, work well on rf in this circuit.

The multivibrator is in principle a two-stage R-C coupled amplifier (Fig. 501). The output voltage of the second tube is fed back to the grid of the first tube. Because of this feedback the circuit starts to oscillate at a frequency determined by the time constants of R and C. The circuit will also oscillate if you substitute an element with similar amplifying and phase-shift relations in place of the vacuum tubes.

Junction-transistor-tube analogy

Before getting into further circuitry, let's discuss the principle of analogy. Fig. 502 shows a junction transistor and a vacuum-tube

triode in common-emitter and common-cathode connections. The symbols e, c and b represent the emitter, collector and base, respectively.

We can immediately draw an analogy between the terminals of

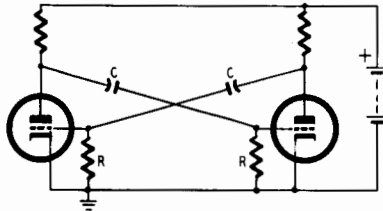

Fig. 501. Basic multivibrator circuit. The operating frequency is determined by the values of R and C.

the two devices: The emitter corresponds to the cathode, the collector to the plate, the base to the grid. The analogy may be extended by noting that an ac signal undergoes a phase reversal between input and output electrodes—base and collector for the transistor, grid and plate for the tube.

If you make the grid of the vacuum tube more positive, plate current increases and as the plate current increases the plate becomes less positive due to the voltage drop across the load resistor. Thus, all “mountains” of a sine wave applied to the grid are transformed into “valleys” of the anode voltage. Now look at the

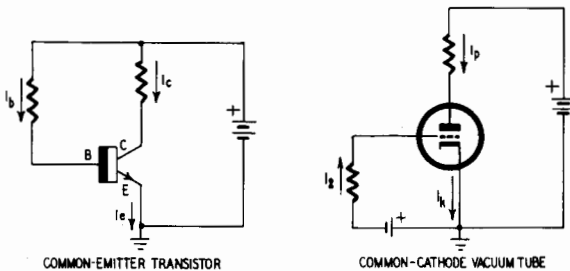

Fig. 502. These diagrams show the basic analogous vacuum-tube and transistor circuits.

grounded-emitter circuit (Fig. 503) of a p-n-p junction transistor. If the base is made more negative with respect to the emitter, collector current increases and the voltage drop across the load resistor causes the collector to become more positive. So, a sine wave is “turned over” the same as with a vacuum tube, a grounded-emitter transistor producing the same 180° phase shift as a grounded-

cathode vacuum tube. Fig 503 shows how the grounded-emitter circuit of a junction transistor corresponds to the grounded-cathode circuit of the vacuum tube.

There are, of course, certain differences between the two. Whereas the grid is returned to a negative source and I_g is zero for normal

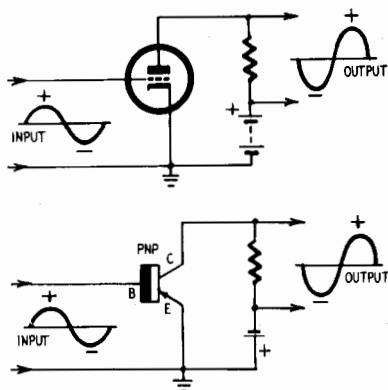

Fig. 503. Tube-transistor comparison. Note phase inversion of the waveform in both instances.

operation, the base return is positive (in transistors with a positive collector) and I_b is not zero. This means that the input resistance of the transistor is not infinite, as is the tube's, but has a finite, actually low, value.

The magnitudes of the output resistances are also dissimilar, the transistors' being much higher than that of the tube. However, as alpha, the ratio of a change in I_c to a change in I_e , increases to unity,

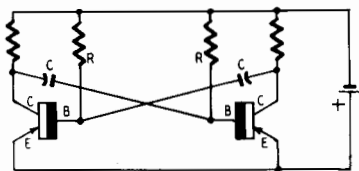

Fig. 504. Transistorized multivibrator. The output has a rich harmonic content.

the differences decrease and the analogy becomes closer. The input resistance of the transistor rises and its output resistance drops correspondingly.

An important difference that does not change with alpha is the input voltage at which conduction begins. For the tube, the grid-

cathode voltage must be more positive than the cutoff level. The transistor, however, conducts only for a base-emitter voltage equal to, or greater than, zero; it is cut off for *all* negative values.

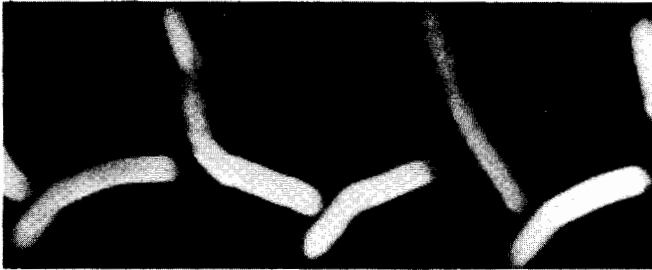

Fig. 505. Multivibrator output pattern showing complex waveform.

Thus, to transistorize a vacuum-tube circuit by analogy, we must make use of the similarities of the two devices and use transistors with alphas close to unity to minimize the differences. The operating principles of the resulting circuits are the same as for their tube counterparts.

Fig. 504 shows the circuit of the transistorized multivibrator. It produces an output waveform rich in harmonics, though they are not as rectangular as those produced by tubes. Nevertheless, there are harmonics up to 30 mc when the circuit oscillates at about 100 cycles. An oscilloscope pattern of the output waveform is shown

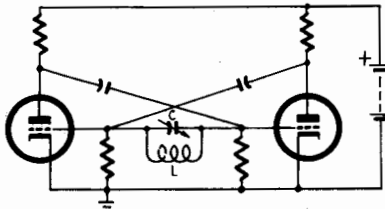

Fig. 506. Diagram of sine-wave generator. This is a two-terminal circuit with the frequency of oscillation determined by the values of L and C .

in Fig. 505. The waveform is more complex than with tubes because the transistor requires input power.

There is a sine-wave oscillator circuit which resembles the multivibrator: the two-terminal circuit of Fig. 506. In principle it is a multivibrator with a resonant L-C circuit between the grids. In the old days of radio the two-terminal oscillator (then called a balance generator) was used because of two advantages: there is no need

for a tapped coil or feedback winding, any resonant circuit connected between the grids will oscillate; the balance generator worked up to very high frequencies even with the poor tubes of those days.

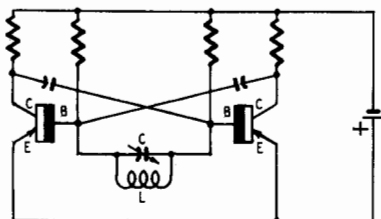

Fig. 507. *Transistor sine-wave generator. Note the similarity to Fig. 506.*

Some say this was the first circuit which ever produced CW in the 2-meter band. Today we have similar difficulties—only a relatively few individual transistors oscillate in the radio-frequency band. It would seem that the balance generator might help to reach higher frequencies even with components not suitable for oscillating in ordinary circuits. It has been found that it is so. The transistorized balance generator (Fig. 507) oscillates over the entire medium-wave band with individual transistors which are otherwise suitable only for audio purposes. If you omit the resonant circuit, you have a multivibrator again. Therefore, it is possible to combine both circuits with the oscillator being used either as a multivibrator or sine-wave oscillator.

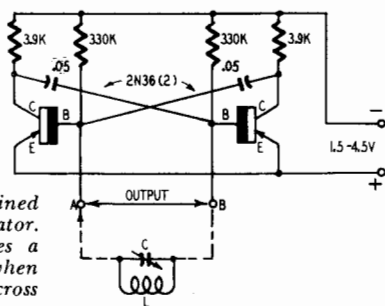

Fig. 508. *Schematic of the combined multivibrator and sine-wave generator. The multivibrator circuit becomes a two-terminal sine-wave generator when the parallel L-C circuit is placed across points A-B.*

The combined circuit

Fig. 508 is the circuit of the combined oscillator. Two CBS-Hytron 2N36 transistors work with grounded emitters. The bias is obtained by 330,000-ohm resistors between the bases and negative supply. In each collector lead there is a 3,900-ohm resistor.

The two .05- μ f coupling capacitors connect the output of each transistor with the base input of the other.

Without any L-C circuit connected to terminals A and B, the circuit works as a multivibrator. The waveform between A and B with the coil-capacitor combination in place is shown in Fig. 509.

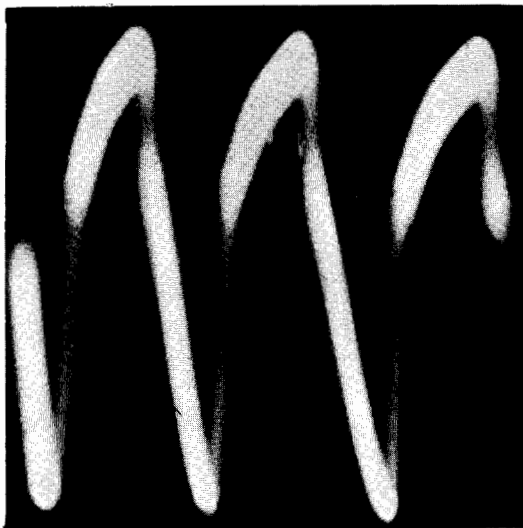

Fig. 509. *Waveform between terminals A-B of Fig. 508.*

The circuit oscillates at about 100 cycles. If you connect terminals A and B to the input of a radio receiver, you will hear the 100-cycle signal over all bands up to 10 meters. Thus the circuit makes an excellent multivibrator for test and alignment purposes. With only a penlight cell used as a voltage source, the unit may be built ultra-compact.

When you connect a resonant circuit to terminals A and B, the oscillator produces sine waves of a frequency determined by the L-C circuit. For low-frequency purposes any capacitor and choke arrangement may be used. The sine wave produced in that case may be seen on a scope. If you want to hear the audio frequency, use your headphones as the inductor. If the capacitor is omitted, higher frequencies will be generated. If the L-C ratio is too high, the sine waves are distorted as shown in Fig. 510.

To use this circuit as an if alignment generator, connect a transformer to A and B. For covering the medium-wave band, any wave-trap or crystal set may be used. The battery voltage may be as little as 1.5, though higher voltages of about 4.5 are desirable to obtain higher output on high frequencies. With a battery voltage of about

4.5, a current of 1 ma will be drawn by the circuit when oscillating, which increases to 2 ma when oscillation ceases. The sine-wave output between A and B is about 2 volts rms at 100 cycles, decreasing to about 0.5 volt at 1.5 megacycles.

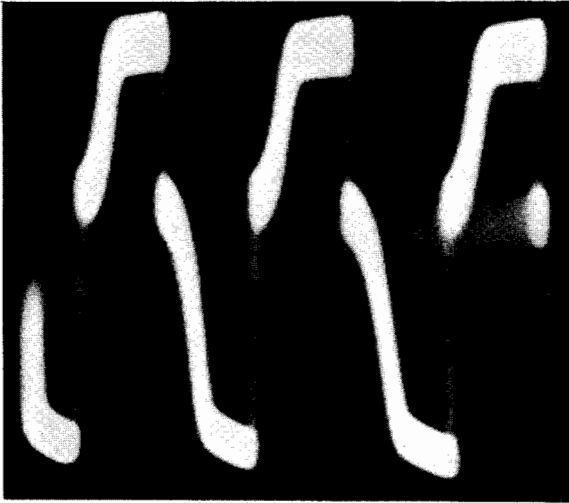

Fig. 510. Distorted sine-wave pattern produced when the ratio of L to C is too high.

Construction

The unit is laid out so that it can be easily soldered into any hookup. The layout may be seen in the photo, Fig. 511. A 2 x 3-inch polystyrene sheet serves as a "chassis." Only four soldering connections have to be made if the oscillator is connected into any larger hookup. When assembling the unit be careful not to apply excessive heat to the transistors when soldering.

As it is much easier to get transistors oscillating with this circuit, it should be of interest to everybody interested in experimenting with transistor oscillators at high frequencies.

Trigger circuits

Trigger circuits are an indispensable part of modern electronics. We find them not only in such complex equipment as radar sets and digital computers, but also in the "ordinary" devices that the radio and television technician is and will be called upon to service—black-and-white and color television, the multiplex radio sets of tomorrow and many others which are as yet still in the dreams of design engineers.

The transistor is having a profound influence on such developments and thus transistor trigger circuits are of prime interest. Investigations have almost exclusively aimed at the point-contact type in the past, because of its inherent negative resistance. Progress was less encouraging than anticipated and research is now being directed almost entirely toward the several types of junction transistor.

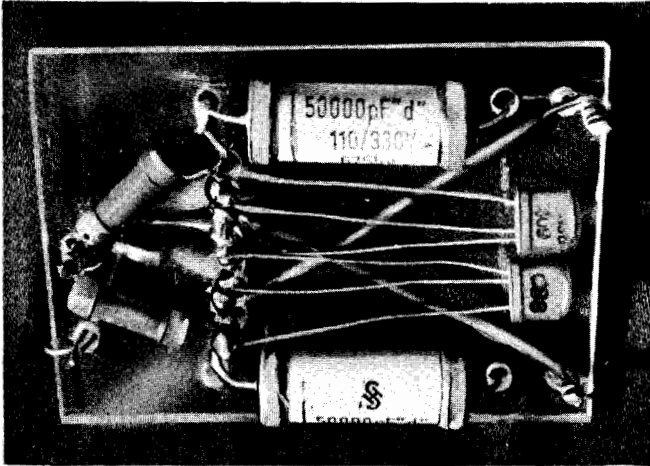

Fig. 511. Polystyrene-mounted multivibrator-sine-wave generator. The plastic chassis is 2"x3".

Junction types hold more promise for several reasons: They are more rugged and reliable than point contacts and, due to present manufacturing emphasis, are readily available. Earlier it was stated that junction circuits can be designed by analogy with conventional tube circuits; the tried and proved techniques of vacuum-tube practice can be almost painlessly carried over to transistors.

In this chapter we have three trigger circuits developed by the analogy method. Each has different applications: the bistable multivibrator is a gating device, the one-shot multivibrator produces a gate of variable duration, the blocking oscillator generates short pulses. Type 2N98 n-p-n junction transistors are used because the high collector supply voltage and high pulse output with good rise- and decay-time characteristics are particularly suited for these and similar switching circuits. Thus the figures all show n-p-n rather than the more common p-n-p circuits.

Bistable multivibrator

The transistor version of the popular bistable multivibrator is shown in Fig. 512. Feedback is provided by the dc coupling from

collector to base, through the voltage divider (the 22,000- and 8,200-ohm resistors) and through the 680-ohm common-emitter resistor. This differs slightly from the usual tube circuit where the common-cathode resistor is omitted and the shunt arms of the divider are returned to a negative voltage. Actually, the 680-ohm resistor, in addition to biasing the *off* transistor beyond cutoff,

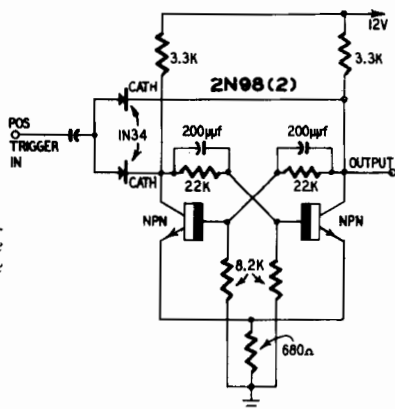

Fig. 512. The bistable multivibrator. The values of the capacitors across the 22,000-ohm resistors may have to be determined experimentally.

stabilizes the *on* transistor and aids the start of regeneration whenever a trigger pulse is received.

The 200 µf speedup capacitors allow rapid changes, such as trigger pulses, at the collectors to be coupled immediately to the opposite base and, therefore, also help start the switching action. Their values are determined experimentally.

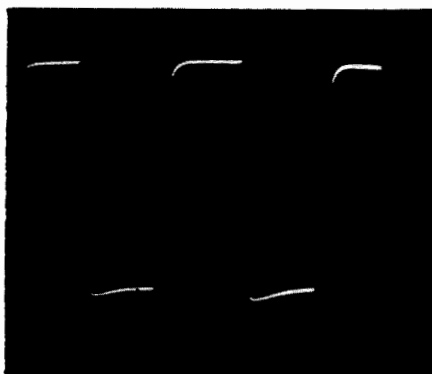

Fig. 513. Output waveform of bistable multivibrator at 100 kc, 10 volts p-p.

Although the triggers are shown applied through the isolating diodes, to the collectors, other points could have been chosen.

The output waveform of the device is shown in Fig. 513. The peak-to-peak amplitude is approximately 10 volts and the repetition

rate 100 kc. This does not represent the maximum frequency at which the circuit will operate. The photograph was taken while the circuit was still on a breadboard, where no particular attention was given to circuit dress.

One-shot multivibrator

The emitter-coupled circuit shown in Fig. 514 is derived from the cathode-coupled tube version. There are two advantages of this

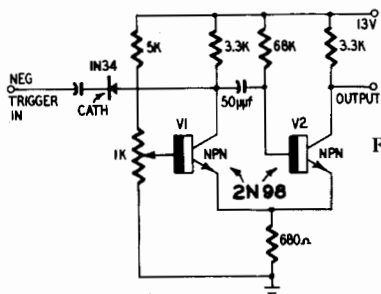
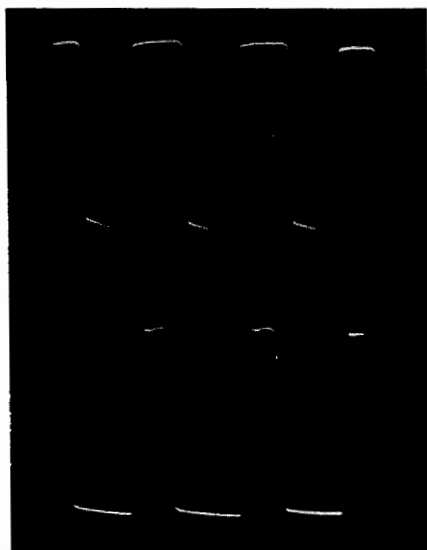

Fig. 514. This emitter-coupled circuit is a one-shot multivibrator.

over other types of one-shot multivibrators—it is highly stabilized by the common-emitter resistor; the width of its output pulse can be easily controlled by varying the setting of the 1,000-ohm poten-

Fig. 515. Output waveform of one-shot multivibrator, 10 volts p-p.



tiometer. Stabilization is obtained by the negative feedback produced by the 680-ohm resistor when the circuit is not in transition (switching states). Control of the pulse duration is not quite so obvious.

In the stable state V2 is *on* because its base return, through the 68,000-ohm resistor, is positive. When a negative trigger is applied, through the isolating diode and the 50- μ f coupling capacitor, the circuit switches to its quasi-stable state—V1 *on* and V2 *off*.

At the end of the transition, the timing action begins as the capacitor charges. This causes the base of V2, which has been driven negative, to rise toward the 13-volt supply. This rise continues as

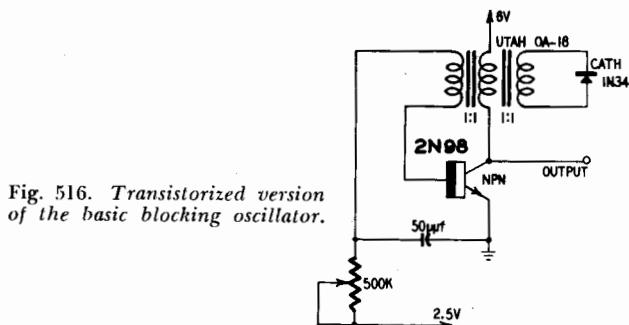

Fig. 516. Transistorized version of the basic blocking oscillator.

long as V2 is off, i.e., until the base attains the emitter voltage. But the emitter voltage is developed across the common-emitter resistor and is equal to the difference between E and the base-emitter drop

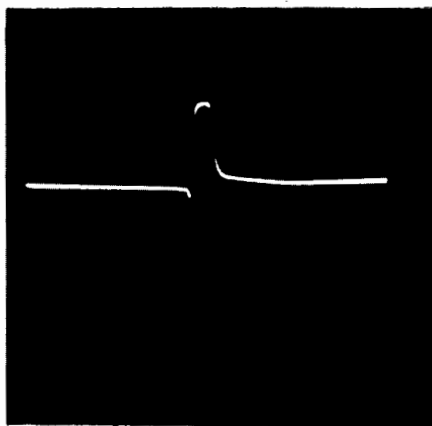

Fig. 517. Output waveform of blocking oscillator at 60 kc, 2.5-microsecond duration.

of V1, the *on* transistor. For all practical purposes, the base-emitter drop of a conducting transistor is zero. Thus, the voltage of the emitter of V2 is E. The base, therefore, rises until it reaches E volts, at which time the circuit flips back to its original state. Thus, the

duration of the output pulse is determined by the magnitude of E and can be varied by changing the potentiometer setting.

This is demonstrated in Fig. 515 which shows the output waveform at two values of E . For each, the amplitude is approximately 10 volts peak-to-peak and the triggering rate is in the order of 100 kc.

Blocking oscillator

The transistorized version of this familiar circuit, as shown in Fig. 516, is free-running. The time between pulses is controlled by changing the setting of the variable resistor or the value of the 2.5-volt source. This can be seen by considering the timing process.

During the pulse, the capacitor charges. The charge, after the pulse has terminated, biases the transistor beyond cutoff. As the capacitor now discharges through the variable resistor, the base rises toward 2.5 volts. When it reaches zero, the transistor conducts and another pulse is generated. The off period is thus determined by the slope of the discharge curve, which in turn is a function of the capacitor, the variable resistor and the 2.5-volt power supply source.

Fig. 517 shows the 6-volt output pulse at a repetition rate of 60 kc, having a duration of 2.5 μ sec. Ringing is prevented by the damper diode across the transformer tertiary, which acts to short out the positive excursion of the oscillation.

The waveform is remarkably free from jitter as compared with a tube blocking oscillator. Jitter is caused by fluctuations in the conducting potential. The transistor conducts a zero base-emitter voltage and the total variation of its conducting potential is very small. However, the cutoff level of a vacuum tube may readily change by large amounts.

The principle of analogy provides us with a powerful method of design. We can directly transistorize tube circuits. It is especially applicable to trigger circuits and brings us that much closer to the time when the technician will be servicing transistor radios and television sets daily.

transistor dc transformer

A BATTERY is a low-impedance source of power. It is most efficient and economical when supplying low voltage at high current. For example, a single No. 6 dry cell may be discharged at a rate of 2 watts or more, yet have a reasonable life span. Compare this with a penlight cell which has a recommended discharge rate of only 35 mw. Sixty penlight cells produce the same power output as a single No. 6 cell which costs about 66¢. The 60 cells would cost \$6.60.

If we were to consider the purchase of dry cells on the basis of expected watts output per dollar, then it is fairly obvious that it would be foolish to use sixty penlight cells in place of a single No. 6. However, we do not need to accept the limitations imposed by various types of dry cells. We can do this by placing a suitable "connecting link" between the circuit we wish to operate and the power source. Although not a transformer in the true sense of the word, the proposed link would have one very desirable transformer property—that of impedance matching.

Dc transformer advantages

The expense of battery power could be drastically cut with the aid of a "dc transformer." Such a device should have a low-impedance input to match the battery source and a high-impedance output to match a high-impedance load. For example, we might take 1 ma from a single size-N cell. With a 1:10 dc transformer (and no losses) the output would be 15 volts at 100 μ a. The N cell would hardly

feel its light load and it would last many hundreds of hours. Yet it would provide the equivalent of a small 15-volt battery. The N cell costs 6c. The smallest 15-volt battery listed in the catalogs (size Y10) sells for 72c. If our load required only the 100 μ a assumed above, the single N cell would be sufficient.



Fig. 601. One of the functions of a dc transformer.

A dc transformer has other advantages. The circuit, having limited power input, cannot produce dangerous voltage or current peaks. Short circuits or wiring errors cannot blow out delicate filaments or endanger instruments in associated circuits. Furthermore, in many cases one or two dry cells are already available for other purposes, such as energizing a filament, and can be used to furnish power.

The dc transformer circuit

Fig. 601 shows basic elements of a transformation circuit, which converts the dc from a battery to ac. This may be a transistor audio

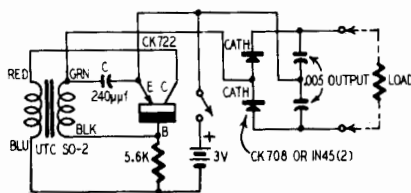

Fig. 602. Schematic of the transistor dc transformer. A CK722 unit is used. The circuit is that of a conventional feedback audio oscillator.

or ultrasonic oscillator. The ac is stepped up as required, then rectified. A transistor is a logical choice for dc to ac conversion because of its efficiency and small size. Voltage multiplication and rectification can be combined with a voltage doubler.

In designing a transistor oscillator the first circuit that comes to mind is a Hartley with a center-tapped coil. A push-pull transformer is used. The tapped winding becomes the Hartley tank. The other coil is thus freed for ac only and for matching the impedance of the load.

However, this scheme of using a Hartley oscillator did not work. The main difficulty arose from the fact that it was very hard to find a satisfactory push-pull transformer in the price and size range desired. There is no reason, though, for insisting upon a Hartley circuit when there are so many other oscillators that are completely suitable.

Operation of the dc transformer

Fig. 602 shows the final circuit. It is a conventional audio oscillator with a capacitor isolating the secondary. This gives a series-resonant network which can step up voltage. The potential across



Fig. 603. Inside view showing how the miniaturized components are mounted.

the coil or capacitor is many times greater than the total voltage between emitter and base. You can light a neon lamp with the voltage across the 240- μf capacitor (which has been multiplied more than 10 times) by feeding it to the voltage doubler. Fig. 603 shows how the miniaturized components are mounted. A front view of the unit is shown in Fig. 604.

As C is reduced, the oscillator frequency rises and so does the stepped-up voltage. If C is made too small, oscillations cease altogether. A small capacitor here may also send the frequency above audibility. The base resistor is another component that may call for trial and error. The smaller it is, the greater the current through the transistor. With a CK722, the maximum flow should not exceed

5 ma. The smaller this resistor, the greater the output power. With the values shown in Fig. 602, the input to the transistor is about 3.8 ma.

Load tests

After completing the instrument, it may be tested to find the optimum load by connecting various resistors across the output while measuring output voltage and current. The product of these two gives output power. Here are the results obtained, with two type N cells as the supply source.

Load (megohms)	volts	Output μ a	mw
0.12	17	150	2.6
0.18	23	130	3.0
0.22	28	125	3.5
0.27	30	110	3.3
0.33	32	95	3.0
0.62	40	74	2.9
1.10	45	50	2.3

Optimum power is obtained with a load of about 220,000 ohms.

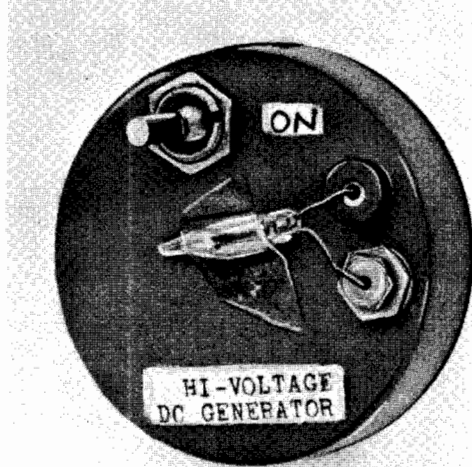

Fig. 604. Front view of the high voltage dc generator. The neon lamp acts as indicator.

The open-circuit voltage is nearly 70. Short-circuit current is about 250 μ a. Maximum output power is 3.5 mw for an input of about 10 mw.

Ripple

Ripple is present in this circuit, but for most applications this is not a problem. If pure dc is necessary, an R-C filter may be added. A large capacitor (.01 to 0.1 μf) across the output terminals will also help. If the frequency is above audibility, it cannot cause difficulty in any audio circuit.

Most diodes pass considerable current in the reverse direction. For example, they may permit several hundred μa to flow at 50 volts. Since this instrument is a low-power affair, even the smallest drain lowers the output voltage considerably.

The output power of this circuit can be raised by using *two* diodes for each one shown in Fig.602. Evidently this lowers the power lost through the rectifiers, for it permits higher output. If you have several rectifiers on hand, try them all—choose those that provide greatest output. You may find a considerable difference even among diodes of the same type.

Applications

This dc voltage multiplier is a low-power source but it has many applications. It can ignite a neon lamp, even though the power input is supplied by two tiny dry cells. Use either an NE-2 or NE-51 neon lamp. This gives just about the smallest, most economical source of illumination. The cells cost 12¢ a pair and will last 200 hours or more. The neon glow can be used for signaling, indicating, testing high insulation, etc.

Parts for dc transformer

1—5,600-ohm resistor; 1—240- μf capacitor (see text); 2—.005 μf disc capacitors; 1—CK722 transistor and holder; 2—penlight cells; 2—CK708 or 1N45 diodes; 1—miniature audio transformer, 1:3 turns ratio, 10,000-ohm primary impedance, 90,000-ohm secondary impedance (UTC SO-2 or equivalent); 2—pin jacks; 1—s.p.s.t. switch.

The neon circuit is also useful for stroboscopic work since the lamp flashes on and off quickly and repeatedly as a result of the high dc potential breaking down the neon gas. Then the lamp begins to draw so much current that the voltage drops below the

ignition point. The lamp is extinguished and ready for the next cycle.

The circuit has sufficient power for phototubes. Most gas types (like those used for movie sound) require approximately 70 volts at about 5 μ a. If the phototube is used for audio work, the ripple should be kept very low.

This circuit has been used to power a transistor rf oscillator. The CK722 transistor would not function with less than 10 volts. It took off immediately when connected to the dc voltage multiplier. Still another application is as a voltage source to calibrate and test vacuum-tube voltmeter instruments and scopes.

auto-light control

THIS transistor light control box will take your automobile one more step toward complete automation. It automatically operates the headlight, dash and running lights, turning them off and on as required by light and driving conditions.

A self-generating photocell and CK722 transistor, together with a simple relay circuit, do all the necessary *thinking* and switching. Except for unusual circumstances, the driver will never need to touch the manual light switch.

The circuit is practical. It has been used and tested for more than a year. Three of these control units were built using the same basic design and each has operated completely satisfactorily.

Automobile electronic controls have faced two serious problems: the unreliability and the monstrous power requirements of the vacuum tube. In most cases, the power supply for vacuum tubes is more complicated than the control circuit! And power supplies contain vibrators and other components subject to rapid deterioration. Also, electronic power supplies are extremely inefficient. Only a fraction of the energy consumed reaches the control circuit as useful power.

In contrast, the transistor can operate directly from a car's 6-volt or 12-volt electrical system. The battery drain is in the order of milliamperes; there is no heavy filament drain to run the battery down and the transistor will probably outlast the automobile and remain completely troublefree.

These advantages of the transistor are put to work in the auto-

light control by a simple, reliable, electrical circuit (Fig. 701). In addition, the small size of the transistor permits very compact construction.

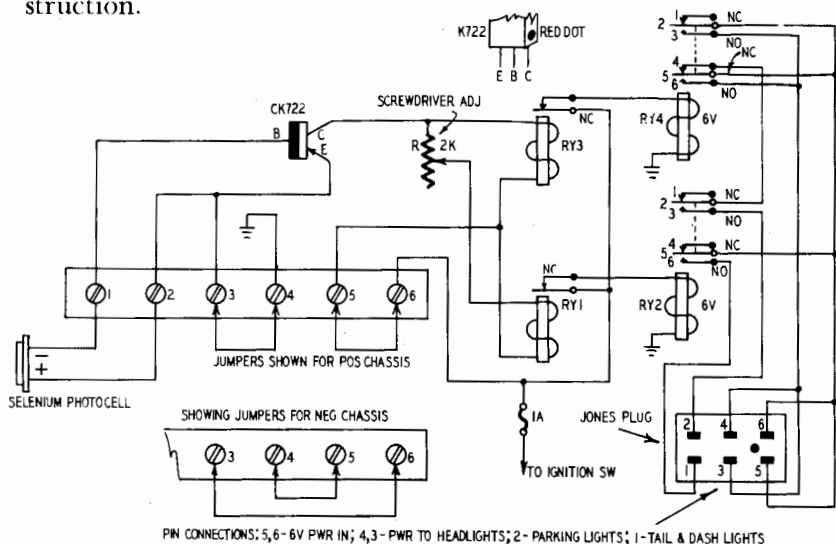

Fig. 701. Schematic shows all wiring for the transistor auto-light control. The symbol NC means normally closed; the symbol NO means normally open.

A self-generating type photocell supplies a dc output that is proportional to the light it receives. The output is amplified by a grounded-emitter CK722 transistor stage. The CK722 amplifies the output of the photocell sufficiently to operate two control relays (RY1 and RY3) in the collector circuit of the transistor. These relays are identical physically. However, one (RY1) is made less sensitive by connecting it to the collector through a series resistance. Because of this, the relay with the series resistance will pass less current and remain open with larger amounts of light pickup from the photocell than will the other.

With no light coming into or striking the selenium photocell, relays RY1 and RY3 are in their normally-closed position as shown in Fig. 701. A small amount of light will operate only the more sensitive of the two relays—that is, RY3, while larger amounts of incident light will work both control relays, RY1 and RY3, and keep the auto lights turned off.

As long as both control relays, RY1 and RY3 are in an open position, RY4 and RY2 are not energized and all automobile lights are off. One side of RY4 and one side of RY2 are connected to ground. This is equivalent to being tied to one terminal of the

6-volt supply. The other connection to RY4 and RY2 is wired to the 6-volt supply through RY3 and RY1. However, as long as RY1 and RY3 are open, RY4 and RY2 do not have a complete circuit to the car battery.

When twilight approaches, there is not enough current to keep RY1 in its open position. When the armature of RY1 is released, it closes the 6-volt power relay RY2. This relay controls the switches on the dash, tail, and parking lights. As it becomes even darker, the armature of RY3 is released. The relay is then in its normally-closed position and this in turn closes the circuit for RY4 and the headlights of the car go on.



Fig. 702. Exterior view of the control box showing the mounting of the Jones plug. The numbering of the male plug terminals is as follows: across the top, from left to right, 2, 4, and 6. Across the bottom, from left to right, 1, 3, and 5. Note the polarizing pin. This prevents incorrect insertion of the plug.

Notice the parking-light current must pass through both RY4 and RY2. Since the dash and tail-light current flows only through RY2, these lights remain on whenever *either* the parking lights or headlights are on. The parking lights turn off when the headlights come on.

For example, the 6-volt power runs from the Jones plug to contacts 2 and 5 of RY4. Relay RY4 is operated by the more sensitive of the two control relays. When RY4 is not energized the 6-volt power can flow only to contact 4 and down to contact 2 on RY2. If RY2 is also unenergized, there is no possible path for the current

to follow and all lights are off. But, if the photocell current drops, RY2 will close contacts 2 and 3 and allow current to flow to the parking lights. At the same time, contacts 5 and 6 also close and operate the dash light and tail-lights.

An even further reduction in photocell output energizes RY4, in addition to RY2, to operate the headlights as contacts 2-3 and 5-6 of RY4 close. This also opens contacts 4-5 of RY4, turning off the parking lights.

The ignition switch controls the current for the transistor and the 6-volt power relays. In this way, the lights cannot be accidentally turned on when the engine is not running.

The wiring from the auto light control box to the car's electrical system is simple. The control box switches are connected in parallel with the manual light control. Fig. 702 shows an exterior view of the control box.

Circuit components

The amount of current available from the selenium self-generating photocell is proportional to the area of the light-sensitive opening. With moderate illumination, some cells deliver 0.5 ma or more into a load of approximately 100 ohms.

Selenium photocells are rugged. They are relatively immune to vibration, heat and electrical fatigue. And, unlike some vacuum phototubes, they are not damaged by extreme illumination. The sensitivity of certain selenium photocells even improves slightly with age. Both the transistor and selenium cell have lives that, for practical purposes, are almost infinite.

The cell for our application should have an area of 2 square inches or more. Smaller cells may be paralleled to give the necessary area.

Special, low-resistance, meter-movement relays are available that will operate directly from the selenium photocell, but relays of this type are very expensive and delicate. Fortunately, one stage of transistor amplification provides enough gain to bridge the power gap between the most sensitive conventional relay and the selenium photocell.

Only the grounded-emitter operation of junction transistors gives an output or collector current greater than the input or control current. The current gain to be expected is given in the collector characteristics (Fig. 703). These are curves published by Raytheon as typical for the CK722. If the reader is familiar with these, he can make intelligent substitutions or modifications of the circuit.

To use the curves, locate the collector-to-emitter voltage, which, for most automobiles, will be 6 or perhaps 12 for some of the newer models. This voltage is plotted along the lower edge of the graph.

If we follow this 6-volt point vertically, we find it intercepts curves drawn for nine values of constant base current—from 0 to 400 microamperes. For example, with 6 volts on the collector and a base current of 100 microamperes, a collector current of 1.6 ma results.

In practice the collector will not be connected directly to the supply voltage—the relay coils will be in series with it.

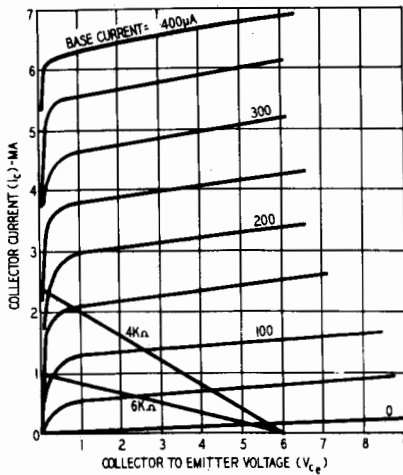

Fig. 703. Characteristics for the CK722 showing different values of base current.

The relay coils have a voltage drop across their terminals when current flows through the windings. The actual collector voltage is the supply voltage minus the drop across the relay coils. With bright light, the current is almost entirely limited by the coil resistance. Thus the load imposes a limitation on the collector current.

We can predict what will happen when a particular relay and transistor are connected together by drawing on the transistor curves a line representing the change in operating conditions caused by the relay coil.

Two 12,000-ohm BK-35 relays, in parallel, are used in the present auto light control. Together they represent 6,000 ohms in series with the collector.

To draw a relay line for 6,000 ohms resistance, we mark two dots

on the graph representing circuit conditions with maximum and minimum current through the coil. The line is constructed by connecting the points with a straightedge. The first point to mark is the collector-to-emitter voltage with zero collector current. Since the drop across the coils is zero with zero current flowing, the first point is 6-volts-0 ma. Maximum current flows with the full 6 volts across the relay. This means the drop across the transistor must be zero. So, the second point is at 0 volt-1 ma. This current at collector

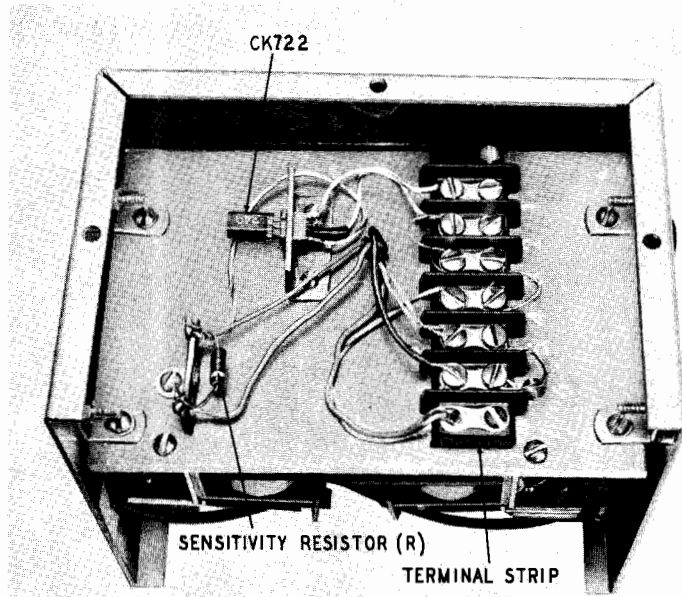

Fig. 704. Underchassis view of the light control. The CK722 transistor is neatly mounted, and the terminal strip wiring is simple.

voltage zero is obtained by dividing the supply voltage by the coil resistance.

Because the collector voltage, for changing values of relay current, runs along the relay load line, we find the collector current from the intersection of the base current curves and the load line. The collector and relay currents are the same.

Remember a base current of 100 microamperes produces a collector current of 1.6 ma without the relay. Now look at the graph. The 100- μ a base current line and relay load line intersect at just a little less than 1 ma. Notice, also that it is impossible for more than 1 ma of relay current to flow. This means the circuit is saturated at light levels above about 100 μ a, while amplification is more linear below this level.

These computations were based on a nominal 6-volt supply. Actually, the supply voltage will run around 6.5. This gives a safety value of amplification greater than the value derived from 6 volts.

To operate the various automobile lights at appropriate light levels, we know 2 square inches of cell surface are necessary. Also, 100 μ a from this area should hold open both relay contacts, turning all car lights off. For 6,000 ohms of relay resistance, this means each relay must close on about 0.5 ma. The BK-35 relays operate on this

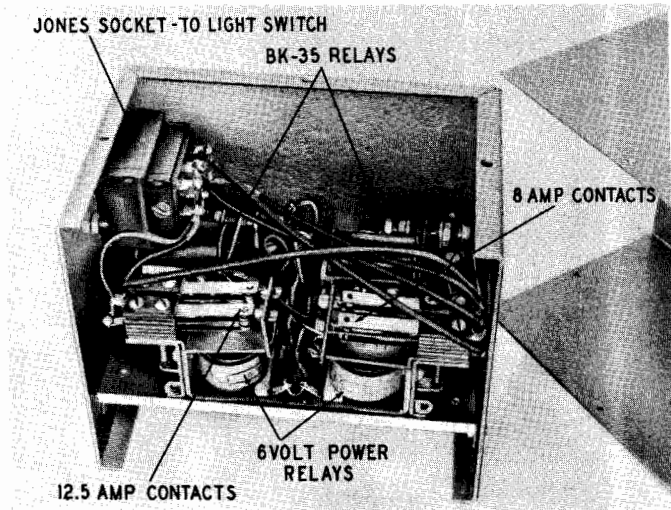

Fig. 705. Topside view shows socket and relays. The wiring is a bit more complex, and all components must be mounted carefully.

amount of current. Other relays such as the Sigma 4F 8,000-ohm relay are easily adjusted to operate on 0.5 ma.

Another load line for the Sigma 4F has been drawn in Fig. 703. Notice the lower resistance of this relay permits higher current gain at the 100- μ a base current intersection.

As a rule of thumb, any relay that can be adjusted to close on 0.5 ma is suitable. To adjust high-resistance relays, say from 8,000 to 12,000 ohms, apply approximately 5 volts to the coil and adjust spring tension until the contacts close. The two relays should be identical. If the relays and coil resistances are dissimilar, it may be difficult to adjust their closures for proper operation of the parking and headlights.

The BK-35's, made by GM Laboratories and obtained as surplus,

are single-throw, normally open relays. For our purpose, the contacts must close when the current is removed from the coil. To do this, the contact and gap-adjusting screws must be swapped, since only one of them has a silver contact. Also, the armature must be turned over to turn the silver contact face in the opposite direction.

Construction

The unit shown in Fig. 704 and Fig. 705 is mounted in a 4 x 5 x 6-inch aluminum case. However, another model was placed in a smaller 3 x 4 x 5-inch steel case. There was not enough room in it for the Jones plug and a screw terminal strip had to be used in its place. The unit used in the model shown in the photographs is a high-current, 400-series Jones plug.

Parts for auto-light control

1—2,000-ohm potentiometer (see text); 2-relays, BK-35 (12,000 ohms) or Sigma 4F (8,000 ohms), (must close on 0.5 ma); 2-relays, 6 volts d c, Guardian 200 series (one should have 12.5-ampere contact assembly; other an 8-ampere); 1—CK722 transistor and socket; 1—photocell, selenium, DP-5 (International Rectifier Corp.) or equivalent (see text); 1—Jones socket and plug; 1—screw terminal strip; 1—fuse, 1 ampere, and holder; 1—2-foot length of shield braid; 1—aluminum cabinet.

All construction should be rigid and free from vibration. Lock washers must be used and nuts and bolts tightened securely. The relay armatures of the sensitive control relays should move in a horizontal plane free from gravitational pull or up-and-down vibrations.

Relays RY2 and RY4 are the Guardian Universal 200 series. Six-volt coils are used. The contacts for RY4 must be the 12.5-ampere type—the contacts for RY2 may be the smaller 8-ampere variety. Any 6-volt relays capable of handling this much or more current will be O.K. if they do not pull too much current for the sensitive-relay contacts to handle. A 12-volt electrical system, of course, will require 12-volt coils.

Wiring from the Jones socket to the power relays must be flexible yet able to carry large currents. The braid from shielded grid wire—insulated with plastic spaghetti—is ideal for this purpose.

The leads from the photocell enter the case through a grommeted

hole and connect to a terminal strip (Fig. 701). For the CK722 to operate at all, the negative pole of the self-generating photocell must connect to terminal 1. Do not use the automobile chassis as a return for the photocell. Run a twisted pair directly from the photocell to the proper terminals.

The jumpers from terminal 3 to 4 and from 5 to 6 are for positive-chassis electrical systems. Join 3 to 6 and 4 to 5 for automobiles with the negative battery terminal grounded. A fused lead connects the

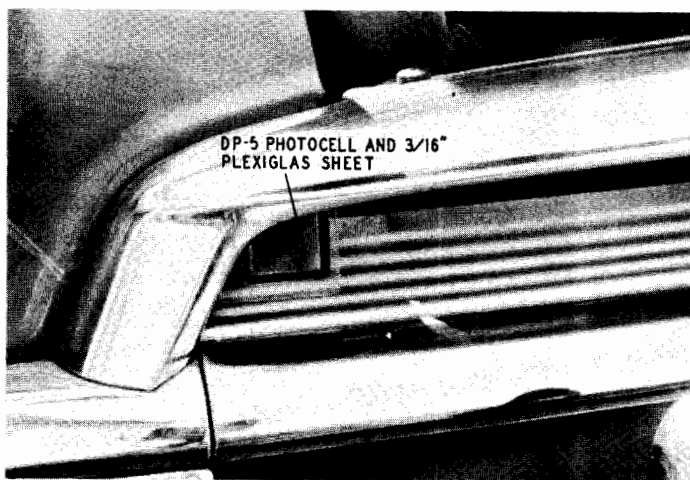

Fig. 706. The photocell is mounted in the grille, with a protective Plexiglas sheet.

power to the control unit from the ignition switch. A 1-ampere fuse is used.

The sensitivity resistor in series with RY1 may be a 2,000-ohm variable potentiometer or a fixed value of resistance determined by experiment. It is possible to make one of the relays less sensitive by increasing its spring tension, but it is better to use the series-resistor method.

Wiring from the Jones plug to the manual light switch should be at least as large as the existing wiring. Wires carrying 6-volt power to the switch and from the switch to the headlights are heaviest. Most automobiles have the dash light and tail lights on one circuit and the headlights and parking lights on two others. Except for the sprained back and bruised knuckles acquired by getting at the manual switch under the dash, it is a simple matter to parallel the automatic contacts with the manual switch.

The photocell can be mounted on the back of the rear-view mirror, facing through the windshield. Or it may be placed in the radiator grillwork. Any reasonable protected location admitting full outdoor illumination is satisfactory (see Fig. 706). It can even be placed on the ledge between the rear seat and rear window and the wires run under the floor mats.

Unmounted photocells, such as those sold surplus, should be mounted in a protected container. Two of these cells paralleled and sealed in a phono-cartridge container were used with one of the control units.

The photocell in the photographs is a type DP-5 made by International Rectifier Corp. Hermetically sealed, it has 2.25 square inches of active surface. The output current is 600 microamperes at 100 foot-candles of illumination and the special sensitivity corresponds very closely to that of the human eye. The price of this cell, a deluxe model, is about \$18. Other photocells can be purchased new, with the same output, for about \$4. Surplus self-generating cells are even cheaper—some sell for less than \$1.

The success of the unit depends largely upon the photocell and the sensitive control relays. If components other than the recommended ones are used, they should be tested in a bread-board layout before final construction is begun.

The use of this circuit is not necessarily limited to automobiles. It could be used in fixed locations to operate such devices as electric signs and yard lights where it may or may not be necessary to use two control relays of differing sensitivities.

geiger counter

ONE of the most unfortunate features of the usual portable Geiger counter is the short life of the expensive high-voltage batteries. These 300-volt units run down very quickly—especially in very hot or humid weather—whether used or not. Here is a portable Geiger counter that operates from only four flashlight cells. A transistor oscillator furnishes high voltage for the G-M tube while a two-stage transistor amplifier drives the headphones.

The unit is built into a standard 3 x 4 x 5-inch aluminum two-piece cabinet and weighs 2½ pounds with batteries installed. Fig. 801 shows the outside appearance of the unit. Battery life is well over 150 hours of continuous operation. Three standard low-cost junction transistors are used along with a 300-volt G-M tube and one low-drain filament type diode rectifier.

Circuit operation

Fig. 802 shows the circuit. Transistor V1 and the audio transformer comprise the 1,000-cycle blocking oscillator. An extra winding of 125 turns of fine wire is placed on the transformer for feedback in the oscillator circuit. The 0.25- μ f capacitor couples the feedback winding to the transistor base while an 18,000-ohm resistor provides correct bias. The secondary voltage of the transformer is rectified by the 5799 diode while a single .05- μ f 600-volt capacitor provides complete dc filtering. A voltage regulator consisting of one 4.7 megohm resistor and four NE-2 neon bulbs in series keeps

the voltage output at approximately 300 to compensate for variations in battery input voltage.

This 300 volts dc is applied to the G-M tube and the base-emitter circuit of transistor V2 in series. Discharge impulses of the G-M tube are thus applied to the first transistor amplifier and are in turn amplified again by transistor V3 which drives the headphones. A 1,000-ohm resistor and a 10- μ f capacitor in the amplifier battery lead

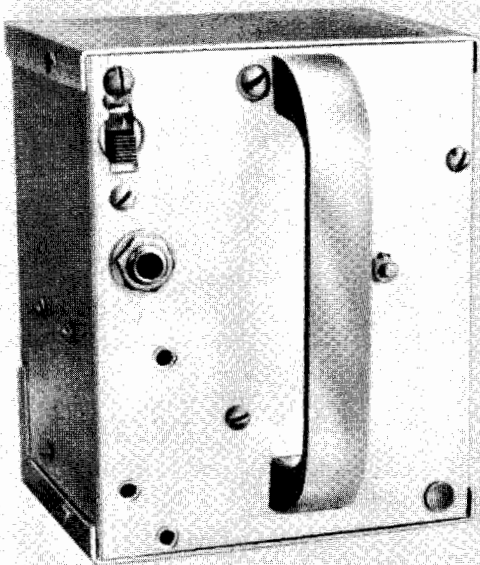

Fig. 801. Exterior view of the transistor-operated Geiger counter. It is light and portable. The unit has long operating life, uses ordinary size-D flashlight cells for power.

act as an audio-frequency filter to decouple the oscillator from the audio amplifier.

Construction details

All parts are standard. The transformer, a Merit A-2918, is the only one requiring modification. It is a line-to-grid unit with a 100-ohm primary and 400,000-ohm secondary, with 125 turns of No. 36 (or smaller) enameled copper wire wound over the existing windings and leads. It may be necessary to remove a layer of the kraft paper covering the original windings to make room for the added

winding. However, the old windings and their terminal leads need not be disturbed. Cover the added winding with Scotch tape before replacing the core. When wiring this transformer into the circuit, see Fig. 803 for correct phasing of the leads. This guarantees oscillation and provides peak voltage output from the secondary winding by using the higher side of the unsymmetrical output waveform.

All parts should be fastened securely, preferably with terminal strips. Placement is not critical, the only shielding necessary is a piece of 1/16-inch aluminum sheet between the transformer and

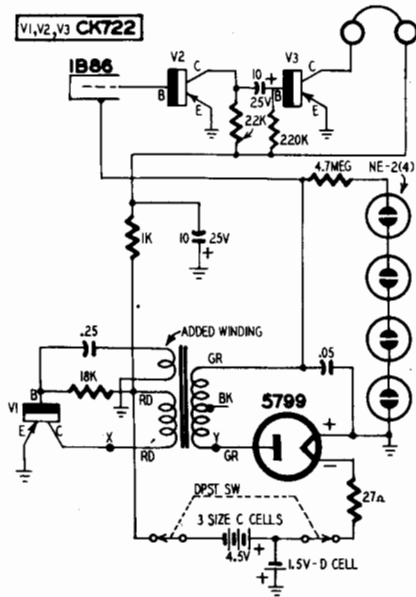

Fig. 802. Circuit diagram of the Geiger counter.

the first transistor amplifier, V2. This reduces electrostatic coupling to a minimum. The oscillator transformer radiates a rather strong magnetic field and if you use a transformer-coupled amplifier instead of the R-C type used here more shielding will be necessary. Be sure and cut a window in the cabinet for the G-M tube. The under-chassis view illustrated in Fig. 804 shows the placement of parts.

Voltage regulation

Other diode rectifiers may be used in the power supply but the

Victoreen 5799 provides the lowest filament drain (8 to 10 ma). Successful rectification was obtained experimentally with a 1T4 connected as a diode and with only 28 ma of filament current. High-voltage selenium rectifiers are the ideal solution but none were available.

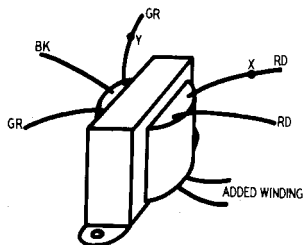

Fig. 803. Coded transformer terminals insure proper connection to the counter.

The voltage regulator is absolutely necessary and prevents too much voltage from “spilling” or continuously discharging—and damaging—the G-M tube.

Correct polarity on the G-M tube is of utmost importance. Reverse polarity will ruin the tube. Note that this particular high-

Parts for Geiger counter

Resistors: 1—27, 1—1,000, 1—18,000, 1—22,000, 1—220,000 ohms; 1—4.7 meg-ohms, 1/3 watt.

Capacitors: 1—0.25 μ f, 200 volts; 1—.05 μ f, 600 volts, paper; 2—10 μ f, 25 volts, electrolytic.

Miscellaneous: 3—CK722 transistors; 1—5799 diode (Victoreen); 1—1B86 G-M tube (Victoreen); 1—af input transformer, primary 100 ohms, secondary 400,000 ohms ct (Merit A-2918 or equivalent); 4—NE-2 neon lamps; 1—3 x 4 x 5-inch aluminum chassis; 3—size-C, 1—size-D flashlight cells; phones, terminal strips, hookup wire, hardware.

voltage supply has the positive side grounded and the G-M tube must be connected as shown for proper operation. Note also the flashlight battery supply has the positive side grounded. Three size-C cells and one D cell are used in preference to four size-C cells to equalize service life as the lower or ground-end cell must supply

filament current to the 5799 as well as transistor current. A battery box may be constructed for ease of battery replacement or the cells may be wired together permanently. A 7.5-volt battery (Eveready No. 773 or equivalent) may also be used but life will be reduced.

Feedback polarity

After all other wiring has been completed correct polarity for the added feedback winding must be determined. Incorrect polarity prevents oscillation and may send excessive collector current

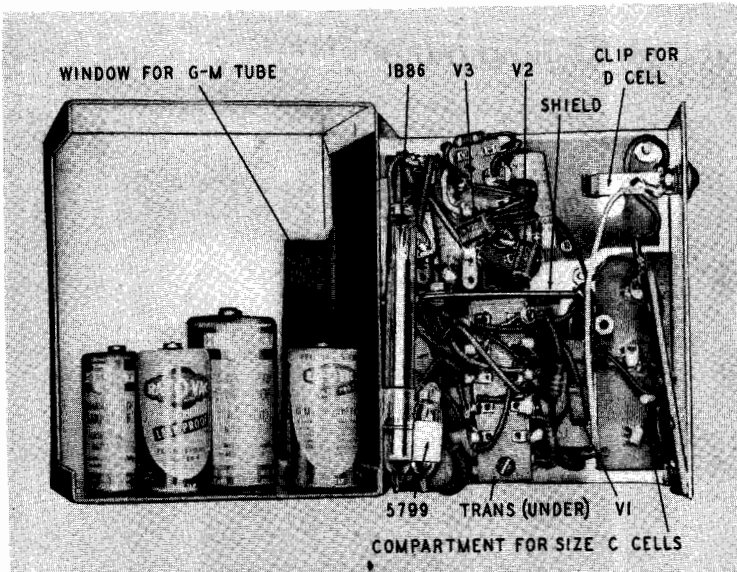

Fig. 804. An underchassis view showing major parts. A slot in the case forms a window for the G-M tube.

through V1. To check polarity insert the flashlight batteries and carefully turn on the power switch. If the neon voltage-regulator tubes do not light *immediately*, quickly turn off the switch and reverse the feedback winding leads. When the neon bulbs light, the power unit is functioning properly. To check the high-voltage dc output use a meter with 20,000-ohms-per-volt sensitivity, or better, set on the 1,000-volt scale. A reading of 300 to 320 volts is satisfactory. When the circuit is operating correctly, the following currents are typical: Blocking oscillator collector current 4 to 6 ma; 5799 filament current 8 to 10 ma; total amplifier current with ear-phones inserted 0.2 ma.

Using the counter

Operation is simple. Turn on the power and listen for the normal background counting rate (approximately 30 clicks per minute). The clicks should be clear and crisp while the only other sound should be the normal background transistor noise (a soft hiss). The 1,000-cycle note of the blocking oscillator should be only barely audible in the output. A radioactive source, such as a luminous watch or clock face, brought near to the G-M tube will increase the counting rate appreciably.

Headphone impedance may be anything from 600 to 20,000 ohms; however, the higher impedances work best.

The completed unit makes an ideal field Geiger counter. It is light, portable and is powered with easy-to-obtain flashlight batteries. The life of the transistors is estimated to be over 10,000 actual working hours. Battery life computed at 2 hours service per day, 7 days per week, will exceed 20 days of operation!

index

A

Advantages of Dc Transformer.....	71
Age	46
Alpha	18
Alpha Factor	50
Amplifier:	
Circuit, Unstabilized	37
Power-Transistor Output	55
Response of Stabilized	37
Stabilized Transistor	36
Stage, Resistance-Capacitance	
Coupled	38
Tetrode Bandpass	43
Analogy, Junction-Transistor-Tube	59
Audio-Amplifier Layout, Transistor	11
Auto-Light Control	77
Automobile Electronic Controls	77
Average Value of Current Gain.....	17

B

Back Resistance	15
Balance Transistor Checker, Null.....	20
Bandpass Amplifier, Tetrode.....	43
Base Current Bias	33, 49
Base 1 Input Tetrode Using	38
Base Resistance	45
Base-to-Emitter Resistance	19
Basic Operation	19
Battery Polarity	13
Beta	18, 35, 41
Beta Gain	18
Beta, Measuring	50
Beta vs. Base 2 Current	41
Bias, Base-Current	33, 49
Bias, Fixed	33
Bistable Multivibrator	66
Blocking Oscillator	69, 70
Blocking Oscillator in Geiger Counter.....	87
Blocking-Oscillator Waveform	69
Board, Layout	13
Box, Transistor Light Control	77

C

Calibration of Transistor Checker.....	23
--	----

Characteristics:

For the CK722	81
Transistor	34, 45
Transistor Static	49
Checker:	
Circuit, Transistor	27
N-P-N Transistor	30
P-N-P Transistor	29
Procedures, Transistor	28
Setup for Transistor	28
Checker:	
Calibration of Transistor	23
Construction of Transistor	21
Null Balance Transistor	20
Parts for Transistor	19
Use of Transistor	23
Checking N-P-N Transistors	24
Circuit:	
Components for Light Control	80
For Determination of Stabilization	36
For Measuring Tetrode Transistor	
Dc Characteristics	40
For Self-Bias Operation	34
Light-Control	78
Multivibrator	60
Of the Dc Transformer	72
Of Junction Transistor Checker	20
Operation of Geiger Counter	87
Transistor Check	27
Unstabilized Amplifier	37
Circuits, Low-Frequency Transistor	37
Circuits, Trigger	65
Class-B Power-Transistor Amplifier	55
Collector Current	29, 35
Collector Load Line	34, 35
Collector Load, Power Transistor	52
Components for Light Control, Circuit	80
Conductance	38
Constant Current	19
Construction:	
Details for Geiger Counter.....	88
Of Auto-Light Control	84
Of Transistor Checker	21
Control, Auto-Light	77
Control, Circuit Components for Light.....	80
Control Circuit, Light	78
Control Unit, Voltage	11
Conversion, Dc to Ac	72
Counter, Geiger	87

Current:			High-Frequency Response of Transistor	38
Bias, Base	33,	49	Circuits	71
Collector	29,	35	High-Voltage Dc Generator	87
Constant	19		High-Voltage Requirements for Geiger Counter	23
Drain	10			
Feedback	35			
Gain	18,	45		
Gain, Small-Signal	41			
Leakage	35			
Current Gain:			I	
Ac	46		Identifying Transistors	14
Average Value of	17		Impedance, Measuring Output	51
Dc	46		Impedance, Output	45,
Currents:			Incremental Dc Current Gain	51
Dc Leakage	41		Inversion, Phase	61
Leakage	45			
Measuring Leakage	46			
Curves, Transistor	81		J	
D			Junction Transistor:	
Dc:			Checker, Circuit of	20
Current Gain	46		Germanium	46
Generator, High-Voltage	71		Silicon	53
Leakage	46		Tube Analogy	59
Leakage Currents	41			
Load Line	34		L	
Operating Point	34		Layout Board	13
To Ac Conversion	72		Layout for Transistor Experiments	12
Transformer Circuit	72		Leakage Current	35,
Transformer, Operation of the	73		Leakage Currents, Dc	41,
Transformer, Transistor	71		Leakage Currents, Measuring	46
Voltage Multiplier, Using the	75		Light Control:	
Derating Transistors	36		Auto	77
Drain, Current	10		Circuit	78
Dry Cells, Using	71		Circuit Components for	80
Duality	49		Line, Collector Load	34,
			Load Line, Collector	34,
			Load, Power Transistor Collector	52
			Load Tests	74
			Low-Frequency Response of R-C Amplifier	37
E			Low-Frequency Transistor Circuits	37
Effect of Temperature	12			
Electronic Controls, Automobile	77		M	
Emitter Input, Tetrode Using	40		Measurements, Transistor	45
Emitter Resistance	45		Measuring:	
Experiments, Layout for Transistor	12		Beta	50
			Leakage Currents	46
			Output Impedance	51
			Small-Signal Current Gain Tetrodes	42
			Tetrode Transistor Dc Characteristics, Circuits for	40
			Transistor Gain	20
			Methods, Test	45
			Mounting a Photocell	85
			Mounting Power Transistors	52,
			Multimeter to Check Transistors, Using a Multiplier, Using the Dc Voltage	27
			Multivibrator	75
			Multivibrator, Bistable	59
			Multivibrator, One-Shot	66
				68
			N	
			Noise, Transistor	48
			N-P-N Transistors, Checking	24,
			Null Balance Transistor Checker	30
			Number, Transistor Type	17
			O	
			Ohmmeter, Checking Transistors with an Ohmmeter, Testing Transistors with an One-Shot Multivibrator	27
			Operating Point, Dc	25
			Operating Values	68
			Operation:	34
			Basic	19
			Circuit for Self-Bias	34
			Of the Dc Transformer	73
			Of Geiger Counter, Circuit	87
H				
Heat Sink	55			

Oscillator:		Stabilizing the Transistor	34
Blocking	69, 70	Static Characteristics, Transistor	49
Power Output	44	Stepup, Voltage	72
Power Output, Tetrode	44		
Tetrode Sine-Wave	44	T	
Waveform, Blocking	69	Temperature, Effect of	12
Oscillators	59	Temperature Sensitivity	45
Output:		Test Methods	45
Amplifier, Power-Transistor	55	Test Unit, Transistor	10
Impedance	45, 51	Testing:	
Impedance, Measuring	51	Load	74
Waveform, Multivibrator	62, 67	Requirements for Transistor	26
P		Transistors	17
Parameters, Transistor	34, 45	Transistors with an Ohmmeter	25
Parts for Transistor Checker	19	Tetrode:	
Performance, Transistor	33	Bandpass Amplifier	43
Phase Inversion	61	Measuring Small-Signal Current Gain	42
Photocell, Mounting a	85	Oscillator Power Output	44
P-N-P Transistor Check	29	Sine-Wave Oscillator	44
Point, Dc Operating	34	Transistor	39
Polarity:		Using Base 1 Input	38
Battery	13	Using Emitter Input	40
Feedback	91	Transformer:	
Of G-M Tube	90	Circuit, Dc	72
Reverse, Effect of on G-M Tube	90	Operation of the Dc	73
Portable Geiger Counter	87	Transistor Dc	71
Power Gain	42	Transistor:	
Power Output, Tetrode Oscillator	44	Amplifier, Stabilized	36
Power Transistor:		Audio-Amplifier Layout	11
Amplifier, Class-B	55	Characteristics	34, 45, 81
Collector Load	52	Circuits, High-Frequency Response of	38
Mounting	52	Circuits, Low-Frequency	37
Output Amplifier	55	Collector Load, Power	52
Voltage Requirements	55	Dc Characteristics, Circuit for	
Power Transistors	51	Measuring Tetrode	40
Procedures, Transistor Check	28	Dc Transformer	71
Protecting Transistors	9	Experiments, Layout for	12
		Gain, Measuring	20
		Light Control Box	77
		Measurements	45
		Noise	48
		Operated Geiger Counter	87
		Output Amplifier, Power	55
		Parameters	34, 45
		Performance	33
		Records	18
		Resistance	28
		Stabilizing the	34
		Static Characteristics	49
		Test Unit	10
		Testing, Requirements for	26
		Tetrode	39
		Type Number	17
		Voltage Requirements, Power	55
		Transistor Check:	
		Circuit	27
		N-P-N	30
		P-N-P	29
		Procedures	28
		Setup for	28
		Transistor Checker:	
		Calibration of	23
		Circuit of Junction	20
		Construction of	21
		Null Balance	20
		Parts for	19
		Use of	23
		Transistorized Multivibrator	61
		Transistors:	
		Checking N-P-N	24
		Derating	36
		Germanium Junction	46
		Identifying	14
		Mounting Power	52
		Power	51
		Protecting	9
		Silicon Junction	53
		Soldering	12
		Stabilization of	35
		Testing	17
		Testing with an Ohmmeter	25
		Using a Multimeter to Check	27
Records, Transistor	18		
Regulation, Voltage	89		
Requirements for Transistor Testing	26		
Resistance:			
Back	15		
Base	45		
Base-to-Emitter	19		
Emitter	45		
Forward	15		
Reverse-Bias	15		
Transistor	28		
Resistance-Capacitance Coupled Amplifier Stage	38		
Response of:			
R-C Amplifier, Low-Frequency	37		
Stabilized Amplifier	37		
Transistor Circuits, High-Frequency	38		
Reverse-Bias Resistance	15		
Reverse Polarity, Effect of on G-M Tube	90		
Ripple	75		
S			
Self-Bias Operation, Circuit for	34		
Sensitivity, Temperature	45		
Setup for Transistor Check	28		
Silicon Junction Transistors	53		
Sine-Wave Generator	59		
Sine-Wave Oscillator, Tetrode	44		
Sink, Heat	55		
Slope of Collector Load Line	35		
Small-Signal Current Gain	41, 46		
Small-Signal Current Gain Tetrodes, Measuring	42		
Soldering Transistors	12		
Stabilization	33, 35, 68		
Stabilization, Circuit for Determination of	36		
Stabilized Amplifier, Response of	37		
Stabilized Transistor Amplifier	36		

Voltages for	9
Trigger Circuits	65
Triggers	59
Two-Terminal Sine-Wave Generator	59
Type Number, Transistor	17
Types of Transistors, Identifying	14

U

Unit, Voltage-Control	11
Unstabilized Amplifier Circuit	37
Using:	
A G-M Tube	89
A Multimeter to Check Transistors	27
A Transistor Checker	23
The Dc Voltage Multiplier	75
The G-M Counter	91

V

Values, Operating	10
Voltage:	
Control Ununt	11
Dc Generator, High	71
Feedback	35
Multiplier, Using the Dc	75
Regulation	89
Requirements, Power Transistor	55
Stepup	72
Voltages for Transistors	9

W

Waveform, Blocking Oscillator	69
Waveform, Multivibrator Output	62
Wiring the Auto-Light Control	84